



# Wibe Cable Trays

For demanding applications

Catalogue 2020  
Cable Support Solutions



[se.com](http://se.com)

Life Is On





# Cable Support is BIM Ready



Discover and download our Cable Support BIM models today by clicking or scanning the QR code.



If you're an architect, engineer, or contractor working on a BIM (Building Information Modeling) project design, you can now take advantage of Schneider Electric's comprehensive and user-friendly online BIM models library.

Here you can download from a wide range of BIM models and benefit from features we provide such as a support system, video explanations, customized selection components, extended-schedule generation, as well as size-error detection.

So rest assured, we have the perfect Cable Support BIM model for you to integrate into your project, so you can benefit from a design process that is intuitive, collaborative, and easy-to-configure.

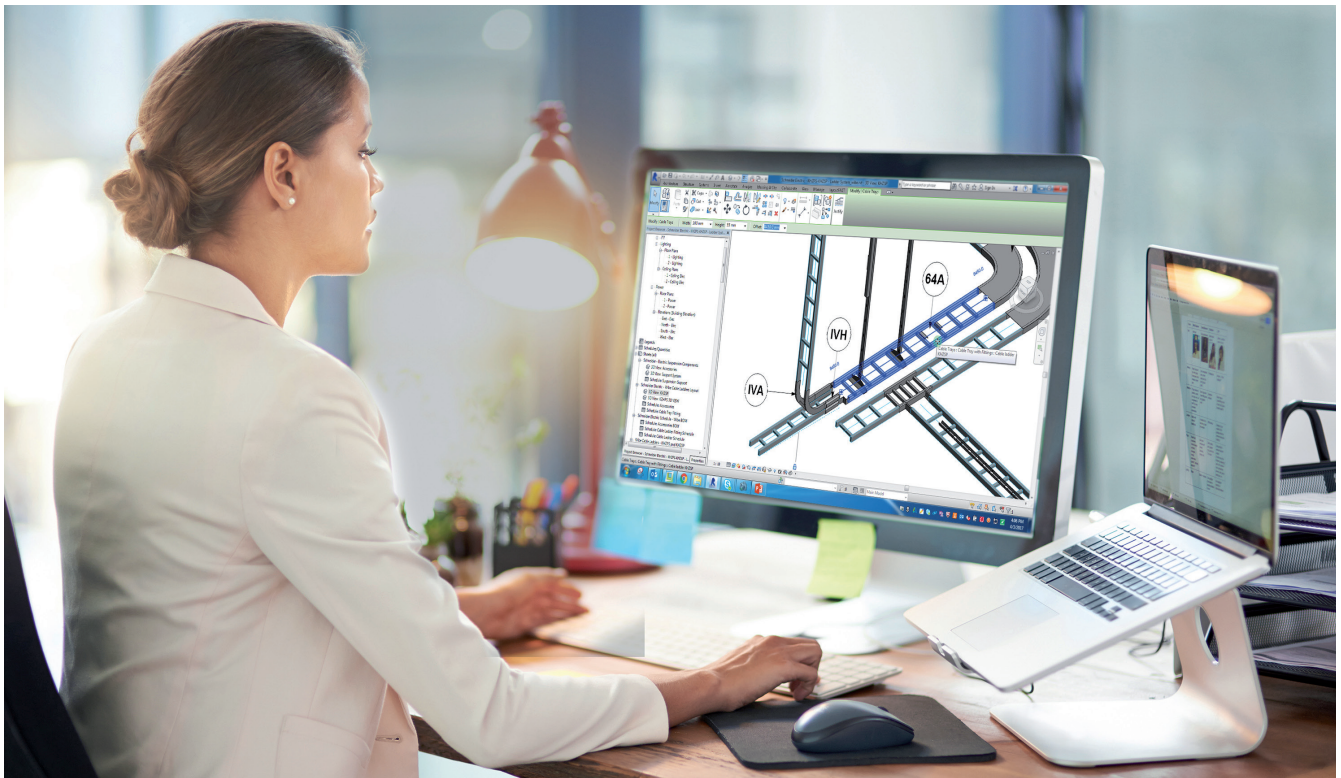

# Content

Corrosion classes.....	6
Surface treatments.....	7
Potential balancing.....	8
Electro-magnetic compatibility EMC.....	9
Installation regulations .....	10
Standards and Quality.....	11
Installation summary .....	12
Suspension components .....	14
<b>Steel cable trays.....</b>	<b>16</b>
Pre-galvanized.....	16
CLX <sup>3</sup> Click suspension.....	34
Pre-galvanized white .....	36
Hot-dip galvanized.....	52
Zinkpox.....	62
Stainless steel .....	72
<b>Technical information .....</b>	<b>77</b>
Use and installation .....	77
<b>Reference number overview.....</b>	<b>156</b>

# 90

years of expertise  
in cable support

# The right surface treatment -crucial for a successful outcome

A cable support installation is considered to be a long-lasting solution and the life expectancy is dependent on the environment in which it is placed. A thorough investigation of the setting in terms of corrosion, pollution, humidity, salt, sanitary regulations etc will help you make the best choice. Our range of cable trays and accessories covers all types of surface treatments, enabling a reliable, cost-efficient and long-lasting cable support solution.

## C1 Electro-galvanized

Indoor environments: Schools, shops, hotels, offices, sports halls etc.

- Very low environmental corrosion.
- Heated areas.
- Arid atmosphere.
- Insignificant quantities of pollutant.
- DIN 50961/ISO 2081.

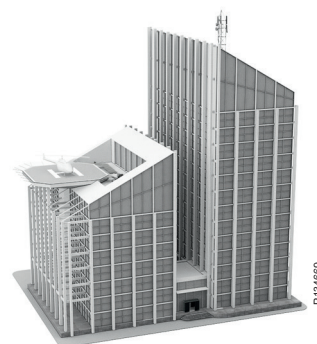

## C2 Pre-galvanized

Partly outdoor environments: Industries, sports halls, warehouses, shops, rural outdoor areas etc.

- Low environmental corrosion.
- Non-heated areas with fluctuating levels of temperature and humidity.
- Few instances of condensation and low levels of airborne pollution.
- SS-EN 10327:2004.

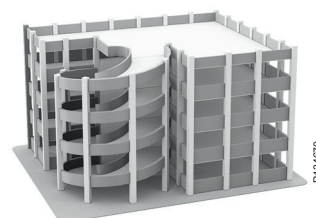

## C3 Hot-dip galvanized

Indoor- and outdoor environments: Urban and light industrial areas, breweries, dairies, laundries etc.

- Average environmental corrosion.
- Areas with average levels of humidity and some airborne pollution caused by production processes.
- Atmospheres containing some salt or average levels of airborne pollution.
- EN-ISO1461:2009

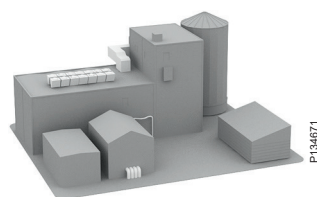



## C4 Hot-dip galvanized

Indoor- and outdoor environments: Chemical plants, industrial and coastal areas, swimming pools, farms, dockyards etc.

- High environmental corrosion.
- Areas with high levels of humidity and considerable airborne pollution.
- Atmospheres with average salt content or discernible levels of airborne pollution.
- EN-ISO1461:2009.

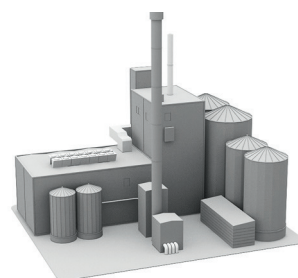

P134672

## C5-I Zinkpox® (Hot dip galv. + powder coated) Stainless steel AISI 304

Indoor- and outdoor environments: Chemical and heavy industries, tunnels, swimming pools, dockyards etc.

- Very high (industrial) environmental corrosion.
- Areas with almost permanent condensation, large quantities of airborne pollution, high levels of humidity and aggressive atmospheres
- SS2333 RF/AISI 304

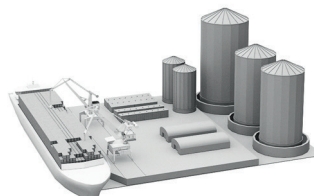

P134675

## C5-M Stainless steel, AISI 316L

Indoor- and outdoor environments: Heavy industries, coastal and offshore areas, purifying plants etc.

- Very high (marine) environmental corrosion.
- Areas with almost permanent condensation and large quantities of airborne pollution. Atmospheres with high salt content.
- SS2348 SF/AISI 316L

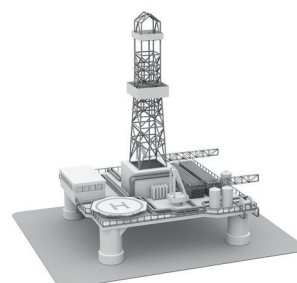

P134676

The life expectancy of a cable support system is dependent on the environment in which it is placed. Therefore, it is important to establish the corrosive properties of an environment to ensure that the right treatment and the right material are chosen. Do not use components finish above of the corrosion class targeted. The table below shows various corrosion classes. As a guide, we have included the surface treatment recommended by Schneider Electric for the different classes.

On the next page, we briefly outline the various surface treatments and materials.

As regards environmental corrosion, a steel design component can usually be assigned to one of the corrosion classes (C1 to C5-M) as shown in table A. Reference values for the average level of corrosion in steel and zinc are given in table B. The corrosion classes comply with those stipulated in SS-EN ISO 12944-2.

**Table A**

Corrosion classes as stipulated by SS-EN ISO 12944-2 with atmospheric corrosion levels and examples of the environment in which they are most suitable for use.

Corrosion class	Environmental corrosion	Examples of typical environments in temperate climates (informative)		Schneider Electric designation
		Outdoors	Indoors	
C1	Very low	–	Heated areas with arid atmosphere and insignificant quantities of pollutant, e.g. offices, shops, schools and hotels.	<b>Electro-galvanized</b> DIN 50961/ISO 2081
C2	Low	Atmospheres with low levels of airborne pollution. Rural areas.	Non-heated areas with fluctuating levels of temperature and humidity. Few instances of condensation and low levels of airborne pollution, e.g. sports halls and warehouses.	<b>Pre-galvanized</b> Z 275 in accordance with SS-EN 10327:2004
C3	Average	Atmospheres containing some salt or average levels of airborne pollution. Urban and light industrial areas. Areas affected by coastal conditions.	Areas with average levels of humidity and some airborne pollution resulting from production processes, e.g. breweries, dairies, laundries.	<b>Hot-dip galvanized</b> after manufacture in accordance with EN-ISO 1461:2009
C4	High	Atmospheres with average salt content or discernible levels of airborne pollution. Industrial and coastal areas.	Areas of high humidity and considerable airborne pollution as the result of production processes, e.g. chemical plants, swimming pools and dockyards.	
C5-I	Very high (industrial)	Industrial areas with high levels of humidity and aggressive atmospheres.	Areas with almost permanent condensation and large quantities of airborne pollution.	<b>Zinkpox®</b> HDG+powder coating
C5-M	Very high (marine)	Coastal and offshore areas with high salt content.	Areas with almost permanent condensation and large quantities of airborne pollution.	<b>Stainless steel</b> SS2333 AISI 304
				<b>Stainless steel</b> SS2348 AISI 316L

Zinc+ coating  
Thermoplastic coating\*

\* Only for Wibe Cable ladders

**Table B**

Mass losses for steel and zinc in various corrosion classes

Corrosion class	Mass loss per surface unit and thickness reduction (1 year of exposure) <sup>1</sup>			
	Steel		Zinc	
	Mass loss (g/m <sup>2</sup> )	Thickness reduction (µm)	Mass loss (g/m <sup>2</sup> )	Thickness reduction (µm)
C1	≤ 10	≤ 1.3	≤ 0.7	≤ 0.1
C2	> 10 to 200	> 1.3 to 25	> 0.7 to 5	> 0.1 to 0.7
C3	> 200 to 400	> 25 to 50	> 5 to 15	> 0.7 to 2.1
C4	> 400 to 650	> 50 to 80	> 15 to 30	> 2.1 to 4.2
C5-I	> 650 to 1500	> 80 to 200	> 30 to 60	> 4.2 to 8.4
C5-M	> 650 to 1500	> 80 to 200	> 30 to 60	> 4.2 to 8.4

<sup>1</sup> Corrosion speed is generally higher when the material is first exposed



**Wibe Cable Trays – Technical and material data**

Specification:	Cold formed steels: DX5xD acc. to EN 10346, DC0x acc. to EN 10130, DD1x acc. to EN10111 Structural steels: S235 and S355 acc. to EN 10025-2 AISI 316L acc. to EN ISO10088-2
Density:	7.7-7.85 kg/m <sup>3</sup>
Surface treatment:	<ul style="list-style-type: none"> <li>• Pre-galvanized (&gt;20 µm): EN 10346</li> <li>• Pre-galvanized (&gt;20 µm), powder coated white NCS S 0500-N</li> <li>• Hot-dip galvanized (55-70 µm): EN ISO 1461</li> <li>• Zinkpox, hot-dip galvanized (55-70 µm) + polyester coating, white RAL 9010</li> <li>• Passivated (Stainless steel)</li> </ul>
Resistance to impact	20 J (IEC 61537)
Temperature range	From -40°C to +120°C

**Electro-galvanized**

Products are manufactured in accordance with DIN 50961/ISO 2081. Such products are intended for use only in warm, dry areas with negligible pollutant levels.

**Pre-galvanized**

Products are manufactured from Z 275 pre-galvanized sheet steel in accordance with SS-EN 10327:2004. Under normal conditions, surface sections created during cutting and drilling will repair themselves, providing superb anti-corrosion protection.

**Hot-dip galvanized**

Schneider Electric has one of the most modern hot-dip galvanization plants in the Nordic countries. The hot-dip process is continuous, guaranteeing a high and even quality. The manufactured products are hot-dip galvanized in accordance with EN-ISO 1461:2009 whilst nuts and bolts are hot-dip galvanized in accordance with SS-EN ISO 10684:2004. This form of galvanization affords very good value-for-money anti-corrosion protection in atmospheres with a pH value of between 6 and 13. However, in acidic environments where pH levels fall below 6 and in alkaline environments where the pH value exceeds 13, the protective zinc layer breaks down relatively quickly.

When cuts/perforations or other kind of operation that damage or remove coating in HDG items suitable to be installed in aggressive corrosion class, must be repaired with a zinc rich paint.

**Zinc+**

Zinc+ surface treatment for some accessories (EN 10346) with a metallic Zinc-based alloy coating containing Aluminium and Magnesium that offers ultimate corrosion resistance in aggressive environments (e.g. chloride & highly alkaline). In many cases a good alternative to hot-dip galvanization. Excellent surface finish with self-repairing protection of cut edges (galvanic protection).

**Zinkpox®**

The Zinkpox® method involves applying a homogenous polyester coating to the zinc layer. Besides resisting light-initiated degeneration and weathering, this powder coating has excellent mechanical properties as regards impact resistance and adhesion. It is also resistant to most chemicals. Compared to hot-dip galvanizing, applying a polyester coating to the zinc layer more than doubles the service life of treated components. The zinc layer prevents the development of filiform corrosion. This might otherwise degrade the coating. Consequently, the polyester coating is subject only to atmospheric attack and thus protects the zinc layer. The certified coating plant that treats our components uses a modern and environment-friendly process. Before powder coating, the galvanized components undergo meticulous pre-treatment. This ensures superb adhesion. In addition to extremely good corrosion protection, the Zinkpox® method also offers a choice of colours. Powder coating is a very environment-friendly way of achieving a coloured surface. Because the coating contains no solvents, it has largely replaced solventbased liquid coatings. Where installations are visible, cable trays and fittings can be finished in a coating that matches the surrounding décor.

**Thermoplastic coating**

An option for corrosive environments. Thermoplastic coating is a thermal process in which a plastic powder is melted to give the component (most usually metal) a special coat. Thermoplastics are predominantly employed in aggressive environments up to and including corrosion class C5-M (ISO 12944-6), where they provide hardwearing, long-lasting and environment-friendly protection against, among other things, corrosion. Because the coa-

ting process is thermal with no solvents, it has minimal impact on the environment. Thermoplastic coatings meet the requirements

of the most aggressive environments, e.g. wet, humid environments and those with large temperature variations and concentrations of chemicals. Besides durability, the coatings also have high impact resistance. As the coating provides complete cover, is pore-free and strong, it is also hygienic and dirt repellent. V0 fire rating (UL94), UV resistant.

**Stainless steel**

Products manufactured in accordance with SS 2333/AISI 304 or SS 2348/AISI 316L are designed for use in highly aggressive environments, either indoors or outdoors, on industrial sites where there are high levels of potent airborne pollution such as in certain chemical industries, cellulose-related industries, refineries or artificial fertilizer factories, high humidity tunnels, etc. Stainless steel products are also ideal for use in environments where special hygiene requirements are in force, such as dairies, abattoirs, other food industries and pharmaceutical factories.

**Stainless steel AISI 304 or AISI 316L**

The deciding factor in choosing between stainless steel AISI 304 or AISI 316L is the aggressiveness of the environment in which it is to be used, and for this atmospheric chlorine content plays a significant role. Environments with a high chlorine content, coastal areas being a prime example, are aggressive and usually require the use of AISI 316L materials. When assessing the needs of factories, consideration should be given to the materials previously used to suspend equipment such as pipe tubing, and from this determine whether stainless steel AISI 304 or AISI 316L material is required.

**To consider when installing Stainless Steel Cable Trays**

- 1. Transport/handling:** Make sure that no iron objects come into contact with the stainless steel products.
- 2. Storing:** Never store stainless steel products close to where iron products are machined, for example close to cutting and grinding operations
- 3. Welding:** Welding during installation should be avoided where possible. If welding must be performed, make sure that only methods suitable for stainless steel are used.
- 4. Tools:** When cutting or grinding, always use cutting wheels and grinding tools which are free from iron. Do not use tools that have been previously used for cutting or grinding products containing iron. When drilling, use an HSS-drill. To maximize the useful life of the drill, employ a cooling fluid during drilling. When installing, conventional assembly tools can be used. However, when using a nut tightener, ensure that the thread is first lubricated to prevent jamming.  
*Never mix untreated or galvanized products with stainless steel.*
- 5. Measures:** If a blue annealing appears when cutting, grinding or drilling, re-move it with pickling paste, making sure that the paste is then carefully washed away with water. If selective corrosion appears it can be removed by:
  - a) Washing away with water (high-pressure if possible).
  - b) Polishing with a cleaning cloth or a fine emery paper (wet or dry) and washing with water.
  - c) Grinding with a fine-grained wheel and washing with water.
  - d) Pickling with pickling paste, making sure that the pickling paste is then carefully washed away with water.
- 6.** When using pickling paste or similar products, always study the safety code for the product prior to use.

### Electrical continuity and earthing

The standard EN 61537 establishes that for cable trays with electrical continuity characteristics (metal), this continuity should be guaranteed by means of an equipotential connection and one or several connections to earth in accordance with the use of the tray system.

The impedance must not exceed:  
 - 50 mΩ through the joint.  
 - 5 mΩ x metre of cable trays. (\*)

(\*) Currently this value is studied through document IEC/SC23A/WG12, CLC/TC213/WG-5 – 765. It will be changed to 50 mΩ x metre.

The metre length and joining systems for the different sections that Schneider Electric has, as well as the joints of the different accessories supplied, comply with the electrical continuity test established in the aforementioned standard, guaranteeing the impedance

established. To guarantee these impedance values tightening torque values of no less than 5 Nm are recommended, always using the joints recommended for each tray type, and taking sizes into account. Ensure that all connections are well fixed and proper values are matching according to local legislation

To guarantee a safe installation, Schneider Electric recommends a proper earthing of all the elements that make up the system (sections and accessories), using the accessories designed specifically for this purpose.

**SCHNEIDER ELECTRIC RECOMMENDS NOT TO USE THE TRAY AS EARTH OR NEUTRAL CONDUCTORS. SCHNEIDER ELECTRIC IS NOT RESPONSIBLE OF ANY DAMAGE IF YOU USE ACCESSORIES FROM OTHER MANUFACTURERS.**

### Cable trays

Installed with Screw set W38P  
 Tightening torque 2 Nm

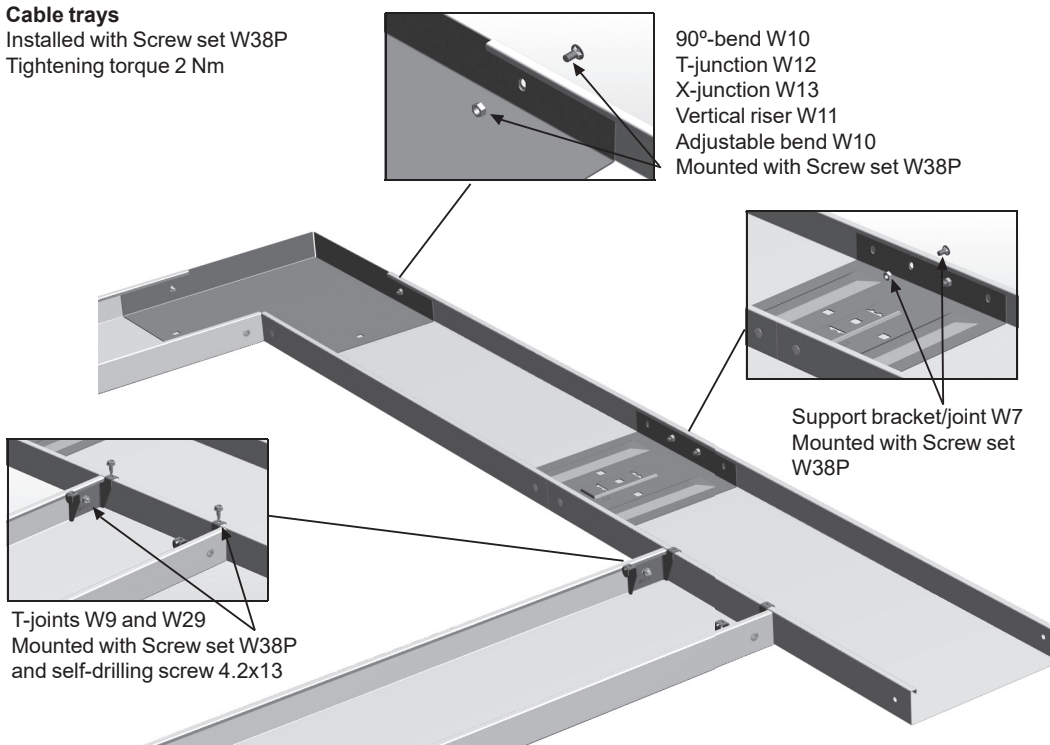

Product	Ohm/m
Cable Tray W1-200, white, with Joint W7, white + Screw set W38P, white	0,0026
Cable Tray W1-200, pre-galv, with Joint W7, pre-galv + Screw set W38P	0,00114
Cable Tray W1-200, pre-galv, with Joint W7, pre-galv + blind rivet	0,00118
Cable Tray W1-200, white, with Joint W7, pre-galv + Screw set W38P, white	0,003
Cable Tray W1-200, white, with Joint W7, pre-galv + blind rivet. (Paint taken away at the blind rivet)	0,00370



## Electromagnetic Compatibility

Schneider Electric has performed measurements at EMC Services in Gothenburg regarding EMC requirements, report RE-10273-17181. The results show that the shielding performance of both incoming and emitted fields is good concerning Wibe cable trays.

When correctly installed Wibe cable trays products work as a protective earth structure. This means that Schneider Electric products can be used to achieve good engineering practice in accordance with the EMC directive 2004/108/EG.

### Recommended installation examples

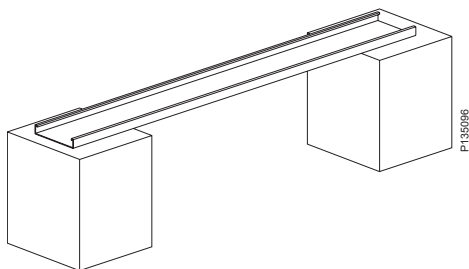

Metal against metal connection  
- the ultimate installation

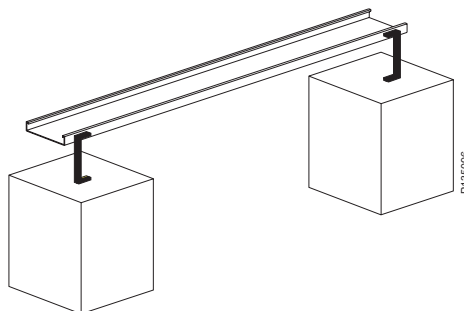

Short double connection  
- realistic installation

### Not recommended installation examples

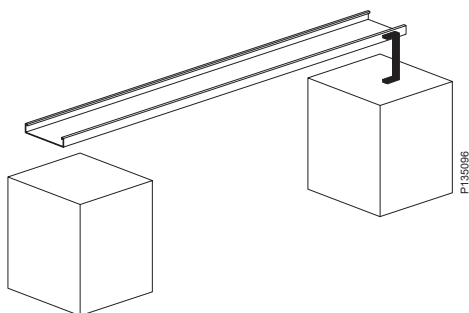

Single connection  
- poor installation

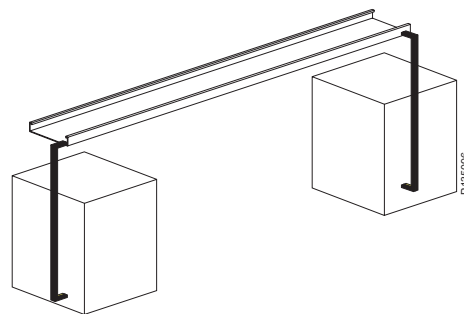

Long double connection  
- in best case EMC neutral

## Minimum separation distance (mm), figure A

Recommended cable management

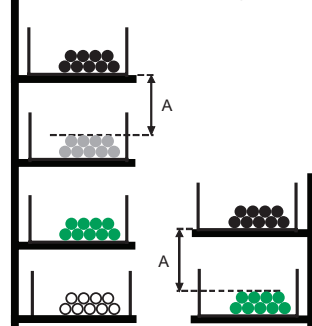

Recommended cable management on common cable tray

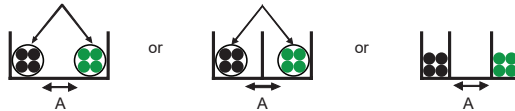

The cables should be fixed to the tray or bundled

- Power cables
- Data cables
- Control cables
- Sensitive cables like instrumentation cables
- A Separation distance

No fixing or bundling needed.

## Installation of cable tray

Full design data is given according to EN 61537 in the Range part in this catalogue showing all maximum and recommended loadings. Graphs are given in this catalogue to show the deflection against loading for various support distances. Any support system which is supported at intervals and loaded will deflect between the support intervals. Test model type 1 is used for all cable tray ranges.

## Installation recommendations for cable trays

The cable trays should be installed in such a way that, as often as possible, the cables can be laid directly in place rather than being pulled through. Trays for current carrying cables along the ceiling should be installed in such a way that the distance from the top of the tray to the ceiling is not less than 300 mm. The free vertical distance between parallel trays shall be at least 200 mm. Trays near walls should be installed with a minimum free distance of 50 mm to the wall, so that cables can pass between the trays and the wall. Trays along partition walls should be installed with a minimum free distance of 100 mm to the wall. Sharp edges and screw ends on trays should be removed before the cables can be installed. Expansion bolts for the installation of brackets/fixings should be installed with such a distance between them, that the designated load for trays will not be exceeded. When selecting the distance between cantilever arms or brackets/fixings, the bearing strength and designated load of the trays must be taken into consideration.



**Wibe Cable tray system meets the following standards:**

IEC 61537  
NEMA VE 1/CSA 22.2

Tests and Certificates	Test made by
Wibe cable tray as conductor of equipotential bonding according to IEC 61537, 11:1.	SP, Sweden
Wibe cable tray is tested according to Underwriters Laboratories, UL E-80034.	UL, USA & Canada
Wibe cable tray is approved by Det Norske Veritas (DNV) for offshore and ship-yard use.	DNV, Norway
Wibe cable tray is approved by Russian Maritime Register of Shipping, RS type approval certificate 10.02103.011.	Russian Maritime Register of Shipping, Russia

**Management system - Quality and Environment**

Schneider Electric has a third-party certified management system for quality and environment in accordance with ISO 9001:2008 and ISO 14001:2004.

**CE-marking of products**

The CE-marking of products is placed on the product or on the packing according to "Declaration of Conformity" (DOC), applicable to Schneider Electric Cable Support System.

**EMC directive 89/336 EEC**

The Cable Support System is neutral according to the EMC directive 89/336 EEC.

**Low voltage directive 73/23 EEC**

According to the low voltage directive we refer to: SFS 1993:1068 Regulations concerning electrical material.

SFS 1993:1068 General obligations regarding electrical material.

Schneider Electric fulfills the demands according to the harmonized standard SS-EN 6153 Edition 1:2002.

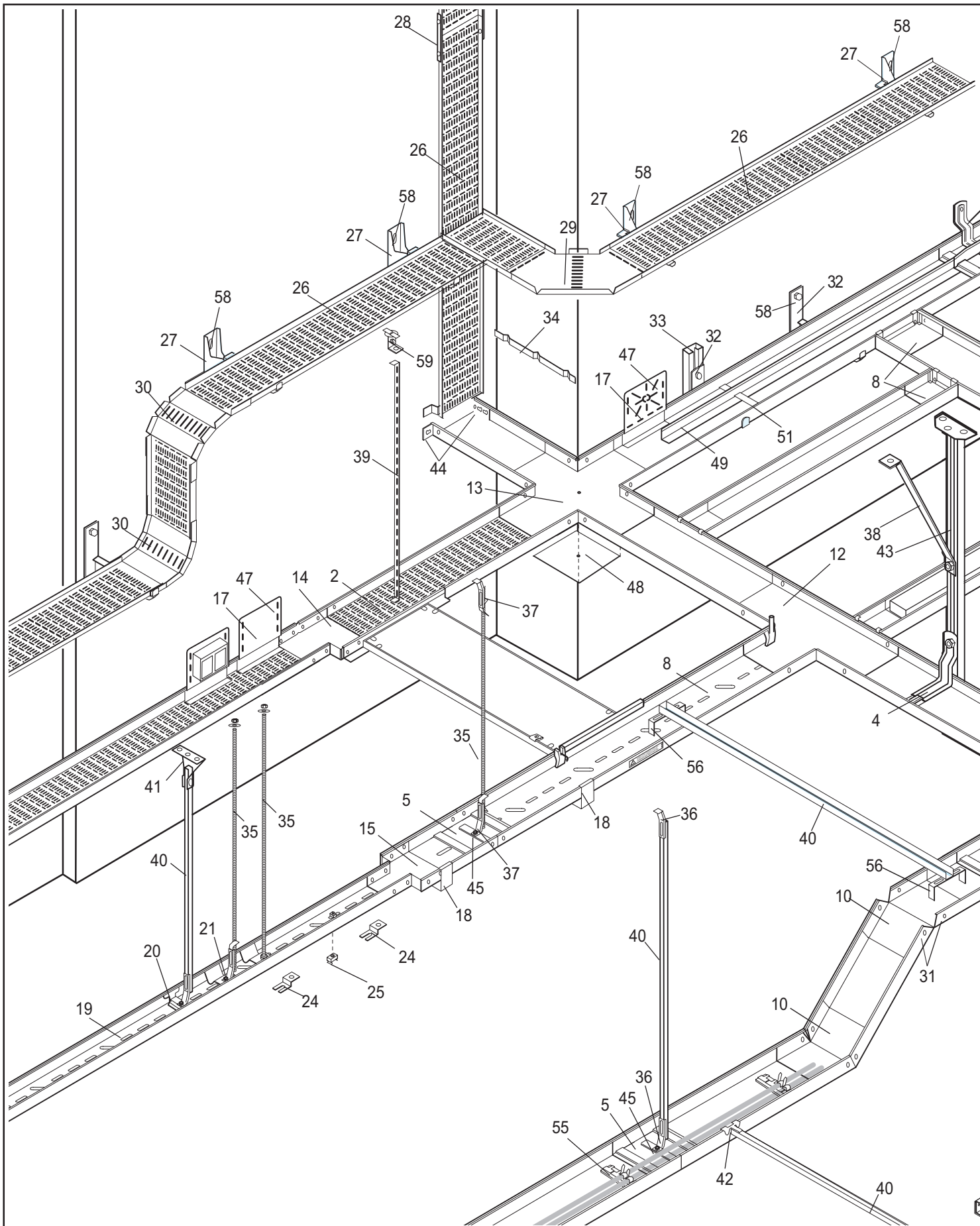

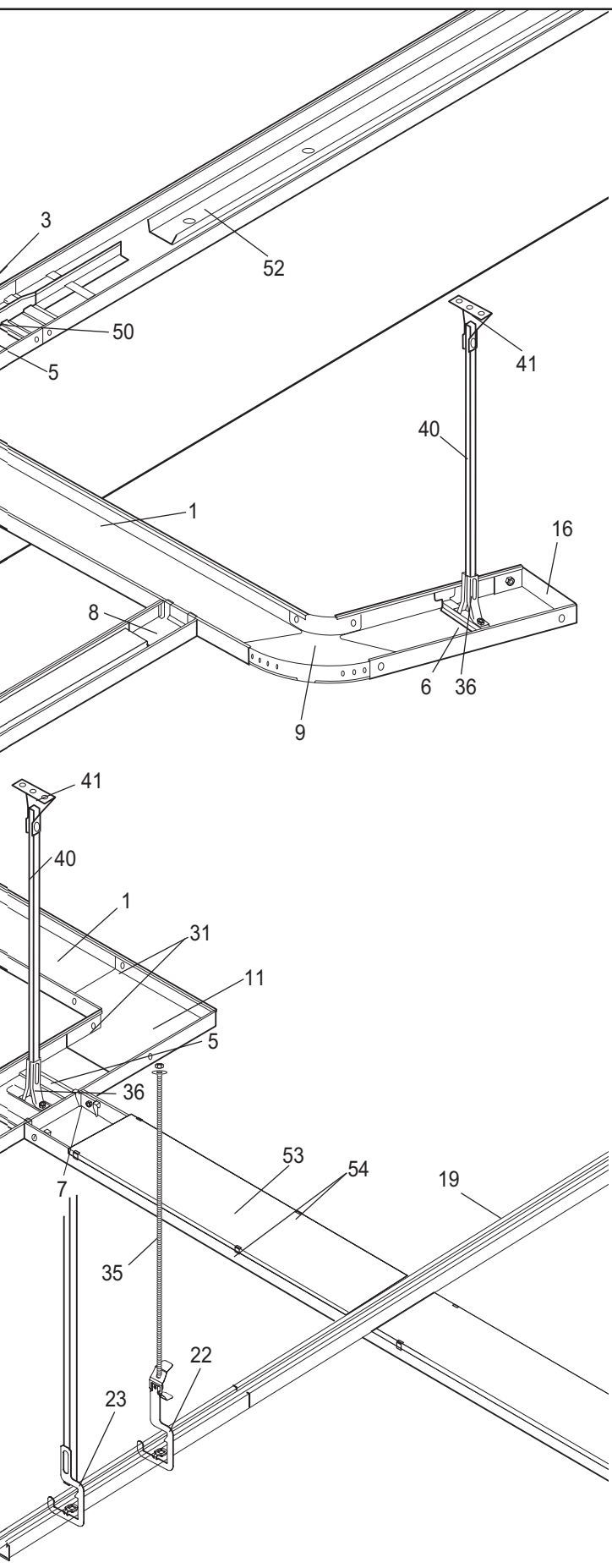

## Components

- 1 Cable tray W1/40
- 2 Cable tray W3/40  
Cable tray system W1/60, W3/60 209-231
- 3 Internal cantilever arm W17/40167
- 4 Adjustable cantilever arm W1840 168
- 5 Support bracket/joint W7/40
- 6 Support bracket W1940
- 7 T-joint W9/40
- 8 T-joint W29/40
- 9 Adjustable bend W10/40
- 10 Vertical riser W11/40
- 11 90° bend W10/40
- 12 T-junction W12/40
- 13 X-junction W13/40
- 14 Reducer W28
- 15 Reducer W28
- 16 End cover W45/40
- 17 Junction box plate W24/40
- 18 Luminaire bracket W25/40
- 19 Lighting trunking W70
- 20 Support bracket W20
- 21 Support bracket W20A
- 22 Pendant bracket W80
- 23 Pendant bracket W81
- 24 Luminaire bracket W35
- 25 Luminaire bracket W55
- 26 Installation tray W4
- 27 Cantilever arm 50i, 81
- 28 Joint W2
- 29 90° bend W4
- 30 Vertical riser W4
- 31 Screw set W38P
- 32 Cantilever arm 50
- 33 Mounting rail 40
- 34 Mounting rail WMS15, WMS25
- 35 Threaded rod W76 M6, M8, M10
- 36 Pendant attachment W21
- 37 Tube pendant attachment W73
- 38 Pendant bar 1
- 39 Pendant strip W33
- 40 Pendant rail W32
- 41 Ceiling attachment W31
- 42 Locking clamp W77
- 43 Vertical piece 2F
- 44 Angle bracket W8
- 45 Screw set W36/W36C
- 47 Earth clamp W79
- 48 Cover plate W16
- 49 Dividing strip 39
- 50 Insert piece W39
- 51 Support band W6
- 52 Tele-conduit 36
- 53 Cover W5
- 54 Cover clamp W62
- 55 Strip fixing W44
- 56 Luminaire bracket W50
- 58 Expansion bolts
- 59 Fixings-Ogebe



# Suspension components

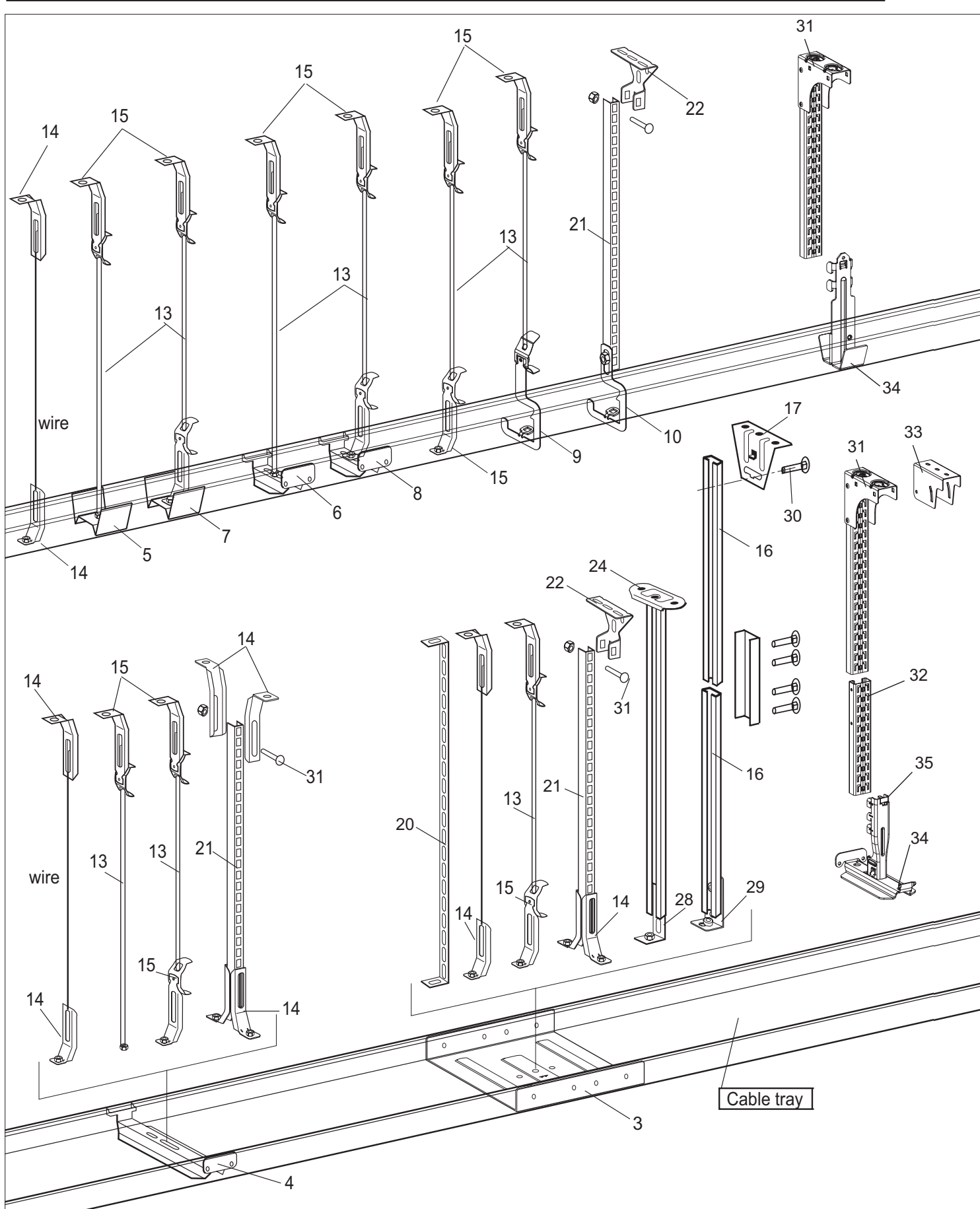

## Wibe cable trays

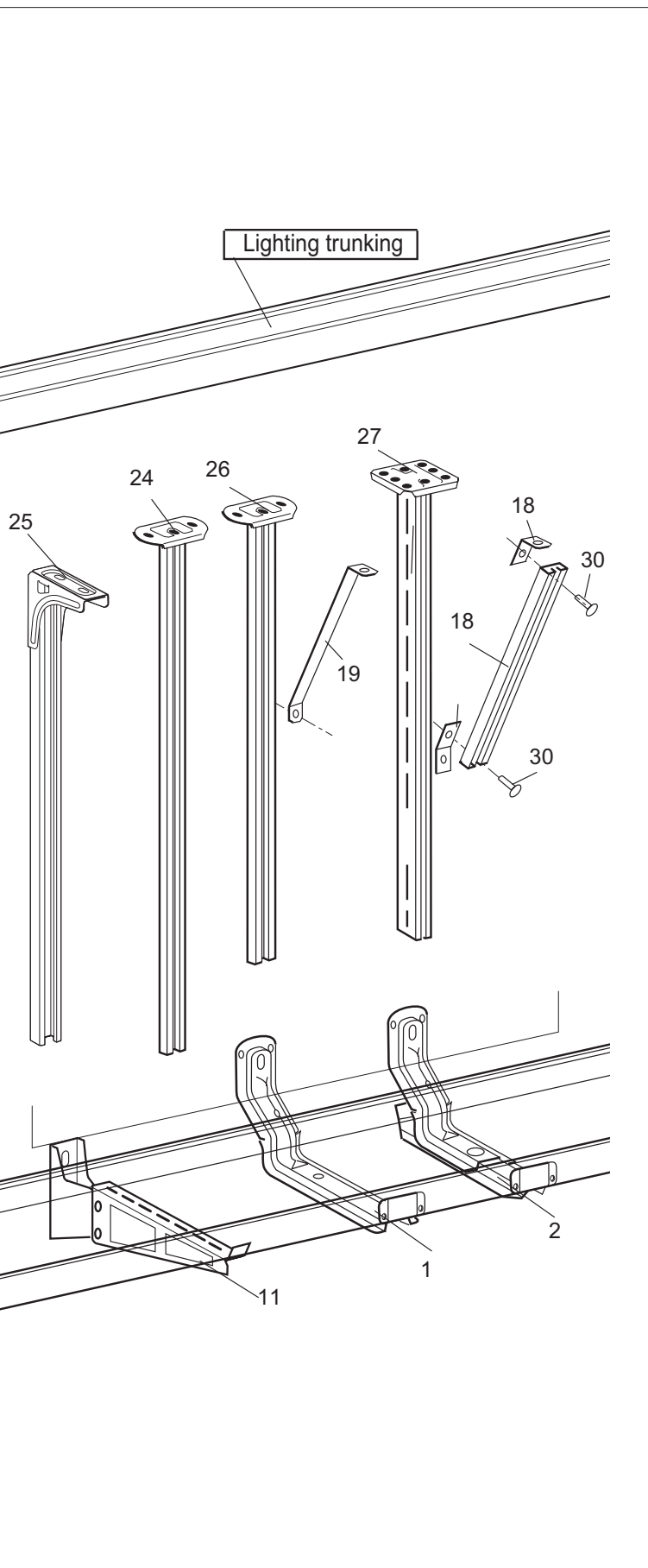

### Components

- 1 Internal cantilever arm W17/40
- 2 Adjustable cantilever arm W1840
- 3 Support bracket/joint W7/40
- 4 Support bracket W1940
- 5 Support bracket W20-70
- 6 Support bracket W20-100
- 7 Support bracket W20A-70
- 8 Support bracket W20A-100
- 9 Pendant bracket W80
- 10 Pendant bracket W81
- 11 Cantilever arm 50i
- 13 Threaded rod W76 M6, M8, M10
- 14 Pendant attachment W21
- 15 Tube pendant attachment W73
- 16 Pendant/Fixing rail 24/34
- 17 Ceiling bracket 5
- 18 Bracket 60/40
- 19 Pendant bar 1
- 20 Pendant strip W33
- 21 Pendant rail W32
- 22 Ceiling attachment W31
- 24 Vertical piece 2
- 25 Vertical piece 2Fi
- 26 Vertical piece 2F
- 27 Vertical piece 20
- 28 Angle bracket W8
- 29 Angle bracket W8S
- 30 Screw set 22Sa
- 31 CLX<sup>3</sup> Pendant 24/48
- 32 CLX<sup>3</sup> Rail 24/48
- 33 CLX<sup>3</sup> Adjustable ceiling plate
- 34 CLX<sup>3</sup> Central suspension bracket, cable tray H40
- 35 CLX<sup>3</sup> Central suspension adater

### Cable trays, unperforated

Type	Dimensions A/B/C mm	 Weight kg/100 m	EAN code	Ref. No.
------	------------------------	--	----------	----------

#### Cable tray W1

Unperforated cable tray for indoor applications in dry environments. System height 40 mm. Provided with holes Ø 5.8 mm at the tray end to be used for fixation of joints.

Material: Steel, pre-galvanized.

W1/40-70	40/70/2000	95	7321677132515	<b>713251</b>
	40/70/3000	95	7321677208227	<b>720822</b>
W1/40-100	40/100/2000	115	7321677132522	<b>713252</b>
	40/100/3000	115	7321677209842	<b>720984</b>
W1/40-200	40/200/2000	170	7321677132546	<b>713254</b>
	40/200/3000	170	7321677209859	<b>720985</b>
W1/40-300	40/300/2000	400	7321677132560	<b>713256</b>
	40/300/3000	400	7321677266647	<b>726664</b>
W1/40-400	40/400/2000	500	7321677132577	<b>713257</b>
	40/400/3000	500	7321677266654	<b>726665</b>
W1/40-500	40/500/2000	710	7321677132584	<b>713258</b>
	40/500/3000	710	7321677266661	<b>726666</b>
W1/40-600	40/600/2000	825	7321677232192	<b>723219</b>
	40/600/3000	825	7321677266678	<b>726667</b>
W1/40-500 FS	40/500/2000	715	7321677868315	<b>786831</b>
W1/40-600 FS	40/600/2000	830	7321677868322	<b>786832</b>

Unperforated cable tray for indoor applications in dry environments. System height 60 mm. Provided with holes Ø5.8 mm at the tray end to be used for fixation of joints.

Material: Steel, pre-galvanized.

W1/60-70	60/70/2000	165	7321677819997	<b>781999</b>
W1/60-100	60/100/2000	185	7321677820009	<b>782000</b>
W1/60-200	60/200/2000	335	7321677820016	<b>782001</b>
W1/60-300	60/300/2000	440	7321677239740	<b>723974</b>
W1/60-400	60/400/2000	540	7321677239757	<b>723975</b>
W1/60-500	60/500/2000	755	7321677239764	<b>723976</b>
W1/60-600	60/600/2000	870	7321677239771	<b>723977</b>
W1/60-500 FS	60/500/2000	760	7321677820467	<b>782046</b>
W1/60-600 FS	60/200/2000	875	7321677820474	<b>782047</b>

PTCSU-0002



PTCSU-0002





# Steel cable trays

Pre-galvanized  
Corrosion class C2

## Cable trays, perforated

Type	Dimensions A/B/C mm	Weight kg/100 m	EAN code	Ref. No.
------	------------------------	--------------------	----------	----------

### Cable tray W3

Perforated cable tray for indoor applications in dry environments. System height 40 mm. Provided with holes Ø 5.8 mm at the tray end to be used for fixation of joints. Oval holes along the lateral side of the tray can be used for mounting of accessories.  
Material: Steel, pre-galvanized.

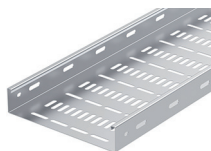

PTCSLU-0018

W3/40-50	40/50/3000	103	7321677353880	<b>735388</b>
W3/40-70	40/70/3000	120	7321677353897	<b>735389</b>
W3/40-100	40/100/3000	136	7321677353903	<b>735390</b>
W3/40-150	40/150/3000	170	7321677353910	<b>735391</b>
W3/40-200	40/200/3000	196	7321677353927	<b>735392</b>
W3/40-300	40/300/3000	316	7321677353934	<b>735393</b>
W3/40-400	40/400/3000	390	7321677353941	<b>735394</b>
W3/40-500	40/500/3000	590	7321677353958	<b>735395</b>
W3/40-600	40/600/3000	683	7321677353965	<b>735396</b>

Perforated cable tray for indoor applications in dry environments. System height 60 mm. Provided with holes Ø 5.8 mm at the tray end to be used for fixation of joints. Oval holes along the lateral side of the tray can be used for mounting of accessories.  
Material: Sheet steel, pre-galvanized.



PTCSLU-0018

W3/60-70	60/70/3000	150	7321677822027	<b>782202</b>
W3/60-100	60/100/3000	180	7321677822034	<b>782203</b>
W3/60-150	60/150/3000	200	7321677822041	<b>782204</b>
W3/60-200	60/200/3000	240	7321677822058	<b>782205</b>
W3/60-300	60/300/3000	337	7321677822065	<b>782206</b>
W3/60-400	60/400/3000	440	7321677822072	<b>782207</b>

### Installation tray W4

Perforated installation tray for indoor applications in dry environments. To be used when leading cables down from a cable ladder to machine cabinets, etc. Provided with holes Ø 3.5 mm in the bottom segment of the tray for the clamping of cables with plate screws.



ODAV36992-bis

W4-50	15/50/1960	57	7321677366033	<b>736603</b>
	15/50/3000	57	7321677359882	<b>735988</b>
W4-75	15/75/1960	76	7321677366040	<b>736604</b>
	15/75/3000	76	7321677359899	<b>735989</b>
W4-100	15/100/1960	93	7321677366057	<b>736605</b>
	15/100/3000	93	7321677359905	<b>735990</b>
W4-150	15/150/1960	125	7321677366064	<b>736606</b>
	15/150/3000	125	7321677359912	<b>735991</b>
W4-200	15/200/1960	195	7321677366071	<b>736607</b>
	15/200/3000	195	7321677359929	<b>735992</b>
W4-250	15/250/1960	228	7321677366088	<b>736608</b>
	15/250/3000	228	7321677359936	<b>735993</b>
W4-300	15/300/1960	238	7321677366095	<b>736609</b>
W4-400	15/400/1960	313	7321677366101	<b>736610</b>

### Lighting trunking

PTCSU-0019



Type	Dimensions A/B/C mm	Weight kg/100 m	EAN code	Ref. No.
<b>Lighting trunking W70-50, -70, -100, -200</b>				
Cable tray with bottom perforation for indoor applications in dry environments. System height 40 mm, length 3000 mm. Oval holes 9x5.8 mm on the lateral sides of the tray end can be used for fixation of joints. The oval hole pattern at the base of the tray can be used for mounting of lighting fixtures. On every 500 mm an oval hole is placed to easily guide fast connectors into the tray. Material: Steel, pre-galvanized.				
W70-50	40/50/3000	242	3606480756092	<b>CSU795216</b>
W70-70	40/70/3000	274	3606480410383	<b>CSU794123</b>
W70-100	40/100/3000	323	3606480410345	<b>CSU794124</b>
W70-200	40/200/3000	487	3606480410369	<b>CSU794125</b>



### Covers

P140357

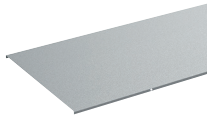

		Weight kg/100 pcs		
<b>Cover W5</b>				
Cover to be used to protect the cables inside the cable tray against damages, dust, liquids, UV-influence, etc. Material: Sheet steel, pre-galvanized.				
W5-70	10/71/2000	100	7321677322145	<b>732214</b>
W5-100	10/101/2000	140	7321677322152	<b>732215</b>
W5-150	10/151/2000	190	7321677322169	<b>732216</b>
W5-200	10/201/2000	250	7321677322176	<b>732217</b>
W5-300	10/301/2000	360	7321677322183	<b>732218</b>
W5-400	10/401/2000	680	7321677322190	<b>732219</b>
W5-500	10/501/2000	840	7321677322206	<b>732220</b>
W5-600	10/601/2000	700	7321677322213	<b>732221</b>

P146808



<b>Cover clamp W62</b>				
Cover clamp to be used for the fixing of covers on cable trays W1/W3 as well as on lighting trunking W70. Material: Stainless steel 304.				
W62	-/15/10.5	0.8	7321677301867	<b>730186</b>

### Dividers

P140356



<b>Dividing strip 39</b>				
Dividing strip to be used to separate power and data communication cables inside a W1/W3 cable tray or W70 lighting trunking. Mounted with Support band 6. Material: Steel, pre-galvanized.				
39/24	24/24/1760	46	7321677188352	<b>718835</b>
39/55	55/24/1750	73	7321677257850	<b>725785</b>

P140044



<b>Insert piece W39</b>				
Insert piece to be used to join Dividing strips 39/24 in cable tray W1/W3 and lighting trunking W70/71. The Insert piece can be positioned on Support bracket/joint W7/40 to ensure a continuous separation of cables inside the cable tray. Material: PP, natural coloured.				
W39	37-/330	3	7321677168248	<b>716824</b>

782299



<b>Insert piece W39/55</b>				
Insert piece to be used to join Dividing strips 39/55 in Cable trays W1/60 or W3/60. The insert piece can be positioned on Support bracket/joint W7/60 to ensure a continuous separation of cables inside the cable tray. Material: Sheet steel, pre-galvanized.				
W39/55	54/4.4/400	19	7321677822997	<b>782299</b>















### Dividers

PTCSU-0020

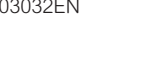

<b>Support band W6</b>				
Support band to be placed inside cable trays to fix the lateral position of one or several Dividing strips W39. The holes in the support band and the locking pins in Dividing strip W39 enable an adjustment of the lateral positioning of the dividing strip with an interval of 25 mm. Material: Sheet steel, pre-galvanized.				
W6-70	-/18/67	1.0	7321677188284	<b>718828</b>
W6-100	-/18/97	1.4	7321677188291	<b>718829</b>
W6-200	-/18/197	2.8	7321677188307	<b>718830</b>
W6-300	-/18/297	4.3	7321677188314	<b>718831</b>
W6-400	-/18/397	5.7	7321677188321	<b>718832</b>
W6-500	-/18/497	7.2	7321677188338	<b>718833</b>
W6-600	-/18/597	8.6	7321677188345	<b>718834</b>

### Joins

	Type	Dimensions A/B/C mm		Weight kg/100 pcs	EAN code	Ref. No.
<b>Support bracket/joint W7</b>						
To be used as a support bracket or joint for cable tray W1/40, W3/40 and for lighting trunking W70. When joining cable tray W1/40 FS (reinforced), side joint W49/40 must be used. Material: Sheet steel, pre-galvanized.						
782212		W7/40-50	38/48/200	14	7321677345540	<b>734554</b>
	40-50					
PTCSU-0006		W7/40-70	38/68/200	16	7321677208258	<b>720825</b>
	40-70, 100					
782212		W7/40-100	38/98/200	25	7321677170210	<b>717021</b>
	40-150					
PTCSU-0006		W7/40-150	38/148/200	35	7321677345557	<b>734555</b>
	40-200, 300, 400					
782212		W7/40-200	38/198/200	43	7321677170227	<b>717022</b>
	40-500, 600					
PTCSU-0006		W7/40-300	38/297/300	110	7321677170234	<b>717023</b>
	60-70, 100					
782212		W7/40-400	38/397/300	140	7321677170241	<b>717024</b>
	60-150					
PTCSU-0006		W7/40-500	38/498/300	170	7321677209903	<b>720990</b>
	60-200, 300, 400					
782212		W7/40-600	38/598/300	200	7321677231805	<b>723180</b>
	60-500, 600					
PTCSU-0006		W7/60-70	58/68/152	22	7321677822096	<b>782209</b>
	60-150					
782212		W7/60-100	58/98/200	33	7321677184453	<b>718445</b>
	60-200, 300, 400					
PTCSU-0006		W7/60-150	58/148/200	41	7321677822102	<b>782210</b>
	60-500, 600					
782212		W7/60-200	58/198/200	49	7321677184460	<b>718446</b>
	60-300					
PTCSU-0006		W7/60-300	58/297/300	122	7321677184477	<b>718447</b>
	60-400					
782212		W7/60-400	58/397/300	152	7321677184484	<b>718448</b>
	60-500					
PTCSU-0006		W7/60-500	58/498/300	180	7321677822119	<b>782211</b>
	60-600					
782212		W7/60-600	58/598/300	210	7321677822126	<b>782212</b>
<b>Side joint W49</b>						
Side joint to be used for straight joining of cable tray W1/40 and W3/40. Material: Sheet steel, pre-galvanized.						
PTCSU-0021		W49/40	37.5/-/300	17	7321677868353	<b>786837</b>
	W49/60		58/-/300	27	7321677822676	<b>782267</b>
<b>Flexible coupler W3-40</b>						
Side joint to be used for straight joining of cable tray W3/40 and can also be used to create T-junctions, X-junctions, reducers (left, right and straight), horizontal bends, vertical risers and direct mounting suspension strips. Material: Sheet steel, zinc+ treatment.						
PTCSU-0022		W3/40	36/2/300	12	3606480788987	<b>CSU795136</b>



### Joins

Type	Dimensions A/B/C mm		Weight kg/100 pcs	EAN code	Ref. No.
<b>Joint W2</b>					
Side joint to be used for straight joining of installation tray W4. Material: Sheet steel, pre-galvanized.					
W2	15/25/200		8	7321677885725	<b>788572</b>
<b>T-joint W9</b>					
T-joint to be used to construct T-sections or X-sections. Also used for oblique branches. The ref. number includes two pieces of T-joints and Screw set W38P. Material: Sheet steel, pre-galvanized.					
W9/40	40/72.5/20		6	7321677182053	<b>718205</b>
W9/60	60/72.5/20		5	7321677822171	<b>782217</b>
<b>T-joint W29</b>					
T-joint to be used to construct T-junctions or X-junctions. Easy push-in assembly. Locks into the tray via locking flap. To be suspended over the lateral side of the tray and locked in a suitable way. Material: Sheet steel, pre-galvanized.					
W29/40-70	38/67/68		8	7321677909841	<b>790984</b>
W29/40-100	38/67/98		12	7321677909858	<b>790985</b>
W29/40-200	38/67/198		21	7321677909865	<b>790986</b>
W29/40-300	38/67/301		30	7321677909872	<b>790987</b>
W29/40-400	38/67/401		40	7321677909889	<b>790988</b>
W29/40-500	38/67/501		50	7321677909896	<b>790989</b>
W29/40-600	38/67/601		59	7321677909902	<b>790990</b>
<b>T-joint W29</b>					
T-joint to be used to construct T-junctions or X-junctions. Easy push-in assembly. Locks into the tray via locking flap. To be suspended over the lateral side of the tray and locked in a suitable way. Material: Sheet steel, pre-galvanized.					
W29/60-70	58/67/68		22	7321677831784	<b>783178</b>
W29/60-100	58/67/98		27	7321677831791	<b>783179</b>
W29/60-200	58/67/198		37	7321677831807	<b>783180</b>
W29/60-300	58/67/298		47	7321677831814	<b>783181</b>
W29/60-400	58/67/398		57	7321677831821	<b>783182</b>
W29/60-500	58/67/498		67	7321677831838	<b>783183</b>
W29/60-600	58/67/598		77	7321677831845	<b>783184</b>

PTCSL-0023



718205



782217



790986



783180



### Bends

Type	Dimensions A/B/C mm		Weight kg/100 pcs	EAN code	Ref. No.
<b>90° bend W10</b>					
Horizontal 90° bend to be used for cable trays W1/40 and W3/40. Push-in assembly. Material: Sheet steel, pre-galvanized.					
W10/40-50 (flat)	38/183/183		14.9	3606480994937	<b>CSU795379</b>
W10/40-70	38/167/167		38	7321677179039	<b>717903</b>
W10/40-100	38/197/197		51	7321677179046	<b>717904</b>
W10/40-150	38/247/247		75	7321677334803	<b>733480</b>
W10/40-200	38/297/297		108	7321677179053	<b>717905</b>
W10/40-300	38/397/397		185	7321677179060	<b>717906</b>
W10/40-400	38/497/497		281	7321677179077	<b>717907</b>
W10/40-500	38/597/597		400	7321677211845	<b>721184</b>
W10/40-600	38/697/697		540	7321677231966	<b>723196</b>
Horizontal 90° bend to be used for cable trays W1/60 and W3/60. Push-in assembly. Material: Sheet steel, pre-galvanized.					
W10/60-70	58/167/167		43	7321677820382	<b>782038</b>
W10/60-100	58/197/197		55	7321677820399	<b>782039</b>
W10/60-150	58/247/247		85	7321677820405	<b>782040</b>
W10/60-200	58/297/297		117	7321677820412	<b>782041</b>
W10/60-300	58/397/397		196	7321677820429	<b>782042</b>
W10/60-400	58/497/497		295	7321677820436	<b>782043</b>
W10/60-500	58/597/597		413	7321677820443	<b>782044</b>
W10/60-600	58/697/697		551	7321677820450	<b>782045</b>
W10/60-500 FS	58/597/597		343	7321677824588	<b>782458</b>
W10/60-600 FS	58/697/697		465	7321677824595	<b>782459</b>
<b>Adjustable bend W10S</b>					
Adjustable bend to be used for horizontal angling from 105° to 165° in steps of 7.5°. Push-in assembly. Material: Sheet steel, pre-galvanized.					
W10S/40-50	38/47/47		9	7321677345847	<b>734584</b>
W10S/40-70	38/67/67		10	7321677168330	<b>716833</b>
W10S/40-100	38/97/97		13	7321677168347	<b>716834</b>
W10S/40-150	38/147/147		24	7321677345854	<b>734585</b>
W10S/40-200	38/197/197		40	7321677168354	<b>716835</b>
W10S/40-300	38/297/297		75	7321677168361	<b>716836</b>
W10S/40-400	38/397/397		125	7321677168378	<b>716837</b>
W10S/40-500	38/497/497		270	7321677249657	<b>724965</b>
W10S/40-600	38/597/597		380	7321677249664	<b>724966</b>
Adjustable bend to be used for horizontal angling from 105° to 165° in steps of 7.5°. Push-in assembly. Material: Sheet steel, pre-galvanized.					
W10S/60-70	58/67/67		17	7321677822683	<b>782268</b>
W10S/60-100	58/97/97		23	7321677822690	<b>782269</b>
W10S/60-150	58/147/147		37	7321677822706	<b>782270</b>
W10S/60-200	58/197/197		53	7321677822713	<b>782271</b>
W10S/60-300	58/297/297		97	7321677822720	<b>782272</b>
W10S/60-400	58/397/397		156	7321677822737	<b>782273</b>
W10S/60-500	58/497/497		292	7321677822744	<b>782274</b>
W10S/60-600	58/597/597		406	7321677822751	<b>782275</b>
<b>90° bend W4</b>					
Horizontal 90° bend to be used for cable tray W4. To be mounted on the outside of the tray and attached in the bottom segment with screw set W34. Material: Sheet steel, pre-galvanized.					
W4-50	16/52/-		10	7321677840731	<b>784073</b>
W4-75	16/77/-		15	7321677840748	<b>784074</b>
W4-100	16/102/-		22	7321677840755	<b>784075</b>
W4-150	16/152/-		37	7321677840762	<b>784076</b>
W4-200	16/202/-		55	7321677840779	<b>784077</b>
W4-250	16/252/-		77	7321677840786	<b>784078</b>
W4-300	16/302/-		102	7321677840793	<b>784079</b>
W4-400	16/402/-		161	7321677840809	<b>784080</b>

### Junctions

Type	Dimensions A/B/C mm		Weight kg/100 pcs	EAN code	Ref. No.
<b>T-junction W12</b>					
T-junction to be used for 90° horizontal junction of cable trays W1/40 and W3/40. Push-in assembly. Material: Sheet steel, pre-galvanized.					
W12/40-50 (flat)	-/185/248		19.6	3606480994975	<b>CSU795383</b>
W12/40-70	38/267/167		49	7321677179084	<b>717908</b>
W12/40-100	38/297/197		64	7321677179091	<b>717909</b>
W12/40-150	38/347/247		92	7321677334858	<b>733485</b>
W12/40-200	38/397/297		128	7321677179107	<b>717910</b>
W12/40-300	38/497/397		212	7321677179114	<b>717911</b>
W12/40-400	38/597/497		314	7321677179121	<b>717912</b>
W12/40-500	38/697/597		438	7321677211869	<b>721186</b>
W12/40-600	38/797/697		580	7321677231980	<b>723198</b>
<b>T-junction to be used for 90° horizontal junction of cable trays W1/60 and W3/60. Push-in assembly. Material: Sheet steel, pre-galvanized.</b>					
W12/60-70	58/267/167		54	7321677820528	<b>782052</b>
W12/60-100	58/297/197		70	7321677820535	<b>782053</b>
W12/60-150	58/347/247		99	7321677820542	<b>782054</b>
W12/60-200	58/397/297		133	7321677820559	<b>782055</b>
W12/60-300	58/497/397		217	7321677820566	<b>782056</b>
W12/60-400	58/597/497		320	7321677820573	<b>782057</b>
W12/60-500	58/697/597		443	7321677820580	<b>782058</b>
W12/60-600	58/797/697		585	7321677820597	<b>782059</b>
W12/60-500 FS	58/697/597		337	7321677824601	<b>782460</b>
W12/60-600 FS	58/797/697		454	7321677824618	<b>782461</b>
<b>X-junction W13</b>					
X-junction to be used for 90° horizontal junction of cable trays W1/40 and W3/40. Push-in assembly. Material: Sheet steel, pre-galvanized.					
W13/40-50 (flat)	-/248/248		23.3	3606480995019	<b>CSU795387</b>
W13/40-70	38/267/267		64	7321677179138	<b>717913</b>
W13/40-100	38/297/297		80	7321677179145	<b>717914</b>
W13/40-200	38/397/397		150	7321677179152	<b>717915</b>
W13/40-300	38/497/497		240	7321677179169	<b>717916</b>
W13/40-400	38/597/597		350	7321677179176	<b>717917</b>
W13/40-500	38/697/697		480	7321677211883	<b>721188</b>
W13/40-600	38/797/797		630	7321677232000	<b>723200</b>
<b>X-junction to be used for 90° horizontal junction of cable trays W1/60 and W3/60. Push-in assembly. Material: Sheet steel, pre-galvanized.</b>					
W13/60-70	58/268/268		62	7321677820955	<b>782095</b>
W13/60-100	58/298/298		78	7321677820962	<b>782096</b>
W13/60-150	58/348/348		110	7321677820979	<b>782097</b>
W13/60-200	58/398/398		146	7321677820986	<b>782098</b>
W13/60-300	58/498/498		234	7321677820993	<b>782099</b>
W13/60-400	58/598/598		342	7321677821006	<b>782100</b>
W13/60-500	58/698/698		469	7321677821013	<b>782101</b>
W13/60-600	58/798/798		616	7321677821020	<b>782102</b>
W13/60-500 FS	58/698/698		328	7321677824625	<b>782462</b>
W13/60-600 FS	58/798/798		441	7321677824632	<b>782463</b>
<b>Cover plate W16</b>					
Cover plate to be used to level out the differences in level between cable tray and junctions, such as 90° bends, T- and X-junctions. To be mounted under the junctions. Material: Sheet steel, pre-galvanized.					
W16-70	1.5/70/70		6	7321677180363	<b>718036</b>
W16-100	1.5/100/100		12	7321677180370	<b>718037</b>
W16-200	1.5/200/200		48	7321677180387	<b>718038</b>
W16-300	1.5/300/300		108	7321677180394	<b>718039</b>
W16-400	1.5/400/400		192	7321677180400	<b>718040</b>

P151354



717910



782055



P151356

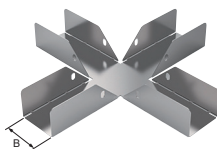

717915



782098



ODAY18038





## Vertical risers

Type	Dimensions A/B/C mm		Weight kg/100 pcs	EAN code	Ref. No.
<b>Vertical riser W11</b>					
Vertical riser to be used as internal or external riser for cable tray W1/40 and W3/40. The riser is delivered flat and can be bent to the desired angle up to 90°. Push-in assembly. Material: Sheet steel, pre-galvanized.					
W11/40-50	-/48/150		8	7321677334988	<b>733498</b>
W11/40-70	-/68/150		10	7321677232260	<b>723226</b>
W11/40-100	-/98/150		12	7321677232277	<b>723227</b>
W11/40-150	-/148/150		17	7321677334995	<b>733499</b>
W11/40-200	-/198/200		28	7321677232284	<b>723228</b>
W11/40-300	-/298/200		39	7321677232291	<b>723229</b>
W11/40-400	-/398/200		50	7321677232307	<b>723230</b>
W11/40-500	-/498/200		61	7321677232314	<b>723231</b>
W11/40-600	-/598/200		73	7321677232321	<b>723232</b>
<b>Vertical riser W11</b>					
Vertical riser to be used as internal or external riser for cable tray W1/60 and W3/60. The riser is delivered flat and can be bent to the desired angle up to 90°. Push-in assembly. Material: Sheet steel, pre-galvanized.					
W11/60-70	-/67/150		12	7321677822768	<b>782276</b>
W11/60-100	-/97/150		15	7321677822775	<b>782277</b>
W11/60-150	-/147/150		19	7321677822782	<b>782278</b>
W11/60-200	-/197/200		31	7321677822799	<b>782279</b>
W11/60-300	-/297/200		42	7321677822805	<b>782280</b>
W11/60-600	-/397/200		53	7321677822812	<b>782281</b>
W11/60-500	-/497/200		64	7321677822829	<b>782282</b>
W11/60-600	-/597/200		75	7321677822836	<b>782283</b>
<b>Vertical riser W4</b>					
Vertical riser suitable for installation tray W4. To be used as internal or external riser. The riser is delivered flat and can be bent to the desired angle up to 90°. Push-in assembly. Material: Sheet steel, pre-galvanized.					
W4-50	16/52/250		15	7321677840892	<b>784089</b>
W4-75	16/77/250		19	7321677840908	<b>784090</b>
W4-100	16/102/250		24	7321677840915	<b>784091</b>
W4-150	16/152/250		33	7321677840922	<b>784092</b>
W4-200	16/202/250		42	7321677840939	<b>784093</b>
W4-250	16/252/250		58	7321677840946	<b>784094</b>
W4-300	16/302/250		68	7321677840953	<b>784095</b>
W4-400	16/402/250		77	7321677840960	<b>784096</b>

0DA723228



782279



784093

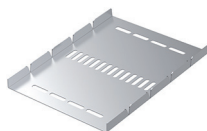

### Reducers

Type	Dimensions A/B/C mm		Weight kg/100 pcs	EAN code	Ref. No.
<b>Reducer W28/40</b>					
Reducer for cable tray W1/W3, system height 40. To be used together with side joint W49 in side transitions. In centered transitions only two reducers W28 are necessary. Material: Sheet steel, pre-galvanized.					
W28/40-50	37.5/50/200		15	7321677935710	<b>793571</b>
W28/40-100	37.5/100/200		17	7321677874361	<b>787436</b>
W28/40-150	37.5/150/200		20	7321677935727	<b>793572</b>
W28/40-200	37.5/200/200		23	7321677874378	<b>787437</b>
W28/40-250	37.5/250/200		26	7321677935734	<b>793573</b>
W28/40-300	37.5/300/200		29	7321677935741	<b>793574</b>
W28/40-350	37.5/350/200		32	7321677935758	<b>793575</b>
W28/40-400	37.5/400/200		36	7321677935765	<b>793576</b>
W28/40-450	37.5/450/200		39	7321677935772	<b>793577</b>
W28/40-500	37.5/500/200		41	7321677935789	<b>793578</b>
<b>Reducer W28/60</b>					
Reducer for cable tray W1/W3, system height 60. To be used together with side joint W49 in side transitions. In centered transitions only two reducers W28 are necessary. Material: Sheet steel, pre-galvanized.					
W28/60-50	57.5/50/200		22	7321677936076	<b>793607</b>
W28/60-100	57.5/100/200		27	7321677874422	<b>787442</b>
W28/60-150	57.5/150/200		31	7321677936083	<b>793608</b>
W28/60-200	57.5/200/200		36	7321677874439	<b>787443</b>
W28/60-250	57.5/250/200		40	7321677936090	<b>793609</b>
W28/60-300	57.5/300/200		45	7321677936106	<b>793610</b>
W28/60-350	57.5/350/200		49	7321677936113	<b>793611</b>
W28/60-400	57.5/400/200		54	7321677936120	<b>793612</b>
W28/60-450	57.5/450/200		58	7321677936137	<b>793613</b>
W28/60-500	57.5/500/200		63	7321677936144	<b>793614</b>

### End covers

<b>End cover W45</b>					
End cover to be mounted at the ends of cable trays W1/40 and W3/40 and of lighting trunking W70. Provided with oval holes 6x55 mm on the sides. Push-in assembly. Material: Sheet steel, pre-galvanized.					
W45/40-70	38/100/68		8	7321677317301	<b>731730</b>
W45/40-100	38/100/98		9	7321677317318	<b>731731</b>
W45/40-200	38/100/198		12	7321677317325	<b>731732</b>
W45/40-300	38/100/298		15	7321677317332	<b>731733</b>
W45/40-400	38/100/398		18	3303432388423	<b>731734</b>
W45/40-500	38/100/498		21	7321677317356	<b>731735</b>
W45/40-600	38/100/598		24	7321677317363	<b>731736</b>
<b>End cover W60</b>					
End cover to be mounted at the ends of cable trays W1/60 and W3/60. Provided with oval holes 6x55 mm on the sides. Push-in assembly. Material: Sheet steel, pre-galvanized.					
W45/60-70	58/100/68		12	7321677822928	<b>782292</b>
W45/60-100	58/100/98		13	7321677822935	<b>782293</b>
W45/60-200	58/100/198		18	7321677822942	<b>782294</b>
W45/60-300	58/100/298		23	7321677822959	<b>782295</b>
W45/60-600	58/100/398		28	7321677822966	<b>782296</b>
W45/60-500	58/100/498		34	7321677822973	<b>782297</b>
W45/60-600	58/100/598		39	7321677822980	<b>782298</b>

#### Box plates

Type	Dimensions A/B/C mm		Weight kg/100 pcs	EAN code	Ref. No.
<b>Junction box plate W24</b>					
Junction box plate, with or without perforated hole pattern. To be used for the installation of junction boxes, light fittings, etc., in cable trays W1/40 and W3/40 and in lighting trunking W70. Material: Sheet steel, pre-galvanized.					
W24/40	161/43/200		27	7321677179954	<b>717995</b>
W24/40 non-perforated	161/43/200		31	7321677302475	<b>730247</b>
<b>Junction box plate W24/60</b>					
Junction box plate, with perforated hole pattern. To be used for the installation of junction boxes, light fittings, etc., in cable trays W1/60 and W3/60. Material: Sheet steel, pre-galvanized.					
W24/60	179/43/200		34	7321677181933	<b>718193</b>
<b>Earth clamp W79</b>					
Earth clamp to be used when protective earthing of the junction box plate is required. Material: Steel, electro-galvanized.					
W79	Screw M4/-/4.5		0.2	7321677166404	<b>716640</b>

#### Outlet and junction box sets

<b>Junction box set</b>					
Junction box set including junction box plate W24/40 and a pre-mounted junction box UP, IP-class IP65. Material: Sheet steel, pre-galvanized.					
Junction box set	161/50/200		39	7321677319633	<b>731963</b>
<b>Outlet set</b>					
Outlet set including junction box plate W24/40 and a pre-mounted outlet, 2-way. Material: Sheet steel, pre-galvanized.					
Outlet set	161/53/200		36	7321677342273	<b>734227</b>

#### Luminaire brackets

<b>Luminaire bracket W25</b>					
Luminaire bracket to be used for assembly of lighting fixtures under Cable trays W1/40 and W3/40 or Lighting trunking W70. Material: Sheet steel, pre-galvanized.					
W25/40-70	62/30/72		7	7321677139118	<b>713911</b>
W25/40-100	62/30/101		8	7321677139125	<b>713912</b>
W25/40-200	62/30/201		11	7321677139149	<b>713914</b>
W25/40-300	62/30/301		19	7321677139163	<b>713916</b>
W25/40-400	62/30/401		23	7321677139170	<b>713917</b>
W25/40-500	62/30/501		27	7321677139187	<b>713918</b>
W25/40-600	62/30/601		31	7321677139132	<b>713913</b>
<b>Luminaire bracket W25/60</b>					
Luminaire bracket to be used for assembly of lighting fixtures under Cable trays W1/60 and W3/60. Material: Sheet steel, pre-galvanized.					
W25/60-70	82/30/72		7.7	7321677822843	<b>782284</b>
W25/60-100	82/30/101		8.6	7321677822850	<b>782285</b>
W25/60-200	82/30/201		14	7321677822867	<b>782286</b>
W25/60-300	82/30/301		18	7321677822874	<b>782287</b>
W25/60-400	82/30/401		23	7321677822881	<b>782288</b>
W25/60-500	82/30/501		27	7321677822898	<b>782289</b>
W25/60-600	82/30/601		32	7321677822904	<b>782290</b>
<b>Luminaire bracket W50</b>					
Luminaire bracket to be used to mount lighting fixtures between two parallel Cable trays W1/W3 or Lighting trunking W70. Dimension A (* height) is specified when ordering and is depending on the height of the lighting fixture. The weight (**) is calculated for a bracket with a height of 100 mm. Material: Sheet steel, pre-galvanized.					
W50	* /30/250		25**	7321677205202	<b>720520</b>
<b>Luminaire bracket W35</b>					
Luminaire bracket to be used to mount centralized lighting fixtures under Lighting trunking W70. Material: Sheet steel, pre-galvanized.					
W35	15/30/70		3	7321677156504	<b>715650</b>

### Luminaire brackets

PTCSU-0041



Type	Dimensions A/B/C mm		Weight kg/100 pcs	EAN code	Ref. No.
<b>Luminaire bracket W55</b>					
Luminaire bracket to be used to mount lighting fixtures under Lighting trunking W70. Material: Sheet steel, pre-galvanized.					
W55	16/12/42		8	7321677209798	<b>720979</b>

### Integrated ceiling parts

717990



<b>Shade ledge W26</b>					
Shade ledge to be used as a support for ceilings mounted between cable trays with system height 40 mm. Suspended over the lateral side of the cable tray. Also suitable for Lighting trunking W70. Material: Sheet steel, pre-galvanized.					
W26/40	51/41/2000		154	7321677179909	<b>717990</b>

PTCSU-0034



Shade ledge to be used as a support for ceilings mounted between cable trays with system height 60 mm. Suspended over the lateral side of the cable tray. Material: Sheet steel, pre-galvanized.					
W26/60	60/42/2000		185	7321677185597	<b>718559</b>

PTCSU-0003



<b>Ceiling support W27</b>					
Integrated support channel to be used as a support for false ceilings mounted between cable trays with system height 60 mm. Suspended over the lateral side of the cable tray. Material: Sheet steel, pre-galvanized.					
W27/60	60/25/2000		160	7321677185566	<b>718556</b>

PTCSU-0004



<b>Locking clamp W77</b>					
Locking clamp to be used when pendant rail W32 is mounted between two parallel lighting trunking W70 or cable trays W1/W3 for additional stability. Material: Sheet steel, pre-galvanized.					
W77	12/40/47		1.5	7321677167975	<b>716797</b>



## Screws, bolts and nuts

	Type	Dimensions A/B/C mm		Weight kg/100 pcs	EAN code	Ref. No.
PI40156	<b>Screw set W34</b>	Screw set to be used for mounting of Cable tray W3 onto Cantilever arm 50, Locking clamp W77 and Angle bracket W8 onto Pendant rail W32, Junction box plate W24 onto W3 Cable tray or Lighting trunking W70, as well as for assembly of Angle bracket W8 (light fitting bracket) and for joining of W4 Installation trays. Set including screw MSCS 6x12 and nut M6MF 6. Material: Steel, electro-galvanized.				
	W34	10/10/16		0.8	7321677184736	<b>718473</b>
715646	<b>Screw set W36</b>	Screw set including bolt and nut M8 to be used for the mounting of single Pendant attachment W21 or Tube pendant attachment W73 on Support bracket/joint W7. Material: Steel, electro-galvanized.				
	W36	M8		1.2	7321677156467	<b>715646</b>
783500	<b>Screw set W36C</b>	Screw set including bolt with slotted screw head and nut M8. To be used for the mounting of single Pendant attachment W21 or Tube pendant attachment W73 on Support bracket/joint W7. Material: Steel, electro-galvanized.				
	W36C	M8		1.8	7321677835003	<b>783500</b>
716799	<b>Screw set W37</b>	Screw set including bolt MVBF 8x35 and nut M6MF 8, to be used for assembly of Pendant attachment W21 and Ceiling attachment W31 with Pendant rail W32, and for the joining of Pendant rail W32. Material: Steel, electro-galvanized.				
	W37	M8		2.8	7321677167999	<b>716799</b>
00A735177	<b>Screw set W38P C4</b>	Screw set including screw and nut, to be used for the mounting of joints, bends, junctions, shade ledge W26 and integrated ceiling support channel W27. The patented screw set pierces through painted surfaces securing potential balancing. N.B. The joints must be unpainted. Material: Steel. Corrosion class: C4.				
	W38P	–		0.4	7321677351770	<b>735177</b>
00A721868	<b>Screw W40</b>	Screw (RXS ST 5.5x13-H) to be used for the locking of T-joint W29 in open junctions. Material: Steel, electro-galvanized.				
	W40	–		0.3	7321677218684	<b>721868</b>
T-bolt single-10	<b>T-bolt 26U</b>	T-bolt to be used for mounting with all vertical pieces (except Vertical piece 2) and with Pendant/fixing rail 24/48. Material: Steel, electro-galvanized.				
	26U M8x30	50/44/18		6.8	3606489579760	<b>CSU795594</b>
	26U M10x30	50/44/18		6.8	3606489579708	<b>CSU795588</b>
PTCSU-0007	<b>Locking plug W41</b>	Locking plug to be used for quick locking of joints, bends and branches in cable trays and lighting trunking. Material: PP+GF10.				
	W41	Ø14/10.5		0.1	7321677186457	<b>718645</b>

# Steel cable trays

Pre-galvanized  
Corrosion class C2

## Threaded rods

Type	Dimensions A/B/C mm		Weight kg/100 pcs	EAN code	Ref. No.
<b>Threaded rod W76</b>					
Threaded rod M6 to be used for light-duty cable tray W1/W3 and lighting trunking W70 suspensions. Material: Steel, electro-galvanized.					
W76 M6	1000/6/6		18	7321677840618	<b>784061</b>
W76 M6	2000/6/6		36	7321677929344	<b>792934</b>
W76 M6	3000/6/6		54	7321677929351	<b>792935</b>
Threaded rod M8 and M10 to be used to suspend cable tray W1/W3 and lighting trunking W70 installations. Material: Steel, electro-galvanized.					
W76 M8	1000/8/8		32	7321677250790	<b>725079</b>
W76 M10	2000/10/10		100	7321677167920	<b>716792</b>
W76 M10	3000/10/10		150	7321677167937	<b>716793</b>
<b>Joint nut M6, M8, M10</b>					
Joint nut to be used to connect two lengths of threaded rods W76. Material: Steel, electro-galvanized.					
Joint nut M6	30/11.5/10		1.2	7321677840632	<b>784063</b>
Joint nut M8	40/15/13		5.0	7321677250837	<b>725083</b>
Joint nut M10	40/18.5/16		7.2	7321677248063	<b>724806</b>
<b>Thread lock B50</b>					
Thread lock M8 and M10 to be used to connect two lengths of threaded rods. Provides a quick and screw-less height adjustment of the threaded rod. Material: Steel, electro-galvanized.					
B50/M8	10/20/35		1	7332227014564	<b>1149456</b>
B50/M10	12/24/35		2	7332227014663	<b>1149466</b>
<b>Flange nut M6</b>					
Flange nut to be used to mount support brackets and ceiling brackets onto threaded rods W76. Material: Steel, electro-galvanized.					
Flange nut M6	M6		0.4	7321677840625	<b>784062</b>
<b>Flange nut B43</b>					
Flange nut to be mounted onto Threaded rod W76 in order to lock it to the Support hook and the Ceiling fittings. Package of 50 pcs. Material: Steel, electro-galvanized.					
B43/M8	17/17/8		0.4/bag	7321677888474	<b>1149405</b>
B43/M10	20/20/15		0.56/bag	7332227014649	<b>1149464</b>
<b>Pendant attachment W73</b>					
Tube pendant attachment to be used for mounting of threaded rod W76 M6/M10 in ceiling and cable tray W1/W3 and lighting trunking W70/71. Provides a quick and screw-less height adjustment of the threaded rod. Material: Sheet steel, pre-galvanized.					
W73 M6	135/26/56		7	7321677912056	<b>791205</b>
W73 M10	135/26/56		7	7321677166343	<b>716634</b>

csu08050000



csu08050000



P140074



PTCSL0043



P140094



P140154



P140154



PTCSL0001



### Ogebe fixings

716474



Type	Dimensions A/B/C mm	Weight kg/100 pcs	EAN code	Ref. No.
<b>Ogebe fixings</b>				
Ogebe fixing type E to be used for mounting in 0.7-0.9 mm sheeting or board material. Examples are hole straps, pendants, ducts, trays and piping. Material: Steel, elctro-galvanized.				
Type E	40/25/48	4.8	7321677164745	<b>716474</b>

### Brackets

PTCSU-0037



<b>Support bracket W1940</b>				
Support bracket to be used for invisible installation of cable trays W1/40 and W3/40. Material: Sheet steel, pre-galvanized.				
W1940-100	36/65/90	11	7321677187119	<b>718711</b>
W1940-200	36/65/190	22	7321677344017	<b>734401</b>
W1940-300	36/65/289	50	7321677344024	<b>734402</b>
W1940-400	36/65/389	68	7321677344031	<b>734403</b>
W1940-500	36/65/489	91	7321677823420	<b>782342</b>
W1940-600	36/65/589	110	7321677823437	<b>782343</b>

PTCSU-0037



<b>Support bracket W1960</b>				
Support bracket to be used for invisible installation of cable trays W1/60 and W3/60. Material: Sheet steel, pre-galvanized.				
W1960-100	56/65/89	19	7321677823321	<b>782332</b>
W1960-200	56/65/189	37	7321677823338	<b>782333</b>
W1960-300	56/65/289	58	7321677823345	<b>782334</b>
W1960-400	56/65/389	77	7321677823352	<b>782335</b>
W1960-500	56/65/489	96	7321677823369	<b>782336</b>
W1960-600	56/65/589	115	7321677823376	<b>782337</b>

PTCSU-0044



<b>Support bracket W20</b>				
Support bracket to be used for invisible installation of lighting trunking W70/71, width 70 and 100 mm. The support bracket is snapped firmly into the trunking. Two nuts M10 are included. Suitable for threaded rod W76 M10. Material: Sheet steel, pre-galvanized.				
W20-70	–	9	7321677209736	<b>720973</b>
W20-100	–	13	7321677219438	<b>721943</b>

PTCSU-0038



<b>Support bracket W20A</b>				
Support bracket to be used for invisible installation of lighting trunking W70/71, width 70 and 100 mm. The support bracket is snapped firmly into the trunking. The spring locking device facilitates easy vertical height adjustment. Suitable for threaded rod W76 M10. Material: Sheet steel, pre-galvanized.				
W20A-70	145/75/66	15	7321677209705	<b>720970</b>
W20A-100	148/89/90	20	7321677211807	<b>721180</b>

PTCSU-0049



### Cantilever arms

Type	Dimensions A/B/C mm		Weight kg/100 pcs	EAN code	Ref. No.
<b>Cantilever arm 50i</b>					
Cantilever arm to be used for mountings on walls, vertical pieces or pendant/fixing rails. Dimensions 500 and 600 marked with * will be available in middle of July 2016. Material: Steel, pre-galvanized.					
50i-100	80/150/43		19	7321677914128	<b>791412</b>
50i-200	85/250/43		29	7321677914135	<b>791413</b>
50i-300	110/350/43		46	7321677914142	<b>791414</b>
50i-400	115/450/44		83	7321677914159	<b>791415</b>
50i/500 *	130/580/50		160	3606480911354	<b>CSU795322</b>
50i/600 *	130/680/50		186	3606480911361	<b>CSU795323</b>
<b>Internal cantilever arm W17</b>					
Internal cantilever arm to be used for invisible mounting inside cable tray W1/40 and W3/40. Material: Sheet steel, pre-galvanized.					
W17-100	140/55/119		16	7321677169115	<b>716911</b>
W17-200	140/55/219		35	7321677169122	<b>716912</b>
W17-300	165/75/319		80	7321677169139	<b>716913</b>
W17-400	165/75/419		100	7321677169146	<b>716914</b>
<b>Adjustable internal cantilever arm W1840</b>					
Adjustable internal cantilever arm to be used for invisible mounting inside cable trays W1/40 and W3/40. Adjustability 0-25 mm (W1840-100) and 0-50 mm (W1840-200 to 600). Material: Sheet steel, pre-galvanized.					
W1840-100	160/60/88		36	7321677183609	<b>718360</b>
W1840-200	160/60/188		47	7321677183616	<b>718361</b>
W1840-300	185/60/289		120	7321677835874	<b>783587</b>
W1840-400	185/60/389		139	7321677835881	<b>783588</b>
W1840-500	185/60/489		156	7321677835898	<b>783589</b>
W1840-600	185/60/589		175	7321677835904	<b>783590</b>
<b>Adjustable internal cantilever arm W1860</b>					
Adjustable cantilever arm to be used for invisible mounting inside cable trays W1/60 and W3/60. Adjustability 0-25 mm (W1860-100 length) and 0-50 mm (W1860-200-600). Material: Sheet steel, pre-galvanized.					
W1860-100	160/60/89		47	7321677823925	<b>782392</b>
W1860-200	160/60/189		65	7321677823932	<b>782393</b>
W1860-300	185/60/289		123	7321677823949	<b>782394</b>
W1860-400	185/60/389		142	7321677823956	<b>782395</b>
W1860-500	185/60/489		161	7321677823963	<b>782396</b>
W1860-600	185/60/589		180	7321677823970	<b>782397</b>
<b>Pendant bracket W80</b>					
Pendant bracket W80 mounted under lighting trunking W70-50 and attached with screw set W36/W36C. Threaded rod W76 M6 is easily mounted in the spring clasp without bolts. Adjustable to ± 30 mm. Material: Sheet steel, pre-galvanized.					
W80 M6	160/35/76		5.4	3606480994890	<b>CSU795371</b>
<b>Pendant bracket W81</b>					
Pendant bracket W81 is mounted under lighting trunking W70-50 and is attached with screw set W37. Pendant rail W32 is mounted using screw set W37. Adjustable to ± 18mm. Material: Sheet steel, hot-dip galvanized.					
W81 M6	140/2/76		4.1	3606480994913	<b>CSU795377</b>
<b>Wire bracket W70-50</b>					
Wire bracket for screwless fixation, central suspension of lighting trunking w70-50. Material: Steel, hot-dip galvanized.					
Wire bracket	70/52/58		2.2	3606480994883	<b>CSU795370</b>
<b>Back plate W30</b>					
Back plate to be used for wall installation of internal cantilever arms on porous walls, to reduce the surface pressure. Material: Sheet steel, pre-galvanized.					
W30	135/3/135		42	7321677867929	<b>786792</b>

P138832



PTCSU-0005



782393



782393



P151350



P151351



P151349



PTCSU-0039



### Vertical pieces

Type	Dimensions A/B/C mm		Weight kg/100 pcs	EAN code	Ref. No.
<b>Vertical piece 2Fi</b>					
Vertical piece to be used for lighter mountings with Cantilever arm 50i. Material: Steel, pre-galvanized.					
2Fi-300	272/134/54		97	7321677927234	<b>792723</b>
2Fi-500	497/134/54		137	7321677927241	<b>792724</b>
2Fi-750	722/134/54		177	7321677927258	<b>792725</b>
2Fi-1000	922/134/54		225	7321677927265	<b>792726</b>
<b>Pendant strip W33</b>					
Pendant strip to be used as a light-duty vertical ceiling suspension. The pendant strip is delivered in a straight length of 1 m, to be bent on site. Pendants longer than 1 m are joined by overlapping, using Screw set W36/W36C. Material: Sheet steel, pre-galvanized.					
W33	1000/25/-		19	7321677217861	<b>721786</b>
<b>End bracket WN17</b>					
End bracket to be used as a vertical piece on Support bracket/joint W7 to achieve a concealed suspension. Material: Sheet steel, pre-galvanized.					
WN17	220/23/30		10	7321677330904	<b>733090</b>

### Ceiling brackets

<b>Ceiling attachment W31</b>					
Ceiling attachment to be used for installations with Pendant rail W32. Material: Sheet steel, pre-galvanized.					
W31	70/64/25		6.5	7321677168163	<b>716816</b>
<b>Ceiling bracket 5</b>					
Ceiling bracket to be used for installations with Pendant/Fixing rails 24/34 and 24/48. Screw not included. Material: Steel, pre-galvanized.					
5	100/135/40		35	7321677211012	<b>721101</b>
<b>Ceiling bracket 5TPA</b>					
Ceiling bracket with telescopic function, to be used for mounting of various sizes of trapezoid plates. Including screw MVBF 8x16 and nut M6MF8. Breaking load: 150 kg without deformation. Material: Steel, pre-galvanized.					
5TPA	50/76/79-118		14	7321677321773	<b>732177</b>
<b>Ceiling bracket 5TP</b>					
Ceiling bracket to be used in trapezoidal sheeting for installations of Pendant/Fixing rail 24/48. Material: Steel, pre-galvanized.					
5TP	71/35/50		12	7321677253623	<b>725362</b>
<b>Ceiling bracket 2Fi</b>					
Ceiling bracket to be used on Pendant/fixing rail 24/48 to achieve the desired length of vertical pieces. Material: Steel, pre-galvanized.					
2Fi	131/134/54		50	7321677925544	<b>792554</b>



## Pendant/Fixing rails

Type	Dimensions A/B/C mm	Weight kg/100 pcs	EAN code	Ref. No.
<b>Pendant rail W32</b>				
Pendant rail to be installed in ceilings in combination with ceiling attachment W31 or Ogebe fixing type E. Material: Sheet steel, pre-galvanized.				
W32	3000/20/20	180	7321677167982	<b>716798</b>
<b>Pendant/Fixing rail 24/34</b>				
Pendant/Fixing rail to be used for the mounting of support brackets, cantilever arms, etc. Material: Sheet steel, pre-galvanized.				
24/34	293/16/42	23	7321677253579	<b>725357</b>
24/34	383/16/42	31	7321677253586	<b>725358</b>
24/34	495/16/42	40	7321677253593	<b>725359</b>
24/34	698/16/42	56	7321677253609	<b>725360</b>
24/34	990/16/42	80	7321677253616	<b>725361</b>
24/34	2970/16/42	240	7321677211029	<b>721102</b>
<b>Pendant/Fixing rail 24/48</b>				
Pendant/Fixing rail for mounting of support brackets, cantilever arms, etc. Material: Steel, pre-galvanized.				
24/48	1000/26/48	175	3606481317858	<b>CSU795564</b>
24/48	2970/26/48	520	7321677317172	<b>731717</b>
24/48	5940/26/48	1120	7321677317219	<b>731721</b>
<b>Pendant attachment W21</b>				
Pendant attachment to be used in combination with pendant rail W32, support bracket/joint W7, etc. Material: Sheet steel, pre-galvanized.				
W21	97/50/21	12	7321677166305	<b>716630</b>

## Pendant bars

<b>Pendant bar 1</b>				
Pendant bar to be installed in order to reduce the deflection of heavily loaded vertical pieces. Installed with T-bolt and Expansion bolt. Material: Steel, pre-galvanized.				
1-300	315/161/40	35	7321677927272	<b>792727</b>
1-500	515/166/40	53	7321677927289	<b>792728</b>
1-800	815/246/40	82	7321677927296	<b>792729</b>





## Angle brackets

<b>Angle bracket W8</b>				
Angle bracket to be mounted inside a cable tray W1/W3 for horizontal installation to the wall or vertical installation to the floor. Can also be mounted as a pendant bracket in the lighting trunking W70. Material: Sheet steel, pre-galvanized.				
W8	80/38/45	6	7321677168217	<b>716821</b>
<b>Angle bracket W8S</b>				
Universal angle bracket to be used for various installations of pendant/fixing rail 24/34, support bracket, etc. Material: Sheet steel, pre-galvanized.				
W8S	120/30/30	8	7321677280711	<b>728071</b>



## Pendant joint

<b>Pendant joint 2FJ</b>				
Pendant joint to be used for joining pendant/fixing rails and vertical pieces. Screws M8x16 and nuts included. Material: Steel, pre-galvanized.				
2FJ	200/18/55	46	3606480911385	<b>CSU795325</b>



## Lashing wires

Type	Dimensions A/B/C mm		Weight kg/100 pcs	EAN code	Ref. No.
<b>Lashing wire</b>					
Lashing wire to be used for lashing of wires on cable ladders. Material: Stainless steel, PVC.					
P140226 	HTR-2303, white PVC	Ø1.25	1.3/100 m	7321677136865	<b>713686</b>
P140225 	HTR-2313, black PVC	Ø1.25	1.3/100 m	7321677136872	<b>713687</b>
Lashing wire to be used for lashing of wires on cable ladders. Material: PVC.					
P140228 	HT-2304, white	Ø1.5	1.8/100 m	7321677136841	<b>713684</b>
P140225 	HT-2314, black	Ø1.5	1.8/100 m	7321677136858	<b>713685</b>

## End plugs

<b>End plug 28C and E</b>					
End plug to be mounted on pendant ends to provide protection against personal injury and to make the ends of the profiles more conspicuous. Material: PP/TPE, orange.					
P140087 	28C for Vertical piece 2 and Pendant/fixing rail 24/34	25/19/46	0.5	7321677898756	<b>789875</b>
P140089 	28E for Vertical piece 2F and Pendant/fixing rail 24/48, Pendant Fixing rail 24/48 and CLX <sup>3</sup> Pendant Fixing rail 24/48.	24/30/52	0.5	7321677090211	<b>709021</b>

## Accessories

<b>Strip fixing W44</b>					
Strip fixing to be used for easy fixation of cables in an unperforated cable tray W1/40 or W1/60. Material: PPE.					
P148804 	W44	5.5/25/96	1	7321677184699	<b>718469</b>
<b>Protection strip W48</b>					
Protection strip to be used to protect cables from sharp edges when cutting the cable tray W1/W3 or lighting trunking W70. Material: Plastic.					
PTCSU-0013 	W48	10/6/720	6.1	7321677872114	<b>787211</b>
<b>Repair paint</b>					
Anti-corrosive repair paint GalvaFroid in a 0.4 l tin for the repair of damages on pre-galvanized or hot-dip galvanized trays and accessories.					
P148450 	Anti-corrosive repair paint	–	104	7321677176373	<b>717637</b>

# Reliable, functional and flexible. CLX<sup>3</sup> is optimized to deliver for a range of applications.



CLX<sup>3</sup> is engineered for all commercial buildings – from modern offices, and state-of-the-art automated distribution centers, to luxurious consumer shopping facilities.

## Central Wibe cable tray support

- The CLX<sup>3</sup> support system in combination with the Wibe Cable tray is designed to effectively conceal the cables and support brackets, thereby enhancing the aesthetics of the cable routing installation.
- The system is developed to function in synergy with interior design requirements.
- The smooth and rounded design of the bracket helps prevent damage to cables.



#### Vertical piece/Fixing rail

Type	Dimensions A/B/C mm	Weight kg/100 pcs	EAN code	Ref. No.
<b>CLX<sup>3</sup> pendant 24/48</b>				
Vertical piece/pendant to be used for ceiling suspended mounting. Perforated pattern to be used with CLX <sup>3</sup> cantilever arm or CLX <sup>3</sup> central suspension adapter. Open side can be used with T-bolt. Material: Steel, pre-galvanized.				
CLX <sup>3</sup> pendant-300	295/145/53	90.6	3606489904937	<b>CSU795632</b>
CLX <sup>3</sup> pendant-400	395/145/53	107.5	3606489904944	<b>CSU795633</b>
CLX <sup>3</sup> pendant-500	495/145/53	124.4	3606489904951	<b>CSU795634</b>
CLX <sup>3</sup> pendant-700	695/145/53	158.1	3606489904968	<b>CSU795635</b>
CLX <sup>3</sup> pendant-1000	995/145/53	208.7	3606489904975	<b>CSU795636</b>
CLX <sup>3</sup> pendant-1500	1495/145/53	294.2	3606481828323	<b>CSU795638</b>

PTCSU-181



#### CLX<sup>3</sup> pendant rail 24/48

Pendant rail to be used for direct wall mounting or for vertical piece/pendants extensions. To be connected to the vertical piece/pendant together with the pendant joint CSU795325. Perforated pattern to be used with CLX<sup>3</sup> cantilever arm. Open side can be used with T-bolt.  
Material: Steel, pre-galvanized.

CLX <sup>3</sup> rail 24/48 300	280/48/26	47.2	3606481828330	<b>CSU795640</b>
CLX <sup>3</sup> rail 24/48 1000	980/48/26	165.1	3606481828347	<b>CSU795641</b>
CLX <sup>3</sup> rail 24/48 3000	2980/48/26	502	3606489904982	<b>CSU795637</b>

PTCSU-186



#### Adjustable ceiling plate

#### CLX<sup>3</sup> adjustable ceiling plate

Adjustable ceiling plate. To be used for angular adjustment of pendant vs ceiling. Adjustment between 0-25°. Adjustable ceiling plate is to be mounted to the CLX<sup>3</sup> pendant. To be assembled with 4 screw set 22S (713694), need to be ordered separately. Tightening force of the screw set minimum torque 20 N.m.  
Material: Steel, pre-galvanized.

CLX <sup>3</sup> adjustable ceiling plate	150/100/59	49.8	3606489904999	<b>CSU795639</b>
---	------------	------	---------------	------------------

PTCSU-187



#### Central suspensions

#### CLX<sup>3</sup> central suspension bracket, cable tray H40

Central suspension bracket used for mounting Wibe cable W1/W3/W70 trays height 40 on vertical pieces.  
Material: Steel, pre-galvanized.

70	152/37/66	16.5	3606489905088	<b>CSU795653</b>
100	152/37/96	18	3606489905095	<b>CSU795654</b>

PTCSU-185



200 *	36/76/196	26.8	3606489905156	<b>CSU795660</b>
300 *	36/76/296	46	3606489905163	<b>CSU795661</b>
400 *	36/76/396	65.3	3606489905170	<b>CSU795662</b>
500 *	36/76/496	84.6	3606489905187	<b>CSU795663</b>
600 *	36/76/596	103.9	3606489905194	<b>CSU795664</b>

PTCSU-187



(\* ) the central suspension bracket shall first be assembled together with the CLX<sup>3</sup> central suspension adapter (CSU795700) to be able to click in the perforation pattern on the vertical piece.

#### CLX<sup>3</sup> central suspension adapter

Central suspension adapter to be first clicked to a CLX<sup>3</sup> central suspension bracket of choice. The adaptor fits to all types of CLX<sup>3</sup> central suspension brackets; ladder, tray and mesh. In a second step the adaptor with the central suspension bracket mounted is clicked in the perforation pattern in the rail or the pendant.  
Material: Steel, pre-galvanized.

CLX <sup>3</sup> CSB adapter	166/31/39	17.7	3606489905248	<b>CSU795700</b>
------------------------------	-----------	------	---------------	------------------

PTCSU-211



# Steel cable trays

Pre-galvanized white

Corrosion class C2

## Cable trays, unperforated

Type	Dimensions A/B/C mm		Weight kg/100 m	EAN code	Ref. No.
------	------------------------	---	--------------------	----------	----------

### Cable tray W1

Unperforated cable tray for indoor applications in dry environments. System height 40 mm. Provided with holes Ø 5.8 mm at the tray end to be used for fixation of joints.

Material: Steel, pre-galvanized, powder-coated white.

W1/40-70	40/70/2000		95	7321677289868	<b>728986</b>
	40/70/3000		95	7321677813346	<b>781334</b>
W1/40-100	40/100/2000		115	7321677289875	<b>728987</b>
	40/100/3000		115	7321677813353	<b>781335</b>
W1/40-200	40/200/2000		170	7321677289882	<b>728988</b>
	40/200/3000		170	7321677813360	<b>781336</b>
W1/40-300	40/300/2000		400	7321677289899	<b>728989</b>
	40/300/3000		400	7321677813377	<b>781337</b>
W1/40-400	40/400/2000		500	7321677289905	<b>728990</b>
	40/400/3000		500	7321677813384	<b>781338</b>
W1/40-500	40/500/2000		710	7321677289912	<b>728991</b>
	40/500/3000		710	7321677813391	<b>781339</b>
W1/40-600	40/600/2000		825	7321677289929	<b>728992</b>
	40/600/3000		825	7321677813407	<b>781340</b>
W1/40-500 FS	40/500/2000		715	7321677868339	<b>786833</b>
W1/40-600 FS	40/600/2000		830	7321677868346	<b>786834</b>

Unperforated cable tray for indoor applications in dry environments. System height 60 mm. Provided with holes Ø5.8 mm at the tray end to be used for fixation of joints.

Material: Steel, pre-galvanized, powder-coated white.

W1/60-70	60/70/2000		165	7321677820115	<b>782011</b>
	60/70/3000		165	7321677820122	<b>782012</b>
W1/60-100	60/100/2000		185	7321677820122	<b>782012</b>
	60/100/3000		185	7321677820139	<b>782013</b>
W1/60-200	60/200/2000		335	7321677820139	<b>782013</b>
	60/200/3000		335	7321677820146	<b>782014</b>
W1/60-300	60/300/2000		440	7321677820146	<b>782014</b>
	60/300/3000		440	7321677820153	<b>782015</b>
W1/60-400	60/400/2000		540	7321677820153	<b>782015</b>
	60/400/3000		540	7321677820160	<b>782016</b>
W1/60-500	60/500/2000		755	7321677820160	<b>782016</b>
	60/500/3000		755	7321677820177	<b>782017</b>
W1/60-600	60/600/2000		870	7321677820177	<b>782017</b>
	60/600/3000		870	7321677820481	<b>782048</b>
W1/60-500 FS	60/500/2000		760	7321677820481	<b>782048</b>
W1/60-600 FS	60/600/2000		875	7321677820498	<b>782049</b>

PTCSU-0002



PTCSU-0002





# Steel cable trays

## Pre-galvanized white

### Corrosion class C2

#### Cable trays, perforated

Type	Dimensions A/B/C mm	 Weight kg/100 m	EAN code	Ref. No.
------	------------------------	--	----------	----------

#### Cable tray W3

Perforated cable tray for indoor applications in dry environments. System height 40 mm. Provided with holes Ø 5.8 mm at the tray end to be used for fixation of joints. Oval holes along the lateral side of the tray can be used for mounting of accessories.  
Material: Steel, pre-galvanized white.



PTCSU-0018

W3/40-50	40/50/3000	103	7321677375370	<b>737537</b>
W3/40-70	40/70/3000	120	7321677375387	<b>737538</b>
W3/40-100	40/100/3000	136	7321677375394	<b>737539</b>
W3/40-150	40/150/3000	170	7321677375400	<b>737540</b>
W3/40-200	40/200/3000	196	7321677375417	<b>737541</b>
W3/40-300	40/300/3000	316	7321677375424	<b>737542</b>
W3/40-400	40/400/3000	390	7321677375431	<b>737543</b>
W3/40-500	40/500/3000	590	7321677375448	<b>737544</b>
W3/40-600	40/600/3000	683	7321677375455	<b>737545</b>

Perforated cable tray for indoor applications in dry environments. System height 60 mm. Provided with holes Ø 5.8 mm at the tray end to be used for fixation of joints. Oval holes along the lateral side of the tray can be used for mounting of accessories.  
Material: Sheet steel, pre-galvanized white.



PTCSU-0018

W3/60-70	60/70/3000	150	7321677823062	<b>782306</b>
W3/60-100	60/100/3000	180	7321677823079	<b>782307</b>
W3/60-150	60/150/3000	200	7321677823086	<b>782308</b>
W3/60-200	60/200/3000	240	7321677823093	<b>782309</b>
W3/60-300	60/300/3000	337	7321677823109	<b>782310</b>
W3/60-400	60/400/3000	440	7321677823116	<b>782311</b>

#### Installation tray W4



Perforated installation tray for indoor applications in dry environments. To be used when leading cables down from a cable ladder to machine cabinets, etc. Provided with holes Ø 3.5 mm in the bottom segment of the tray for the clamping of cables with plate screws.



ODA736992-bis

W4-50	15/50/1960	57	7321677366330	<b>736633</b>
	15/50/3000	57	7321677872275	<b>787227</b>
W4-75	15/75/1960	76	3303437366341	<b>736634</b>
	15/75/3000	76	7321677872282	<b>787228</b>
W4-100	15/100/1960	93	3303437366358	<b>736635</b>
	15/100/3000	93	7321677872299	<b>787229</b>
W4-150	15/150/1960	125	7321677366361	<b>736636</b>
	15/150/3000	125	7321677872305	<b>787230</b>
W4-200	15/200/1960	195	3303437366372	<b>736637</b>
	15/200/3000	195	7321677872312	<b>787231</b>
W4-250	15/250/1960	228	3303437366389	<b>736638</b>
	15/250/3000	228	7321677872329	<b>787232</b>
W4-300	15/300/1960	238	7321677366392	<b>736639</b>
W4-400	15/400/1960	313	7321677366408	<b>736640</b>

#### Lighting trunking

Type	Dimensions A/B/C mm		Weight kg/100 m	EAN code	Ref. No.
<b>Lighting trunking W70-50, -70, -100, -200</b>					
Cable tray with bottom perforation for indoor applications in dry environments. System height 40 mm, length 3000 mm. Oval holes 9x5.8 mm on the lateral sides of the tray end can be used for fixation of joints. The oval hole pattern at the base of the tray can be used for mounting of lighting fixtures. On every 500 mm an oval hole is placed to easily guide fast connectors into the tray. Material: Steel, pre-galvanized white.					
 PTCSU0019	W70-50	40/50/3000	254	3606480756108	<b>CSU795217</b>
	W70-70	40/70/3000	274	3606480410390	<b>CSU794184</b>
	W70-100	40/100/3000	323	3606480410352	<b>CSU794185</b>
	W70-200	40/200/3000	487	3606480410376	<b>CSU794186</b>

#### Covers

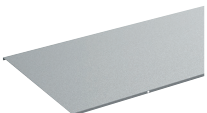
			Weight kg/100 pcs		
<b>Cover W5</b>					
Cover to be used to protect the cables inside the cable tray against damages, dust, liquids, UV-influence, etc. Material: Sheet steel, pre-galvanized white.					
 P140357	W5-70	10/71/2000	100	7321677290154	<b>729015</b>
	W5-100	10/101/2000	140	7321677290161	<b>729016</b>
	W5-150	10/151/2000	190	7321677341344	<b>734134</b>
	W5-200	10/201/2000	250	7321677290178	<b>729017</b>
	W5-300	10/301/2000	360	7321677290185	<b>729018</b>
	W5-400	10/401/2000	680	7321677290192	<b>729019</b>
	W5-500	10/501/2000	840	7321677290208	<b>729020</b>
	W5-600	10/601/2000	700	7321677290215	<b>729021</b>

<b>Cover clamp W62</b>					
Cover clamp to be used for the fixing of covers on cable trays W1/W3 as well as on lighting trunking W70. Material: Stainless steel 304.					
 P146808	W62	-/15/10.5	0.8	7321677301867	<b>730186</b>

#### Dividers

<b>Dividing strip 39</b>					
Dividing strip to be used to separate power and data communication cables inside a W1/W3 cable tray or W70 lighting trunking. Mounted with Support band 6. Material: Steel, pre-galvanized white.					
 P140356	39/24	24/24/1750	46	7321677179503	<b>717950</b>
	39/55	55/24/1750	73	7321677257867	<b>725786</b>

<b>Insert piece W39</b>					
Insert piece to be used to join Dividing strips 39/24 in cable tray W1/W3 and lighting trunking W70. The Insert piece can be positioned on Support bracket/joint W7/40 to ensure a continuous separation of cables inside the cable tray. Material: PP, natural coloured.					
 P140044	W39	37/-/330	3	7321677168248	<b>716824</b>

<b>Insert piece W39/55</b>					
Insert piece to be used to join Dividing strips 39/55 in Cable trays W1/60 or W3/60. The insert piece can be positioned on Support bracket/joint W7/60 to ensure a continuous separation of cables inside the cable tray. Material: Sheet steel, pre-galvanized white.					
 782289	W39/55	54/4.4/400	19	7321677868735	<b>786873</b>

### Dividers

Type	Dimensions A/B/C mm	Weight kg/100 pcs	EAN code	Ref. No.
<b>Support band W6</b>				
Support band to be placed inside cable trays to fix the lateral position of one or several Dividing strips W39. The holes in the support band and the locking pins in Dividing strip W39 enable an adjustment of the lateral positioning of the dividing strip with an interval of 25 mm. Material: Sheet steel, pre-galvanized.				
W6-70	-18/67	1.0	7321677188284	<b>718828</b>
W6-100	-18/97	1.4	7321677188291	<b>718829</b>
W6-200	-18/197	2.8	7321677188307	<b>718830</b>
W6-300	-18/297	4.3	7321677188314	<b>718831</b>
W6-400	-18/397	5.7	7321677188321	<b>718832</b>
W6-500	-18/497	7.2	7321677188338	<b>718833</b>
W6-600	-18/597	8.6	7321677188345	<b>718834</b>

### Joints

<b>Support bracket/joint W7</b>				
To be used as a support bracket or joint for cable tray W1/40, W3/40 and for lighting trunking W70. When joining cable tray W1/40 FS (reinforced), side joint W49/40 must be used. Material: Sheet steel, pre-galvanized white.				
W7/40-70	38/68/200	16	7321677290468	<b>729046</b>
W7/40-100	38/98/200	25	7321677290475	<b>729047</b>
W7/40-200	38/198/200	43	7321677290482	<b>729048</b>
W7/40-300	38/297/300	110	7321677290499	<b>729049</b>
W7/40-400	38/397/300	140	7321677290505	<b>729050</b>
W7/40-500	38/498/300	170	7321677290512	<b>729051</b>
W7/40-600	38/598/300	200	7321677290529	<b>729052</b>
<b>Support bracket/joint W7</b>				
To be used as a support bracket or joint for cable tray W1/60, W3/60. When joining cable tray W1/60 FS (reinforced), side joint W49/60 must be used. Material: Sheet steel, pre-galvanized white.				
W7/60-70	58/68/152	22	7321677823185	<b>782318</b>
W7/60-100	58/98/200	33	7321677823192	<b>782319</b>
W7/60-150	58/148/200	41	7321677823208	<b>782320</b>
W7/60-200	58/198/200	49	7321677823215	<b>782321</b>
W7/60-300	58/297/300	122	7321677823222	<b>782322</b>
W7/60-400	58/397/300	152	7321677823239	<b>782323</b>
W7/60-500	58/498/300	180	7321677823246	<b>782324</b>
W7/60-600	58/598/300	210	7321677823253	<b>782325</b>
<b>Side joint W49</b>				
Side joint to be used for straight joining of cable trays W1 and W3. Material: Sheet steel, pre-galvanized white.				
W49/40	37.5/-/300	17	7321677868384	<b>786838</b>
W49/60	58/-/300	27	7321677823307	<b>782330</b>
<b>Joint W2</b>				
Side joint to be used for straight joining of installation tray W4. Material: Sheet steel, pre-galvanized white.				
W2	15/25/200	8	7321677885749	<b>788574</b>

# Steel cable trays

Pre-galvanized white

Corrosion class C2

## Joins

Type	Dimensions A/B/C mm		Weight kg/100 pcs	EAN code	Ref. No.
<b>T-joint W9</b>					
T-joint to be used to construct T-sections or X-sections. Also used for oblique branches. The ref. number includes two pieces of T-joints and Screw set W38P. Material: Sheet steel, pre-galvanized white.					
W9/40	40/72.5/20		6	7321677290949	<b>729094</b>
W9/60	60/72.5/20		5	7321677822188	<b>782218</b>
<b>T-joint W29</b>					
T-joint to be used to construct T-junctions or X-junctions. Easy push-in assembly. Locks into the tray via locking flap. To be suspended over the lateral side of the tray and locked in a suitable way. Material: Sheet steel, pre-galvanized white.					
W29/40-70	38/67/68		8	7321677249428	<b>724942</b>
W29/40-100	38/67/98		12	7321677249435	<b>724943</b>
W29/40-200	38/67/198		21	7321677249442	<b>724944</b>
W29/40-300	38/67/301		30	7321677249459	<b>724945</b>
W29/40-400	38/67/401		40	7321677249466	<b>724946</b>
W29/40-500	38/67/501		50	7321677249473	<b>724947</b>
W29/40-600	38/67/601		59	7321677249480	<b>724948</b>
T-joint to be used to construct T-junctions or X-junctions. Easy push-in assembly. Locks into the tray via locking flap. To be suspended over the lateral side of the tray and locked in a suitable way. Material: Sheet steel, pre-galvanized white.					
W29/60-70	58/67/68		22	7321677831852	<b>783185</b>
W29/60-100	58/67/98		27	7321677831869	<b>783186</b>
W29/60-200	58/67/198		37	7321677831876	<b>783187</b>
W29/60-300	58/67/298		47	7321677831883	<b>783188</b>
W29/60-400	58/67/398		57	7321677831890	<b>783189</b>
W29/60-500	58/67/498		67	7321677831906	<b>783190</b>
W29/60-600	58/67/598		77	7321677831913	<b>783191</b>

718205



782217



790986



783180



### Bends

	Type	Dimensions A/B/C mm		Weight kg/100 pcs	EAN code	Ref. No.
	<b>90° bend W10</b>					
	Horizontal 90° bend to be used for cable trays W1/40 and W3/40. Push-in assembly. Material: Sheet steel, pre-galvanized white.					
	W10/40-50 (flat)	38/183/183		14.9	3606480994944	<b>CSU795380</b>
	W10/40-70	38/167/167		38	7321677292011	<b>729201</b>
	W10/40-100	38/197/197		51	7321677291335	<b>729133</b>
	W10/40-200	38/297/297		108	7321677291342	<b>729134</b>
	W10/40-300	38/397/397		185	7321677291359	<b>729135</b>
	W10/40-400	38/497/497		281	7321677291366	<b>729136</b>
	W10/40-500	38/597/597		400	7321677291373	<b>729137</b>
	W10/40-600	38/697/697		540	7321677291380	<b>729138</b>
	Horizontal 90° bend to be used for cable trays W1/60 and W3/60. Push-in assembly. Material: Sheet steel, pre-galvanized white.					
	W10/60-70	58/167/167		43	7321677824083	<b>782408</b>
	W10/60-100	58/197/197		55	7321677824090	<b>782409</b>
	W10/60-150	58/247/247		85	7321677824106	<b>782410</b>
	W10/60-200	58/297/297		117	7321677824113	<b>782411</b>
	W10/60-300	58/397/397		196	7321677824120	<b>782412</b>
	W10/60-400	58/497/497		295	7321677824137	<b>782413</b>
	W10/60-500	58/597/597		413	7321677824144	<b>782414</b>
	W10/60-600	58/697/697		551	7321677824151	<b>782415</b>
	W10/60-500 FS	58/597/597		343	7321677871889	<b>787188</b>
	W10/60-600 FS	58/697/697		465	7321677871896	<b>787189</b>
	<b>Adjustable bend W10S</b>					
	Adjustable bend to be used for horizontal angling from 105° to 165° in steps of 7.5°. Push-in assembly. Material: Sheet steel, pre-galvanized white.					
	W10S/40-70	38/67/67		10	7321677291038	<b>729103</b>
	W10S/40-100	38/97/97		13	7321677291045	<b>729104</b>
	W10S/40-200	38/197/197		40	7321677291052	<b>729105</b>
	W10S/40-300	38/297/297		75	7321677291069	<b>729106</b>
	W10S/40-400	38/397/397		125	7321677291076	<b>729107</b>
	W10S/40-500	38/497/497		270	7321677291083	<b>729108</b>
	W10S/40-600	38/597/597		380	7321677291090	<b>729109</b>
	Adjustable bend to be used for horizontal angling from 105° to 165° in steps of 7.5°. Push-in assembly. Material: Sheet steel, pre-galvanized white.					
	W10S/60-70	58/67/67		17	7321677824717	<b>782471</b>
	W10S/60-100	58/97/97		23	7321677824724	<b>782472</b>
	W10S/60-150	58/147/147		37	7321677824731	<b>782473</b>
	W10S/60-200	58/197/197		53	7321677824748	<b>782474</b>
	W10S/60-300	58/297/297		97	7321677824755	<b>782475</b>
	W10S/60-400	58/397/397		156	7321677824762	<b>782476</b>
	W10S/60-500	58/497/497		292	7321677824779	<b>782477</b>
	W10S/60-600	58/597/597		406	7321677824786	<b>782478</b>
	<b>90° bend W4</b>					
	Horizontal 90° bend to be used for cable tray W4. To be mounted on the outside of the tray and attached in the bottom segment with screw set W34. Material: Sheet steel, pre-galvanized white.					
	W4-50	16/52/-		10	7321677841134	<b>784113</b>
	W4-75	16/77/-		15	7321677841141	<b>784114</b>
	W4-100	16/102/-		22	7321677841158	<b>784115</b>
	W4-150	16/152/-		37	7321677841165	<b>784116</b>
	W4-200	16/202/-		55	7321677841172	<b>784117</b>
	W4-250	16/252/-		77	7321677841189	<b>784118</b>
	W4-300	16/302/-		102	7321677841196	<b>784119</b>
	W4-400	16/402/-		161	7321677841202	<b>784120</b>



#### Junctions

Type	Dimensions A/B/C mm		Weight kg/100 pcs	EAN code	Ref. No.
<b>T-junction W12</b>					
T-junction to be used for 90° horizontal junction of cable trays W1/40 and W3/40. Push-in assembly. Material: Sheet steel, pre-galvanized white.					
W12/40-50 (flat)	-/185/248		21.2	3606480994982	<b>CSU795384</b>
W12/40-70	38/267/167		49	7321677291397	<b>729139</b>
W12/40-100	38/297/197		64	7321677291403	<b>729140</b>
W12/40-200	38/397/297		128	7321677291410	<b>729141</b>
W12/40-300	38/497/397		212	7321677291427	<b>729142</b>
W12/40-400	38/597/497		314	7321677291434	<b>729143</b>
W12/40-500	38/697/597		438	7321677291441	<b>729144</b>
W12/40-600	38/797/697		580	7321677291458	<b>729145</b>
<b>T-junction to be used for 90° horizontal junction of cable trays W1/60 and W3/60. Push-in assembly. Material: Sheet steel, pre-galvanized white.</b>					
W12/60-70	58/267/167		54	7321677824243	<b>782424</b>
W12/60-100	58/297/197		70	7321677824250	<b>782425</b>
W12/60-150	58/347/247		99	7321677824267	<b>782426</b>
W12/60-200	58/397/297		133	7321677824274	<b>782427</b>
W12/60-300	58/497/397		217	7321677824281	<b>782428</b>
W12/60-400	58/597/497		320	7321677824298	<b>782429</b>
W12/60-500	58/697/597		443	7321677824304	<b>782430</b>
W12/60-600	58/797/697		585	7321677824311	<b>782431</b>
W12/60-500 FS	58/697/597		337	7321677871926	<b>787192</b>
W12/60-600 FS	58/797/697		454	7321677871933	<b>787193</b>
<b>X-junction W13</b>					
X-junction to be used for 90° horizontal junction of cable trays W1/40 and W3/40. Push-in assembly. Material: Sheet steel, pre-galvanized white.					
W13/40-50 (flat)	-/248/248		24.9	3606480995026	<b>CSU795388</b>
W13/40-70	38/267/267		64	7321677291465	<b>729146</b>
W13/40-100	38/297/297		80	7321677291472	<b>729147</b>
W13/40-200	38/397/397		150	7321677291489	<b>729148</b>
W13/40-300	38/497/497		240	7321677291496	<b>729149</b>
W13/40-400	38/597/597		350	7321677291502	<b>729150</b>
W13/40-500	38/697/697		480	7321677291519	<b>729151</b>
W13/40-600	38/797/797		630	7321677291526	<b>729152</b>
<b>X-junction to be used for 90° horizontal junction of cable trays W1/60 and W3/60. Push-in assembly. Material: Sheet steel, pre-galvanized white.</b>					
W13/60-70	58/268/268		62	7321677824403	<b>782440</b>
W13/60-100	58/298/298		78	7321677824410	<b>782441</b>
W13/60-150	58/348/348		110	7321677824427	<b>782442</b>
W13/60-200	58/398/398		146	7321677824434	<b>782443</b>
W13/60-300	58/498/498		234	7321677824441	<b>782444</b>
W13/60-400	58/598/598		342	7321677824458	<b>782445</b>
W13/60-500	58/698/698		469	7321677824465	<b>782446</b>
W13/60-600	58/798/798		616	7321677824472	<b>782447</b>
W13/60-500 FS	58/698/698		328	7321677871964	<b>787196</b>
W13/60-600 FS	58/798/798		441	7321677871971	<b>787197</b>
<b>Cover plate W16</b>					
Cover plate to be used to level out the differences in level between cable tray and junctions, such as 90° bends, T- and X-junctions. To be mounted under the junctions. Material: Sheet steel, pre-galvanized white.					
W16-70	1.5/70/70		6	7321677291540	<b>729154</b>
W16-100	1.5/100/100		12	7321677291557	<b>729155</b>
W16-200	1.5/200/200		48	7321677291564	<b>729156</b>
W16-300	1.5/300/300		108	7321677291571	<b>729157</b>
W16-400	1.5/400/400		192	7321677291588	<b>729158</b>

#### Vertical riser

ODAY23228



Type	Dimensions A/B/C mm	Weight kg/100 pcs	EAN code	Ref. No.
<b>Vertical riser W11</b>				
Vertical riser to be used as internal or external riser for cable tray W1/40 and W3/40. The riser is delivered flat and can be bent to the desired angle up to 90°. Push-in assembly. Material: Sheet steel, pre-galvanized white.				
W11/40-50	-38/48/150	8	7321677341016	<b>734101</b>
W11/40-70	-68/150	10	7321677291267	<b>729126</b>
W11/40-100	-98/150	12	7321677291274	<b>729127</b>
W11/40-200	-198/200	28	7321677291281	<b>729128</b>
W11/40-300	-298/200	39	7321677291298	<b>729129</b>
W11/40-400	-398/200	50	7321677291304	<b>729130</b>
W11/40-500	-498/200	61	7321677291311	<b>729131</b>
W11/40-600	-598/200	73	7321677291328	<b>729132</b>

782279



Vertical riser to be used as internal or external riser for cable tray W1/60 and W3/60. The riser is delivered flat and can be bent to the desired angle up to 90°. Push-in assembly. Material: Sheet steel, pre-galvanized white.				
W11/60-70	-67/150	12	7321677825936	<b>782593</b>
W11/60-100	-97/150	15	7321677825943	<b>782594</b>
W11/60-150	-147/150	19	7321677825950	<b>782595</b>
W11/60-200	-197/200	31	7321677825967	<b>782596</b>
W11/60-300	-297/200	42	7321677825974	<b>782597</b>
W11/60-600	-397/200	53	7321677825981	<b>782598</b>
W11/60-500	-497/200	64	7321677825998	<b>782599</b>
W11/60-600	-597/200	75	7321677826001	<b>782600</b>

784083

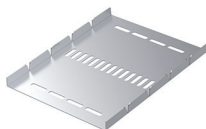

<b>Vertical riser W4</b>				
Vertical riser suitable for installation tray W4. To be used as internal or external riser. The riser is delivered flat and can be bent to the desired angle up to 90°. Push-in assembly. Material: Sheet steel, pre-galvanized white.				
W4-50	16/52/250	15	7321677841059	<b>784105</b>
W4-75	16/77/250	19	7321677841066	<b>784106</b>
W4-100	16/102/250	24	7321677841073	<b>784107</b>
W4-150	16/152/250	33	7321677841080	<b>784108</b>
W4-200	16/202/250	42	7321677841097	<b>784109</b>
W4-250	16/252/250	58	7321677841103	<b>784110</b>
W4-300	16/302/250	68	7321677841110	<b>784111</b>
W4-400	16/402/250	77	7321677841127	<b>784112</b>

### Reducers

PTCSU-0028



Type	Dimensions A/B/C mm	Weight kg/100 pcs	EAN code	Ref. No.
<b>Reducer W28/40</b>				
Reducer for cable tray W1/W3, system height 40. To be used together with side joint W49 in side transitions. In centered transitions only two reducers W28 are necessary. Material: Sheet steel, pre-galvanized white.				
W28/40-50	37.5/50/200	15	7321677935796	<b>793579</b>
W28/40-100	37.5/100/200	17	7321677874385	<b>787438</b>
W28/40-150	37.5/150/200	20	7321677935802	<b>793580</b>
W28/40-200	37.5/200/200	23	7321677874392	<b>787439</b>
W28/40-250	37.5/250/200	26	7321677935819	<b>793581</b>
W28/40-300	37.5/300/200	29	7321677935826	<b>793582</b>
W28/40-350	37.5/350/200	32	7321677935833	<b>793583</b>
W28/40-400	37.5/400/200	36	7321677935840	<b>793584</b>
W28/40-450	37.5/450/200	39	7321677935857	<b>793585</b>
W28/40-500	37.5/500/200	41	7321677935864	<b>793586</b>

787443



<b>Reducer W28/60</b>				
Reducer for cable tray W1/W3, system height 60. To be used together with side joint W49 in side transitions. In centered transitions only two reducers W28 are necessary. Material: Sheet steel, pre-galvanized white.				
W28/60-50	57.5/50/200	22	7321677936151	<b>793615</b>
W28/60-100	57.5/100/200	27	7321677874446	<b>787444</b>
W28/60-150	57.5/150/200	31	7321677936168	<b>793616</b>
W28/60-200	57.5/200/200	36	7321677874453	<b>787445</b>
W28/60-250	57.5/250/200	40	7321677936175	<b>793617</b>
W28/60-300	57.5/300/200	45	7321677936182	<b>793618</b>
W28/60-350	57.5/350/200	49	7321677936199	<b>793619</b>
W28/60-400	57.5/400/200	54	7321677936205	<b>793620</b>
W28/60-450	57.5/450/200	58	7321677936212	<b>793621</b>
W28/60-500	57.5/500/200	63	7321677936229	<b>793622</b>

### End covers

731732



<b>End cover W45</b>				
End cover to be mounted at the ends of cable trays W1/40 and W3/40 and of lighting trunking W70. Provided with oval holes 6x55 mm on the sides. Push-in assembly. Material: Sheet steel, pre-galvanized white.				
W45/40-70	38/100/68	8	7321677291779	<b>729177</b>
W45/40-100	38/100/98	9	7321677291786	<b>729178</b>
W45/40-200	38/100/198	12	7321677291793	<b>729179</b>
W45/40-300	38/100/298	15	7321677291809	<b>729180</b>
W45/40-400	38/100/398	18	7321677291816	<b>729181</b>
W45/40-500	38/100/498	21	7321677291823	<b>729182</b>
W45/40-600	38/100/598	24	7321677291830	<b>729183</b>

PTCSU-0027



End cover to be mounted at the ends of cable trays W1/60 and W3/60. Provided with oval holes 6x55 mm on the sides. Push-in assembly. Material: Sheet steel, pre-galvanized white.				
W45/60-70	58/100/68	12	7321677867714	<b>786771</b>
W45/60-100	58/100/98	13	7321677867721	<b>786772</b>
W45/60-200	58/100/198	18	7321677867738	<b>786773</b>
W45/60-300	58/100/298	23	7321677867745	<b>786774</b>
W45/60-600	58/100/398	28	7321677867752	<b>786775</b>
W45/60-500	58/100/498	34	7321677867769	<b>786776</b>
W45/60-600	58/100/598	39	7321677867776	<b>786777</b>

#### Box plates

Type	Dimensions A/B/C mm		Weight kg/100 pcs	EAN code	Ref. No.
<b>Junction box plate W24</b>					
Junction box plate, with or without perforated hole pattern. To be used for the installation of junction boxes, light fittings, etc., in cable trays W1/40 and W3/40 and in lighting trunking W70. Material: Sheet steel, pre-galvanized white.					
W24/40	161/43/200		27	7321677291847	<b>729184</b>
W24/40 non-perforated	161/43/200		31	7321677342112	<b>734211</b>
<b>Junction box plate W24/60</b>					
Junction box plate, with perforated hole pattern. To be used for the installation of junction boxes, light fittings, etc., in cable trays W1/60 and W3/60. Material: Sheet steel, pre-galvanized white.					
W24/60	179/43/200		34	7321677826599	<b>782659</b>
<b>Earth clamp W79</b>					
Earth clamp to be used when protective earthing of the junction box plate is required. Material: Steel, electro-galvanized.					
W79	Screw M4/-/4.5		0.2	7321677166404	<b>716640</b>

#### Outlet and junction box sets

<b>Junction box set</b>					
Junction box set including junction box plate W24/40 and a pre-mounted junction box UP, IP-class IP65. Material: Sheet steel, pre-galvanized.					
Junction box set	161/50/200		39	7321677319640	<b>731964</b>
<b>Outlet set</b>					
Outlet set including junction box plate W24/40 and a pre-mounted outlet, 2-way. Material: Sheet steel, pre-galvanized.					
Outlet set	161/53/200		36	7321677342280	<b>734228</b>

#### Luminaire brackets

<b>Luminaire bracket W25</b>					
Luminaire bracket to be used for assembly of lighting fixtures under Cable trays W1/40 and W3/40 or Lighting trunking W70. Material: Sheet steel, pre-galvanized white.					
W25/40-70	62/30/72		7	7321677291854	<b>729185</b>
W25/40-100	62/30/101		8	7321677291861	<b>729186</b>
W25/40-200	62/30/201		11	7321677291878	<b>729187</b>
W25/40-300	62/30/301		19	7321677291885	<b>729188</b>
W25/40-400	62/30/401		23	7321677291892	<b>729189</b>
W25/40-500	62/30/501		27	7321677291908	<b>729190</b>
W25/40-600	62/30/601		31	7321677291915	<b>729191</b>
<b>Luminaire bracket W25/60</b>					
Luminaire bracket to be used for assembly of lighting fixtures under Cable trays W1/60 and W3/60. Material: Sheet steel, pre-galvanized white.					
W25/60-70	82/30/72		7.7	7321677826148	<b>782614</b>
W25/60-100	82/30/101		8.6	7321677826155	<b>782615</b>
W25/60-200	82/30/201		14	7321677826162	<b>782616</b>
W25/60-300	82/30/301		18	7321677826179	<b>782617</b>
W25/60-400	82/30/401		23	7321677826186	<b>782618</b>
W25/60-500	82/30/501		27	7321677826193	<b>782619</b>
W25/60-600	82/30/601		32	7321677826209	<b>782620</b>
<b>Luminaire bracket W50</b>					
Luminaire bracket to be used to mount lighting fittings between two parallel Cable trays W1/W3 or Lighting trunking W70. Dimension A (* height) is specified when ordering and is depending on the height of the lighting fitting. The weight ** is calculated for a bracket with a height of 100 mm. Material: Sheet steel, pre-galvanized white.					
W50	* /30/250		25**	7321677207855	<b>720785</b>
<b>Luminaire bracket W35</b>					
Luminaire bracket to be used to mount centralized lighting fixtures under Lighting trunking W70. Material: Sheet steel, pre-galvanized.					
W35	15/30/70		3	7321677156504	<b>715650</b>

## Luminaire brackets

Type	Dimensions A/B/C mm		Weight kg/100 pcs	EAN code	Ref. No.
<b>Luminaire bracket W55</b>					
Luminaire bracket to be used to mount lighting fixtures under Lighting trunking W70. Material: Sheet steel, pre-galvanized.					
W55	16/12/42		8	7321677209798	<b>720979</b>

PTCSU-0041



## Integrated ceiling parts

<b>Shade ledge W26</b>					
Shade ledge to be used as a support for ceilings mounted between cable trays with system height 40 mm. Suspended over the lateral side of the cable tray. Also suitable for Lighting trunking W70. Material: Sheet steel, pre-galvanized white.					
W26/40	51/41/2000		154	7321677291922	<b>729192</b>

717990



Shade ledge to be used as a support for ceilings mounted between cable trays with system height 60 mm. Suspended over the lateral side of the cable tray. Material: Sheet steel, pre-galvanized white.					
W26/60	61/42/2000		185	7321677826612	<b>782661</b>

PTCSU-0034



<b>Ceiling support W27</b>					
Integrated support channel to be used as a support for false ceilings mounted between cable trays with system height 40 mm. Suspended over the lateral side of the cable tray. Also suitable for Lighting trunking W70. Material: Sheet steel, pre-galvanized white.					
W27/40	41/25/2000		130	7321677291939	<b>729193</b>

PTCSU-0035



Integrated support channel to be used as a support for false ceilings mounted between cable trays with system height 60 mm. Suspended over the lateral side of the cable tray. Material: Sheet steel, pre-galvanized white.					
W27/60	60/25/2000		160	7321677826629	<b>782662</b>

PTCSU-0003



<b>Locking clamp W77</b>					
Locking clamp to be used when pendant rail W32 is mounted between two parallel lighting trunking W70 or cable trays W1/W3 for additional stability. Material: Sheet steel, pre-galvanized white.					
W77	12/40/47		1.5	7321677290604	<b>729060</b>

PTCSU-0004





## Screws, bolts and nuts

Type	Dimensions A/B/C mm		Weight kg/100 pcs	EAN code	Ref. No.
<b>Screw set W34</b>					
Screw set to be used for mounting of Cable tray W3 onto Cantilever arm 50, Locking clamp W77 and Angle bracket W8 onto Pendant rail W32, Junction box plate W24 onto W3 Cable tray or Lighting trunking W70, as well as for assembly of Angle bracket W8 (light fitting bracket) and for joining of W4 Installation trays. Set including screw MSCS 6x12 and nut M6MF 6. Material: Steel, electro-galvanized.					
W34	10/10/16		0.8	7321677184736	718473
<b>Screw set W36</b>					
Screw set including bolt and nut M8 to be used for the mounting of single Pendant attachment W21 or Tube pendant attachment W73 on Support bracket/joint W7. Material: Steel, electro-galvanized.					
W36	M8		1.2	7321677156467	715646
<b>Screw set W36C</b>					
Screw set including bolt with slotted screw head and nut M8. To be used for the mounting of single Pendant attachment W21 or Tube pendant attachment W73 on Support bracket/joint W7. Material: Steel, electro-galvanized.					
W36C	M8		1.8	7321677835003	783500
<b>Screw set W37</b>					
Screw set including bolt MVBF 8x35 and nut M6MF 8, to be used for assembly of Pendant attachment W21 and Ceiling attachment W31 with Pendant rail W32, and for the joining of Pendant rail W32. Material: Steel, electro-galvanized.					
W37	M8		2.8	7321677167999	716799
<b>Screw set W38P C4 White</b>					
Screw set including screw (with screw head lacquered white) and nut, to be used for the mounting of joints, bends, junctions, shade ledge W26 and integrated ceiling support channel W27. The patented screw set pierces through painted surfaces securing potential balancing. N.B. The joints must be unpainted. Material: Steel. Corrosion class: C4, white.					
W38P	–		0.4	7321677822164	782216
<b>Screw W40</b>					
Screw (RXS ST 5.5x13-H) to be used for the locking of T-joint W29 in open junctions. Material: Steel, electro-galvanized.					
W40	–		0.3	7321677218684	721868
<b>T-bolt 26U</b>					
T-bolt to be used for mounting with all vertical pieces (except Vertical piece 2) and with Pendant/fixing rail 24/48. Material: Steel, electro-galvanized.					
26U M8x30	50/44/18		6.8	3606489579760	CSU795594
26U M10x30	50/44/18		6.8	3606489579708	CSU795588
<b>Locking plug W41</b>					
Locking plug to be used for quick locking of joints, bends and branches in cable trays and lighting trunking. Material: PP+GF10.					
W41	Ø14/10.5		0.1	7321677186457	718645

#### Threaded rods

Type	Dimensions A/B/C mm		Weight kg/100 pcs	EAN code	Ref. No.
<b>Threaded rod W76</b>					
Threaded rod M6 to be used for light-duty cable tray W1/W3 and lighting trunking W70 suspensions. Material: Steel, electro-galvanized.					
W76 M6	1000/6/6		18	7321677840618	<b>784061</b>
W76 M6	2000/6/6		36	7321677929344	<b>792934</b>
W76 M6	3000/6/6		54	7321677929351	<b>792935</b>
<b>Threaded rod M8 to be used to suspend cable tray W1/W3 and lighting trunking W70 installations.</b> Material: Steel, electro-galvanized.					
W76 M8	1000/8/8		32	7321677250790	<b>725079</b>
<b>Threaded rod M10 to be used to suspend cable tray W1/W3 and lighting trunking W70 installations.</b> Material: Steel, electro-galvanized white.					
W76 M10	2000/10/10		100	7321677290611	<b>729061</b>
W76 M10	3000/10/10		150	7321677290628	<b>729062</b>
<b>Joint nut M6, M8, M10</b>					
Joint nut to be used to connect two lengths of threaded rods W76. Material: Steel, electro-galvanized.					
Joint nut M6	30/11.5/10		1.2	7321677840632	<b>784063</b>
Joint nut M8	40/15/13		5.0	7321677250837	<b>725083</b>
Joint nut M10	40/18.5/16		7.2	7321677248063	<b>724806</b>
<b>Thread lock B50</b>					
Thread lock M8 and M10 to be used to connect two lengths of threaded rods. Provides a quick and screw-less height adjustment of the threaded rod. Material: Steel, electro-galvanized.					
B50/M8	10/20/35		1	7332227014564	<b>1149456</b>
B50/M10	12/24/35		2	7332227014663	<b>1149466</b>
<b>Flange nut M6</b>					
Flange nut to be used to mount support brackets and ceiling brackets onto threaded rods W76. Material: Steel, electro-galvanized.					
Flange nut M6	M6		0.4	7321677840625	<b>784062</b>
<b>Flange nut B43</b>					
Flange nut to be mounted onto Threaded rod W76 in order to lock it to the Support hook and the Ceiling fittings. Package of 50 pcs. Material: Steel, electro-galvanized.					
B43/M8	17/17/8		0.4/bag	7321677888474	<b>1149405</b>
B43/M10	20/20/15		0.56/bag	7332227014649	<b>1149464</b>
<b>Pendant attachment W73</b>					
Tube pendant attachment to be used for mounting of threaded rod W76 M6/M10 in ceiling and cable tray W1/W3 and lighting trunking W70/71. Provides a quick and screw-less height adjustment of the threaded rod. Material: Sheet steel, pre-galvanized white.					
W73 M6	135/26/56		7	7321677912070	<b>791207</b>
W73 M10	135/26/56		7	7321677290550	<b>729055</b>

#### Ogebe fixings

716474



Type	Dimensions A/B/C mm	Weight kg/100 pcs	EAN code	Ref. No.
<b>Ogebe fixings</b>				
Ogebe fixing type E to be used for mounting in 0.7-0.9 mm sheeting or board material. Examples are hole straps, pendants, ducts, trays and piping. Material: Steel, elctro-galvanized.				
Type E	40/25/48	4.8	7321677164745	<b>716474</b>

#### Brackets

PTCSU-0037



<b>Support bracket W1940</b>				
Support bracket to be used for invisible installation of cable trays W1/40 and W3/40. Material: Sheet steel, pre-galvanized white.				
W1940-100	36/65/90	11	7321677290413	<b>729041</b>
W1940-200	36/65/190	22	7321677290420	<b>729042</b>
W1940-300	36/65/289	50	7321677290437	<b>729043</b>
W1940-400	36/65/389	68	7321677290444	<b>729044</b>
W1940-500	36/65/489	91	7321677837533	<b>783753</b>
W1940-600	36/65/589	110	7321677837540	<b>783754</b>

PTCSU-0037



<b>Support bracket W1960</b>				
Support bracket to be used for invisible installation of cable trays W1/60 and W3/60. Material: Sheet steel, pre-galvanized white.				
W1960-100	56/65/89	19	7321677831661	<b>783166</b>
W1960-200	56/65/189	37	7321677831678	<b>783167</b>
W1960-300	56/65/289	58	7321677831685	<b>783168</b>
W1960-400	56/65/389	77	7321677831692	<b>783169</b>
W1960-500	56/65/489	96	7321677831708	<b>783170</b>
W1960-600	56/65/589	115	7321677831715	<b>783171</b>

PTCSU-0049



<b>Support bracket W20A</b>				
Support bracket to be used for invisible installation of lighting trunking W70/71, width 70 and 100 mm. The support bracket is snapped firmly into the trunking. The spring locking device facilitates easy vertical height adjustment. Suitable for threaded rod W76 M10. Material: Sheet steel, pre-galvanized white.				
W20A-70	145/75/66	15	7321677290277	<b>729027</b>
W20A-100	148/89/90	20	7321677290284	<b>729028</b>

#### Cantilever arms

Type	Dimensions A/B/C mm		Weight kg/100 pcs	EAN code	Ref. No.
<b>Cantilever arm 50i</b>					
Cantilever arm 50i to be used for lighter mountings on walls, vertical pieces or pendant/fixing rails. Material: Steel, pre-galvanized white.					
50i-100	80/43/150		19	7321677914166	<b>791416</b>
50i-200	85/43/250		29	7321677914173	<b>791417</b>
50i-300	110/43/350		46	7321677914180	<b>791418</b>
50i-400	115/44/450		83	7321677914197	<b>791419</b>
<b>Internal cantilever arm W17/40</b>					
Internal cantilever arm to be used for invisible mounting inside cable tray W1/40 and W3/40. Material: Sheet steel, pre-galvanized white.					
W17/40-100	140/55/119		16	7321677290291	<b>729029</b>
W17/40-200	140/55/219		35	7321677290307	<b>729030</b>
W17/40-300	165/75/319		80	7321677290314	<b>729031</b>
W17/40-400	165/75/419		100	7321677290321	<b>729032</b>
<b>Adjustable internal cantilever arm W1840</b>					
Adjustable internal cantilever arm to be used for invisible mounting inside cable trays W1/40 and W3/40. Adjustability 0-25 mm (W1840-100) and 0-50 mm (W1840-200-600). Material: Sheet steel, pre-galvanized white.					
W1840-100	160/60/88		36	7321677290338	<b>729033</b>
W1840-200	160/60/188		47	7321677290345	<b>729034</b>
W1840-300	185/60/289		120	7321677835911	<b>783591</b>
W1840-400	185/60/389		139	7321677835928	<b>783592</b>
W1840-500	185/60/489		156	7321677835935	<b>783593</b>
W1840-600	185/60/589		175	7321677835942	<b>783594</b>
<b>Adjustable internal cantilever arm W1860</b>					
Adjustable cantilever arm to be used for invisible mounting inside cable trays W1/60 and W3/60. Adjustability 0-25 mm (100 mm length) and 0-50 mm (other lengths). Material: Sheet steel, pre-galvanized white.					
W1860-100	160/60/89		47	7321677835041	<b>783504</b>
W1860-200	160/60/189		65	7321677835058	<b>783505</b>
W1860-300	185/60/289		123	7321677835065	<b>783506</b>
W1860-400	185/60/389		142	7321677835072	<b>783507</b>
W1860-500	185/60/489		161	7321677835089	<b>783508</b>
W1860-600	185/60/589		180	7321677835096	<b>783509</b>
<b>Pendant bracket 80</b>					
Pendant bracket W80 mounted under lighting trunking W70-50 and attached with screw set W36/W36C. Threaded rod W76 M6 is easily mounted in the spring clasp without bolts. Adjustable to ± 30 mm. Material: Sheet sheet steel, pre-galvanized white.					
W80 M6	160/35/76		5.4	3606480994906	<b>CSU795372</b>
<b>Pendant bracket W81</b>					
Pendant bracket W81 is mounted under lighting trunking W70-50 and is attached with screw set W37. Pendant rail W32 is mounted mounted using screw set W37. Adjustable to ± 18 mm. Material: Sheet steel, Zinkpox coated white.					
W81 M6	140/2/76		4.1	3606480994920	<b>CSU795378</b>
<b>Wire Bracket W70-50</b>					
Wire bracket for screwless fixation, central suspension of lighting trunking W70-50. Material: Steel, hot-dip galvanized.					
Wire bracket	70/52/58		2.2	3606480994883	<b>CSU795370</b>
<b>Back plate W30</b>					
Back plate to be used for wall installation of internal cantilever arms on porous walls, to reduce the surface pressure. Material: Sheet steel, pre-galvanized white.					
W30	135/3/135		42	7321677867936	<b>786793</b>

P198832



PTCSL-0005



782393



782393



P151350



P151351



P151349



PTCSL-0039



## Vertical pieces

Type	Dimensions A/B/C mm		Weight kg/100 pcs	EAN code	Ref. No.
<b>Pendant strip W33</b>					
Pendant strip to be used as a light-duty vertical ceiling suspension. The pendant strip is delivered in a straight length of 1 m, to be bent on site. Pendants longer than 1 m are joined by overlapping, using Screw set W36/W36C. Material: Sheet steel, pre-galvanized white.					
W33	1000/25/-		19	7321677290598	<b>729059</b>

721786



## Ceiling brackets

<b>Ceiling attachment W31</b>					
Ceiling attachment to be used for installations with Pendant rail W32. Material: Sheet steel, pre-galvanized white.					
W31	70/64/25		6.5	7321677290635	<b>729063</b>
<b>Ceiling bracket 5TPA</b>					
Ceiling bracket with telescopic function, to be used for mounting of various sizes of trapezoid plates. Including screw MVBF 8x16 and nut M6MF8. Breaking load: 150 kg without deformation. Material: Steel, pre-galvanized white.					
5TPA	50/76/79-118		14	7321677334865	<b>733486</b>

718816



P140348



## Pendant rails

<b>Pendant rail W32</b>					
Pendant rail to be installed in ceilings in combination with ceiling attachment W31 or Ogebe fixing type E. Material: Sheet steel, pre-galvanized white.					
W32	3000/20/20		180	7321677290581	<b>729058</b>
<b>Pendant attachment W21</b>					
Pendant attachment to be used in combination with pendant rail W32, support bracket/joint W7, etc. Material: Sheet steel, pre-galvanized white.					
W21	97/50/21		12	7321677290543	<b>729054</b>

PTCSU-0009



PTCSU-0010



## Angle brackets

<b>Angle bracket W8</b>					
Angle bracket to be mounted inside a cable tray W1/W3 for horizontal installation to the wall or vertical installation to the floor. Can also be mounted as a pendant bracket in the lighting trunking W70. Material: Sheet steel, pre-galvanized white.					
W8	80/38/45		6	7321677290666	<b>729066</b>
<b>Angle bracket W8S</b>					
Universal angle bracket to be used for various installations of pendant/fixing rail 24/34, support bracket, etc. Material: Sheet steel, pre-galvanized white.					
W8S	120/30/30		8	7321677268740	<b>726874</b>

PTCSU-0011



PTCSU-0012



## Accessories

<b>Strip fixing W44</b>					
Strip fixing to be used for easy fixation of cables in an unperforated cable tray W1/40 or W1/60. Material: PPE.					
W44	5.5/25/96		1	7321677184699	<b>718469</b>
<b>Protection strip W48</b>					
Protection strip to be used to protect cables from sharp edges when cutting the cable tray W1/W3 or lighting trunking W70. Material: Plastic.					
W48	10/6/720		6.1	7321677872114	<b>787211</b>
<b>Repair paint</b>					
Repair paint for the repair of minor damages of powder-coated products. Colour white RAL 9003, gloss 30. Spray bottle, 0.4 l.					
Repair paint, white	-		60	7321677397136	<b>739713</b>

P148804



PTCSU-0013



P148450





#### Cable trays, perforated

PTCSLU-0018



Type	Dimensions A/B/C mm		Weight kg/100 m	EAN code	Ref. No.
<b>Cable tray W3</b>					
Perforated cable tray for indoor or outdoor industrial applications. System height 40 mm. Provided with holes Ø 5.8 mm at the tray end to be used for fixation of joints. Oval holes along the lateral sides of the tray can be used for mounting of accessories. Material: Steel, hot-dip galvanized.					
W3/40-50	40/50/3000		110	7321677354009	<b>735400</b>
W3/40-70	40/70/3000		120	7321677354016	<b>735401</b>
W3/40-100	40/100/3000		156	7321677354023	<b>735402</b>
W3/40-150	40/150/3000		170	7321677354030	<b>735403</b>
W3/40-200	40/200/3000		220	7321677354047	<b>735404</b>
W3/40-300	40/300/3000		350	7321677354054	<b>735405</b>
W3/40-400	40/400/3000		453	7321677354061	<b>735406</b>
W3/40-500	40/500/3000		620	7321677354078	<b>735407</b>
W3/40-600	40/600/3000		723	7321677354085	<b>735408</b>

ODAT35982-915



Type	Dimensions A/B/C mm	Weight kg/100 m	EAN code	Ref. No.
<b>Installation tray W4</b>				
Perforated installation tray for indoor or outdoor industrial applications. To be used when leading cables down from a cable ladder to machine cabinets, etc. Provided with holes Ø 3.5 mm in the bottom segment of the tray for the clamping of cables with plate screws. Material: Steel, hot-dip galvanized.				
W4-50	15/50/1960	57	7321677366132	<b>736613</b>
	15/50/3000	57	7321677359776	<b>735977</b>
W4-75	15/75/1960	76	7321677366149	<b>736614</b>
	15/75/3000	76	7321677359783	<b>735978</b>
W4-100	15/100/1960	93	7321677366156	<b>736615</b>
	15/100/3000	93	7321677359790	<b>735979</b>
W4-150	15/150/1960	125	7321677366163	<b>736616</b>
	15/150/3000	125	7321677359806	<b>735980</b>
W4-200	15/200/1960	195	7321677366170	<b>736617</b>
	15/200/3000	195	7321677359813	<b>735981</b>
W4-250	15/250/1960	228	7321677366187	<b>736618</b>
	15/250/3000	228	7321677359820	<b>735982</b>
W4-300	15/300/1960	238	7321677366194	<b>736619</b>
W4-400	15/400/1960	313	7321677366200	<b>736620</b>

#### Lighting trunking

PTCSLU-0019



Type	Dimensions A/B/C mm	Weight kg/100 pcs	EAN code	Ref. No.
<b>Lighting trunking W70-50, -70, -100</b>				
Cable tray with bottom perforation for indoor applications in dry environments. System height 40 mm, length 3000 mm. Oval holes 9x5.8 mm on the lateral sides of the tray end can be used for fixation of joints. The oval hole pattern at the base of the tray can be used for mounting of lighting fixtures. On every 500 mm an oval hole is placed to easily guide fast connectors into the tray. Material: Steel, hot-dip galvanized.				
W70-50	40/50/3000	271	3606480756115	<b>CSU795218</b>
W70-70	40/70/3000	293	3606480464812	<b>CSU794528</b>
W70-100	40/100/3000	346	3606480464829	<b>CSU794529</b>



#### Covers

P140357

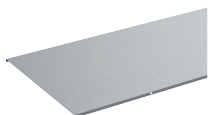

Type	Dimensions A/B/C mm	Weight kg/100 pcs	EAN code	Ref. No.
<b>Cover W5</b>				
Cover to be used to protect the cables inside the cable tray against damages, dust, liquids, UV-influence, etc. Material: Sheet steel, hot-dip galvanized.				
W5-70	10/71/2000	160	7321677322626	<b>732262</b>
W5-100	10/101/2000	210	7321677322633	<b>732263</b>
W5-150	10/151/2000	290	7321677322640	<b>732264</b>
W5-200	10/201/2000	370	7321677322657	<b>732265</b>
W5-300	10/301/2000	540	3606480535734	<b>732266</b>
W5-400	10/401/2000	710	7321677322671	<b>732267</b>
W5-500	10/501/2000	880	7321677322688	<b>732268</b>
W5-600	10/601/2000	1050	7321677322695	<b>732269</b>

P146808



Type	Dimensions A/B/C mm	Weight kg/100 pcs	EAN code	Ref. No.
<b>Cover clamp W62</b>				
Cover clamp to be used for the fixing of covers on cable trays W3 as well as on lighting trunking W70. Material: Stainless steel 304.				
W62	-/15/10.5	0.8	7321677301867	<b>730186</b>

#### Dividers

Type	Dimensions A/B/C mm	Weight kg/100 pcs	EAN code	Ref. No.
<b>Dividing strip 39</b>				
Dividing strip to be used to separate power and data communication cables inside a W3 cable tray or W70 lighting trunking. Material: Steel, hot-dip galvanized.				
P140356	39/24	24/24/1750	46	7321677317479 <b>731747</b>
	39/55	55/24/1750	73	7321677329830 <b>732983</b>
<b>Insert piece W39</b>				
Insert piece to be used to join Dividing strips 39/24 in cable tray W3 and lighting trunking W70. The Insert piece can be positioned on Support bracket/joint W7/40 to ensure a continuous separation of cables inside the cable tray. Material: Plastic, natural coloured.				
P140044	W39	37-/-/330	3	7321677168248 <b>716824</b>

#### Joints

<b>Joint W7/40</b>				
To be used as a joint for cable tray W3/40 and for lighting trunking W70. Material: Sheet steel, hot-dip galvanized.				
78212	W7/40-50	38/46/200	18	7321677912735 <b>791273</b>
	W7/40-70	38/66/200	21	7321677912742 <b>791274</b>
40-50, 40-70, 100, 40-150, 40-200	W7/40-100	38/96/200	26	7321677912759 <b>791275</b>
	W7/40-150	38/146/200	34	7321677912766 <b>791276</b>
	W7/40-200	38/196/200	42	7321677912773 <b>791277</b>
PTCSU-0006	W7/40-300	38/296/300	107	7321677912780 <b>791278</b>
40-300, 40-400	W7/40-400	38/396/300	137	7321677912797 <b>791279</b>
78212	W7/40-500	38/496/300	166	7321677912803 <b>791280</b>
40-500, 40-600	W7/40-600	38/596/300	195	7321677912810 <b>791281</b>
<b>Side joint W49</b>				
Side joint to be used for straight joining of cable tray W3/40. Material: Sheet steel, hot-dip galvanized.				
PTCSU-0021	W49/40	37.5-/-/300	17	7321677301911 <b>730191</b>
<b>Flexible coupler W3-40</b>				
Side joint to be used for straight joining of cable tray W3/40 and can also be used to create T-junctions, X-junctions, reducers (left, right and straight), horizontal bends, vertical risers and direct mounting suspension strips. Material: Sheet steel, zinc+ treatment				
PTCSU-0022	W3/40	36/2/300	17	3606480788987 <b>CSU795136</b>
<b>Joint W2</b>				
Side joint to be used for straight joining of installation tray W4. Material: Sheet steel, hot-dip galvanized.				
PTCSU-0023	W2	15/25/200	8	7321677885732 <b>788573</b>

### Bends

Type	Dimensions A/B/C mm	Weight kg/100 pcs	EAN code	Ref. No.
<b>T-joint W9</b>				
T-joint to be used to construct T-sections or X-sections. Also used for oblique branches. The ref. number includes two pieces of T-joints and Screw set W38P. Material: Sheet steel, hot-dip galvanized.				
W9/40	40/72.5/20	6	7321677346226	<b>734622</b>
<b>90° bend W10F</b>				
Horizontal 90° bend to be used for cable trays W3/40. Push-in assembly. Material: Sheet steel, hot-dip galvanized.				
W10/40-50 (flat)	38/183/183	14.9	3606480994951	<b>CSU795381</b>
W10F/40-50	38/47/119	14	7321677836604	<b>783660</b>
W10F/40-70	38/67/153	23	7321677836611	<b>783661</b>
W10F/40-100	38/97/204	39	7321677836628	<b>783662</b>
W10F/40-150	38/147/290	74	7321677836635	<b>783663</b>
W10F/40-200	38/197/375	119	7321677836642	<b>783664</b>
W10F/40-300	38/297/480	242	7321677836659	<b>783665</b>
W10F/40-400	38/397/580	353	7321677836666	<b>783666</b>
W10F/40-500	38/497/714	528	7321677836673	<b>783667</b>
W10F/40-600	38/597/814	685	7321677836680	<b>783668</b>
<b>Adjustable bend W10S</b>				
Adjustable bend to be used for horizontal angling from 105° to 165° in steps of 7.5°. Push-in assembly. Material: Sheet steel, hot-dip galvanized.				
W10S/40-50	38/47/47	9	7321677345915	<b>734591</b>
W10S/40-70	38/67/67	10	7321677345922	<b>734592</b>
W10S/40-100	38/97/97	13	7321677345939	<b>734593</b>
W10S/40-150	38/147/147	24	7321677345946	<b>734594</b>
W10S/40-200	38/197/197	40	7321677345953	<b>734595</b>
W10S/40-300	38/297/297	94	7321677345960	<b>734596</b>
W10S/40-400	38/397/397	156	7321677345977	<b>734597</b>
W10S/40-500	38/497/497	270	7321677345984	<b>734598</b>
W10S/40-600	38/597/597	380	7321677345991	<b>734599</b>
<b>90° bend W4</b>				
Horizontal 90° bend to be used for cable tray W4. To be mounted on the outside of the tray and attached in the bottom segment with screw set W38P. Material: Sheet steel, hot-dip galvanized.				
W4-50	16/52/-	10	7321677840816	<b>784081</b>
W4-75	16/77/-	15	7321677840823	<b>784082</b>
W4-100	16/102/-	22	7321677840830	<b>784083</b>
W4-150	16/152/-	37	7321677840847	<b>784084</b>
W4-200	16/202/-	55	7321677840854	<b>784085</b>
W4-250	16/252/-	77	7321677840861	<b>784086</b>
W4-300	16/302/-	102	7321677840878	<b>784087</b>
W4-400	16/402/-	161	7321677840885	<b>784088</b>
<b>T-junction W12F</b>				
T-junction to be used for 90° horizontal junction of cable trays W3/40. Push-in assembly. Material: Sheet steel, hot-dip galvanized.				
W12/40-50 (flat)	-/185/248	21.6	3606480994999	<b>CSU795385</b>
W12F/40-50	38/47/171	21	7321677836703	<b>783670</b>
W12F/40-70	38/67/219	29	7321677836710	<b>783671</b>
W12F/40-100	38/97/312	49	7321677836727	<b>783672</b>
W12F/40-150	38/147/432	89	7321677836734	<b>783673</b>
W12F/40-200	38/197/553	154	7321677836741	<b>783674</b>
W12F/40-300	38/297/662	300	7321677836758	<b>783675</b>
W12F/40-400	38/397/762	428	7321677836765	<b>783676</b>
W12F/40-500	38/497/932	640	7321677836772	<b>783677</b>
W12F/40-600	38/597/1032	817	7321677836789	<b>783678</b>

718205



P151352

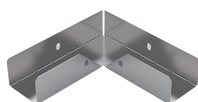

PTCSU-0067

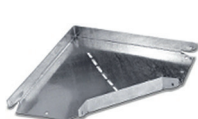

PTCSU-0024



784077

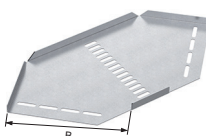

P151354



P129965



#### Junctions

Type	Dimensions A/B/C mm	Weight kg/100 pcs	EAN code	Ref. No.
<b>X-junction W13F</b>				
X-junction to be used for 90° horizontal junction of cable trays W3/40. Push-in assembly. Material: Sheet steel, hot-dip galvanized.				
W13/40-50 (flat)	-/248/248	26.5	3606480995033	<b>CSU795389</b>
W13F/40-50	38/47/148	21	7321677836802	<b>783680</b>
W13F/40-70	38/67/217	34	7321677836819	<b>783681</b>
W13F/40-100	38/97/313	59	7321677836826	<b>783682</b>
W13F/40-150	38/147/434	117	7321677836833	<b>783683</b>
W13F/40-200	38/197/555	194	7321677836840	<b>783684</b>
W13F/40-300	38/297/662	370	7321677836857	<b>783685</b>
W13F/40-400	38/397/762	510	7321677836864	<b>783686</b>
W13F/40-500	38/497/932	766	7321677836871	<b>783687</b>
W13F/40-600	38/597/1032	966	7321677836888	<b>783688</b>

#### Vertical risers

<b>Vertical riser W11</b>				
Vertical riser to be used as internal or external riser for cable trays W3/40. The riser is delivered flat and can be bent to the desired angle up to 90°. Push-in assembly. Material: Sheet steel, hot-dip galvanized.				
W11/40-50	-/48/150	8	7321677341016	<b>734101</b>
W11/40-70	-/68/150	10	7321677341023	<b>734102</b>
W11/40-100	-/98/150	12	7321677341030	<b>734103</b>
W11/40-150	-/148/150	17	7321677341047	<b>734104</b>
W11/40-200	-/198/200	28	7321677341054	<b>734105</b>
W11/40-300	-/298/200	39	7321677341061	<b>734106</b>
W11/40-400	-/398/200	50	7321677341078	<b>734107</b>
W11/40-500	-/498/200	61	7321677341085	<b>734108</b>
W11/40-600	-/598/200	73	7321677341092	<b>734109</b>
<b>Vertical riser W11F</b>				
W11F40-50	-/48/300	26	7321677839087	<b>783908</b>
W11F40-70	-/68/300	31	7321677839094	<b>783909</b>
W11F40-100	-/98/300	40	7321677839100	<b>783910</b>
W11F40-150	-/148/300	51	7321677839117	<b>783911</b>
W11F40-200	-/198/300	66	7321677839124	<b>783912</b>
W11F40-300	-/298/300	109	7321677839131	<b>783913</b>
W11F40-400	-/398/300	140	7321677839148	<b>783914</b>
W11F40-500	-/498/300	164	7321677839155	<b>783915</b>
W11F40-600	-/598/300	195	7321677839162	<b>783916</b>
<b>Vertical riser W4</b>				
Vertical riser suitable for installation tray W4. To be used as internal or external riser. The riser is delivered flat and can be bent to the desired angle up to 90°. Material: Sheet steel, hot-dip galvanized.				
W4-50	16/52/250	15	7321677840977	<b>784097</b>
W4-75	16/77/250	19	7321677840984	<b>784098</b>
W4-100	16/102/250	24	7321677840991	<b>784099</b>
W4-150	16/152/250	33	7321677841004	<b>784100</b>
W4-200	16/202/250	42	7321677841011	<b>784101</b>
W4-250	16/252/250	58	7321677841028	<b>784102</b>
W4-300	16/302/250	68	7321677841035	<b>784103</b>
W4-400	16/402/250	77	7321677841042	<b>784104</b>

### Reducers

Type	Dimensions A/B/C mm	Weight kg/100 pcs	EAN code	Ref. No.
<b>Reducer W28/40</b>				
Reducer for cable tray W3, system height 40. To be used together with side joint W49 in side transitions. In centered transitions only two reducers W28 are necessary. Material: Sheet steel, hot-dip galvanized.				
W28/40-50	37.5/50/200	15	7321677935871	<b>793587</b>
W28/40-100	37.5/100/200	17	7321677935888	<b>793588</b>
W28/40-150	37.5/150/200	20	7321677935895	<b>793589</b>
W28/40-200	37.5/200/200	23	7321677935901	<b>793590</b>
W28/40-250	37.5/250/200	26	7321677935918	<b>793591</b>
W28/40-300	37.5/300/200	29	7321677935925	<b>793592</b>
W28/40-350	37.5/350/200	32	7321677935932	<b>793593</b>
W28/40-400	37.5/400/200	36	7321677935949	<b>793594</b>
W28/40-450	37.5/450/200	39	7321677935956	<b>793595</b>
W28/40-500	37.5/500/200	41	7321677935963	<b>793596</b>

### End covers

Type	Dimensions A/B/C mm	Weight kg/100 pcs	EAN code	Ref. No.
<b>End cover W45</b>				
End cover to be mounted at the ends of cable trays W3/40 and of lighting trunking W70. Provided with oval holes 6x55 mm on the sides. Push-in assembly. Material: Sheet steel, hot-dip galvanized.				
W45/40-70	38/100/68	8	7321677830305	<b>783030</b>
W45/40-100	38/100/98	9	7321677830312	<b>783031</b>
W45/40-150	38/100/148	10	7321677830329	<b>783032</b>
W45/40-200	38/100/198	12	7321677830336	<b>783033</b>
W45/40-300	38/100/298	15	7321677830343	<b>783034</b>
W45/40-400	38/100/398	18	7321677830350	<b>783035</b>
W45/40-500	38/100/498	21	7321677830367	<b>783036</b>
W45/40-600	38/100/598	24	7321677830374	<b>783037</b>

### Box plates

Type	Dimensions A/B/C mm	Weight kg/100 pcs	EAN code	Ref. No.
<b>Junction box plate W24</b>				
Junction box plate, with perforated hole pattern. To be used for the installation of junction boxes, light fittings, etc., in cable trays W3/40 and in lighting trunking W70. Material: Sheet steel, hot-dip galvanized.				
W24/40	161/43/200	27	7321677346172	<b>734617</b>

### Screws, bolts and nuts

Type	Dimensions A/B/C mm	Weight kg/100 pcs	EAN code	Ref. No.
<b>Screw set 22S</b>				
Screw set to be used for installation of Ceiling bracket 5 on Pendant/fixing rails 24/34 and 24/48, Angle bracket 5L against the back of Pendant/fixing rails, Pendant/fixing rails back to back. Set including screw MVBFB 8x16 and nut M6MF8. Material: Steel, hot-dip galvanized.				
22S	-	1.9	7321677136940	<b>713694</b>

Type	Dimensions A/B/C mm	Weight kg/100 pcs	EAN code	Ref. No.
<b>Screw set W34</b>				
Screw set to be used for mounting of Cable tray W3 onto Cantilever arm 50 and Angle bracket W8 onto Pendant rail W32, Junction box plate W24 onto W3 Cable tray or Lighting trunking W70, as well as for assembly of Angle bracket W8 (light fitting bracket) and for joining of W4 Installation trays. Set including screw MSCS 6x12 and nut M6MF6. Material: Steel, Dacromet.				
W34	10/10/16	0.8	7321677346462	<b>734646</b>

Type	Dimensions A/B/C mm	Weight kg/100 pcs	EAN code	Ref. No.
<b>Screw set W38P C4</b>				
Screw set including screw and nut, to be used for the mounting of joints, bends, junctions. Material: Steel. Corrosion class: C4.				
W38P	-	0.4	7321677351770	<b>735177</b>

Type	Dimensions A/B/C mm	Weight kg/100 pcs	EAN code	Ref. No.
<b>T-bolt 26U</b>				
T-bolt to be used for mounting with all vertical pieces (except Vertical piece 2) and with Pendant/fixing rail 24/48. Material: Steel, hot-dip galvanized.				
26U M8x30	50/44/18	6.8	3606489579777	<b>CSU795595</b>
26U M10x30	50/44/18	6.8	3606489579715	<b>CSU795589</b>
26U M10x40	60/44/18	8.2	3606489579722	<b>CSU795590</b>
26U M10x50	70/44/18	9.5	3606489579739	<b>CSU795591</b>



#### Screws, bolts and nuts

Type	Dimensions A/B/C mm	Weight kg/100 pcs	EAN code	Ref. No.
<b>Spring nut M8</b>				
Spring nut to be used for fastening of accessories (control panels, etc.) on Pendant/fixing rail 24/48. Material: Steel, hot-dip galvanized.				
M8	–	2.7	7321677164073	<b>716407</b>
<b>Locking plug W41</b>				
Locking plug to be used for quick locking of joints, bends and branches in cable trays and lighting trunking. Material: PP+GF10.				
W41	Ø14/10.5	0.1	7321677186457	<b>718645</b>

#### Threaded rods

<b>Threaded rod W76</b>				
Threaded rod for M8 ceiling mounting of cable support. For fixing, use Flange Nut M8 and for extension, Distance nut M8. Material: Steel, hot-dip galvanized.				
W76/M8	8/8/1000	32	3606480483783	<b>CSU794697</b>
	8/8/2000	64	3606480483776	<b>CSU734698</b>
<b>Flange nut</b>				
Flange Nut M8 to be mounted on Threaded rod W76. Intended for ceiling mounting of cable support. Material: Steel, hot-dip galvanized.				
Flange nut M8	17/17/8	1	3606480483806	<b>CSU794715</b>
<b>Distance nut</b>				
Distance nut M8 to be used as an extension and a coupler of Threaded rod W76. Intended for ceiling mounting of cable support. Material: Steel, hot-dip galvanized.				
Distance nut M8	15/15/30	4	3606480483790	<b>CSU794699</b>
<b>Nut M8, M10</b>				
Nut to be used for the mounting of Threaded rod W76 M8 and M10 respectively. Material: Steel, hot-dip galvanized.				
Nut M8	–	0.54	7321677250851	<b>725085</b>
Nut M10	–	1.1	7321677239382	<b>723938</b>
<b>Mounting set W78</b>				
Mounting set including washer Ø50 and nut M10, to be used for mounting of threaded rod W76 in plate material or light concrete ceilings. Material: Steel, hot-dip galvanized.				
W78	Ø50/M10	5.5	7321677170692	<b>717069</b>

#### Brackets

<b>Support bracket W1940</b>				
Support bracket to be used for invisible installation of cable trays W3/40. Material: Sheet steel, hot-dip galvanized.				
W1940-100	36/65/90	11	7321677344529	<b>734452</b>
W1940-200	36/65/190	22	7321677344536	<b>734453</b>
W1940-300	36/65/289	50	7321677344543	<b>734454</b>
W1940-400	36/65/389	68	7321677344550	<b>734455</b>
W1940-500	36/65/489	91	7321677344567	<b>734456</b>
W1940-600	36/65/589	110	7321677344574	<b>734457</b>

### Cantilever arms

Type	Dimensions A/B/C mm		Weight kg/100 pcs	EAN code	Ref. No.
------	------------------------	---	----------------------	----------	----------

#### Cantilever arm 50i

Cantilever arm to be used for lighter mountings on walls, vertical pieces or pendant/fixing rails. Dimensions 500 and 600 marked with \* will be available in middle of July 2016.  
Material: Steel, hot dip galvanized..

50i/100	120/180/40		42	3606480911293	<b>CSU795316</b>
50i/200	120/280/40		55	3606480911309	<b>CSU795317</b>
50i/300	120/380/40		68	3606480911316	<b>CSU795318</b>
50i/400	142/480/40		86	3606480911323	<b>CSU795319</b>
50i/500 *	130/580/50		160	3606480911330	<b>CSU795320</b>
50i/600 *	130/680/50		186	3606480911347	<b>CSU795321</b>



#### Cantilever arm 50

Cantilever arm for mounting on walls, pendant/fixing rails or vertical pieces.  
Material: Steel, hot-dip galvanized.

50-100	85/40/150		24	7321677234325	<b>723432</b>
50-150	85/40/200		28	7321677234332	<b>723433</b>
50-200	85/40/250		34	7321677234349	<b>723434</b>
50-300	105/40/350		60	7321677234363	<b>723436</b>
50-400	120/50/450		118	7321677234370	<b>723437</b>
50-500	140/50/550		172	7321677234387	<b>723438</b>
50-600	150/50/650		215	7321677234394	<b>723439</b>



#### Internal cantilever arm W17

Internal cantilever arm to be used for invisible mounting inside cable tray W3/40.  
Material: Sheet steel, hot-dip galvanized.

W17/40-100	140/55/119		16	7321677345724	<b>734572</b>
W17/40-200	140/55/219		35	7321677345731	<b>734573</b>
W17/40-300	165/75/319		80	7321677345748	<b>734574</b>
W17/40-400	165/75/419		100	7321677345755	<b>734575</b>



#### Adjustable internal cantilever arm W1840

Adjustable internal cantilever arm to be used for invisible mounting inside cable trays W3/40. Adjustability 0-25 mm (W1840-100) and 0-50 mm (W1840-200-600).

Material: Sheet steel, hot-dip galvanized.

W1840-100	160/60/88		36	7321677345786	<b>734578</b>
W1840-200	160/60/188		47	7321677345793	<b>734579</b>
W1840-300	185/60/289		120	7321677345809	<b>734580</b>
W1840-400	185/60/389		139	7321677345816	<b>734581</b>
W1840-500	185/60/489		156	7321677345823	<b>734582</b>
W1840-600	185/60/589		175	7321677345830	<b>734583</b>



#### Pendant bracket W81

Pendant bracket W81 is mounted under lighting trunking W70-50 and is attached with screw set W37. Pendant rail W32 is mounted mounted using screw set W37. Adjustable to ±18 mm.

Material: Sheet steel, hot-dip galvanized.

W81 M6	140/2/76		4.1	7321677687381	<b>CSU795377</b>
--------	----------	--	-----	---------------	------------------

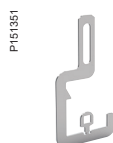

#### Wire Bracket W70-50

Wire bracket for screwless fixation, central suspension of lighting trunking W70-50.

Material: Steel, hot-dip galvanized.

Wire bracket	70/52/58		2.2	3606480994883	<b>CSU795370</b>
--------------	----------	--	-----	---------------	------------------



#### Back plate 40

Back plate to be used for installation behind Cantilever arm 50 and 50L to reduce the surface pressure on porous walls.

Material: Steel, hot-dip galvanized.

40	150/-/60		55	7321677687381	<b>768738</b>
----	----------	--	----	---------------	---------------



#### Mounting rail 40

Mounting rail to be used for wall installation of cantilever arms on porous walls to reduce the surface pressure or to enable height adjustment of cantilever arms.

Material: Steel, hot-dip galvanized.

40	48/26/270		56	7321677170012	<b>717001</b>
----	-----------	--	----	---------------	---------------



### Vertical pieces

Type	Dimensions A/B/C mm		Weight kg/100 pcs	EAN code	Ref. No.
<b>Vertical piece 2</b>					
Vertical piece to be used for installation of Support bracket W1940, symmetrical loading. Can be joined to Pendant/fixing rail 24/34 with Pendant joint 2J. Material: Steel, hot-dip galvanized.					
2-300	279/80/135		52	7321677171910	<b>717191</b>
2-400	392/80/135		62	7321677171927	<b>717192</b>
2-500	504/80/135		72	7321677171934	<b>717193</b>
2-700	729/80/135		93	7321677171941	<b>717194</b>
2-1000	1022/80/135		120	7321677171958	<b>717195</b>
<b>Vertical piece 2F</b>					
Vertical piece to be used for installation of Internal cantilever arm W17/40, Adjustable cantilever arm W18/40 or Cantilever arm 50/50L. Can be joined to Pendant/fixing rail 24/48 with Pendant joint 2FJ. Material: Steel, hot-dip galvanized.					
2F-280	280/80/135		80	7321677171965	<b>717196</b>
2F-370	370/80/135		100	7321677171972	<b>717197</b>
2F-505	505/80/135		130	7321677171989	<b>717198</b>
2F-730	730/80/135		170	7321677171996	<b>717199</b>
2F-1000	1000/80/135		220	7321677172009	<b>717200</b>
2F-1500	1495/80/135		290	7321677872763	<b>787276</b>

### Ceiling brackets

<b>Ceiling attachment W31</b>					
Ceiling attachment to be used for installations with Pendant rail W32. Material: Sheet steel, hot-dip galvanized.					
W31	70/64/25		6.5	7321677346196	<b>734619</b>
<b>Ceiling bracket 5</b>					
Ceiling bracket to be used for installations with Pendant/Fixing rails 24/34 and 24/48. Screw not included. Material: Steel, hot-dip galvanized.					
5	100/135/40		35	7321677186402	<b>718640</b>
<b>Ceiling bracket 5TPA</b>					
Ceiling bracket with telescopic function, to be used for mounting of various sizes of trapezoid plates. Including screw MVBF 8x16 and nut M6MF8. Breaking load: 150 kg without deformation. Material: Steel, hot-dip galvanized.					
5TPA	50/76/79-118		14	7321677334872	<b>733487</b>
<b>Ceiling bracket 5TP</b>					
Ceiling bracket to be used for installations of Vertical pieces 2, 2F and 20 in ceilings with a trapezoidal sheet profile. Material: Steel, hot-dip galvanized.					
5TP	75/35/50		12	7321677131532	<b>713153</b>

### Pendant/Fixing rails

<b>Pendant rail W32</b>					
Pendant rail to be installed in ceilings in combination with ceiling attachment W31. Material: Sheet steel, hot-dip galvanized.					
W32	3000/20/20		180	7321677346202	<b>734620</b>
<b>Pendant/Fixing rail 24/34</b>					
Pendant/Fixing rail for mounting of support brackets, cantilever arms, etc. Material: Steel, hot-dip galvanized.					
24/34	2970/16/42		240	7321677158799	<b>715879</b>

### Pendant/Fixing rails

Type	Dimensions A/B/C mm		Weight kg/100 pcs	EAN code	Ref. No.
------	------------------------	---	----------------------	----------	----------

#### Pendant/Fixing rail 24/48

Pendant/Fixing rail for mounting of support brackets, cantilever arms, etc.

Material: Steel, hot-dip galvanized.

24/48	1000/26/48		175	3606481317865	<b>CSU795565</b>
24/48	2970/26/48		520	7321677050932	<b>705093</b>
24/48	5940/26/48		1120	7321677317196	<b>731719</b>



P140345

#### Fixing rail 24/26x53 for casting-in

Fixing rail for casting-in in wall and ceilings.

Material: Steel, hot-dip galvanized.

24/26x53	4000/26/53		970	7321677680634	<b>768063</b>
----------	------------	--	-----	---------------	---------------



P139950

#### Pendant attachment W21

Pendant attachment to be used in combination with pendant rail W32, to construct a ceiling suspension.

Material: Sheet steel, hot-dip galvanized.

W21	97/50/21		12	7321677346189	<b>734618</b>
-----	----------	--	----	---------------	---------------



PTCSU-0010

### Pendant bars

#### Pendant bar 1

Pendant bar to be installed in order to reduce the deflection of heavily loaded vertical pieces. Installed with T-bolt and Expansion bolt.

Material: Steel, hot-dip galvanized.

1-300	315/161/40		35	7321677176403	<b>717640</b>
1-500	515/166/40		53	7321677176410	<b>717641</b>
1-800	815/246/40		82	7321677176427	<b>717642</b>



P140346

1-1500	1296/35/50		560	7321677189038	<b>718903</b>
--------	------------	--	-----	---------------	---------------



P140024

#### Bracket 60/40

Bracket to be used together with Pendant/fixing rail 24/34 to reduce the deflection of long vertical pieces.

Material: Steel, hot-dip galvanized.

60/40	95/23/40		10	7321677189045	<b>718904</b>
-------	----------	--	----	---------------	---------------



P139956

### Pendant joints

#### Pendant joint 2J and 2FJ

Pendant joint to be used for joining pendant/fixing rails and vertical pieces. Screws M8x16 and nuts included.

Material: Steel, hot-dip galvanized.

2J	200/48/18		43	7321677131778	<b>713177</b>
----	-----------	--	----	---------------	---------------





P140347

2FJ	200/55/18		46	7321677131785	<b>713178</b>
-----	-----------	--	----	---------------	---------------







P139960



### Angle brackets

Type	Dimensions A/B/C mm	Weight kg/100 pcs	EAN code	Ref. No.
 PTCSU-0011	<b>Angle bracket W8</b>			
	Angle bracket to be mounted inside a cable tray W3 for horizontal installation to the wall or vertical installation to the floor. Can also be mounted as a pendant bracket in the lighting trunking W70. Material: Sheet steel, hot-dip galvanized.			
W8	80/38/45	6	7321677288830	<b>728883</b>
 PTCSU-0012	<b>Angle bracket W8S</b>			
	Universal angle bracket to be used for various installations of pendant/fixing rail 24/34, support bracket, etc. Material: Sheet steel, hot-dip galvanized.			
W8S	120/30/30	8	7321677268733	<b>726873</b>



### Mounting rails/lashing wire

 P138271	<b>Mounting rail WMS25L</b>			
	Mounting rail to be used for installation directly on wall for lashing of cables. Material: Steel, hot-dip galvanized.			
WMS25L	3/25/2500	141	3606489584955	<b>CSU795597</b>
 P140226	<b>Lashing wire</b>			
	Lashing wire to be used for lashing of wires on cable ladders. Material: Stainless steel, PVC.			
HTR-2303, white PVC	Ø1.25	1.3/100 m	7321677136865	<b>713686</b>
 P140225	HTR-2313, black PVC			
	Ø1.25	1.3/100 m	7321677136872	<b>713687</b>
 P140228	Lashing wire to be used for lashing of wires on cable ladders. Material: PVC.			
	HT-2304, white	Ø1.5	1.8/100 m	7321677136841
 P140225	HT-2314, black			
	Ø1.5	1.8/100 m	7321677136858	<b>713685</b>

### End plugs

 P140067	<b>End plug 28C and E</b>			
	End plug to be mounted on pendant ends to provide protection against personal injury and to make the ends of the profiles more conspicuous. Material: PP/TPE, orange.			
28C for Vertical piece 2 and Pendant/fixing rail 24/34	25/19/46	0.5	7321677898756	<b>789875</b>
 P140069	28E for Vertical piece 2F and Pendant/fixing rail 24/48			
	24/30/52	0.5	7321677090211	<b>709021</b>

### Accessories

 P148804	<b>Strip fixing W44</b>			
	Strip fixing to be used for easy fixation of cables in an unperforated cable tray W1/40 or W1/60. Material: PPE.			
W44	5.5/25/96	1	7321677184699	<b>718469</b>
 B224310	<b>Protection strip W48</b>			
	Protection strip to be used to protect cables from sharp edges when cutting the cable tray W1/W3 or lighting trunking W70. Material: Plastic.			
W48	10/6/720	6.1	7321677872114	<b>787211</b>
 P149450	<b>Repair paint</b>			
	Anti-corrosive repair paint Galvafröid in a 0.4 l tin for the repair of damages on pre-galvanized or hot-dip galvanized trays and accessories.			
Anti-corrosive repair paint	–	104	7321677176373	<b>717637</b>



#### Cable trays, perforated

Type	Dimensions A/B/C mm	Weight kg/100 m	EAN code	Ref. No.
------	------------------------	--------------------	----------	----------

#### Cable tray W3

Perforated cable tray for indoor or outdoor industrial applications. System height 40 mm. Provided with holes Ø 5.8 mm at the tray end to be used for fixation of joints. Oval holes along the lateral sides of the tray can be used for mounting of accessories.  
Material: Sheet steel, Zinkpox coated white.

W3/40-50	40/50/3000	110	7321677354122	<b>735412</b>
W3/40-70	40/70/3000	120	7321677354139	<b>735413</b>
W3/40-100	40/100/3000	156	7321677354146	<b>735414</b>
W3/40-150	40/150/3000	170	7321677354153	<b>735415</b>
W3/40-200	40/200/3000	220	7321677354160	<b>735416</b>
W3/40-300	40/300/3000	350	7321677354177	<b>735417</b>
W3/40-400	40/400/3000	453	7321677354184	<b>735418</b>
W3/40-500	40/500/3000	620	7321677354191	<b>735419</b>
W3/40-600	40/600/3000	723	7321677354207	<b>735420</b>

#### Installation tray W4

Perforated installation tray for indoor or outdoor industrial applications. To be used when leading cables down from a cable ladder to machine cabinets, etc. Provided with holes Ø 3.5 mm in the bottom segment of the tray for the clamping of cables with plate screws.

Material: Sheet steel, Zinkpox coated white.

W4-50	15/50/3000	57	7321677359998	<b>735999</b>
W4-75	15/75/3000	76	7321677360000	<b>736000</b>
W4-100	15/100/3000	93	7321677360017	<b>736001</b>
W4-150	15/150/3000	125	7321677360024	<b>736002</b>
W4-200	15/200/3000	195	7321677360031	<b>736003</b>
W4-250	15/250/3000	228	7321677360048	<b>736004</b>
W4-300	15/300/1960	238	7321677360055	<b>736005</b>
W4-400	15/400/1960	313	7321677360062	<b>736006</b>

#### Lighting trunking

#### Lighting trunking W70-50, -70, -100

Cable tray with bottom perforation for indoor applications in dry environments. System height 40 mm, length 3000 mm. Oval holes 9x5.8 mm on the lateral sides of the tray end can be used for fixation of joints. The oval hole pattern at the base of the tray can be used for mounting of lighting fixtures. On every 500 mm an oval hole is placed to easily guide fast connectors into the tray.

Material: Sheet steel, Zinkpox coated white.

W70-50	40/50/3000	285	3606480756122	<b>CSU795219</b>
W70-70	40/70/3000	293	3606480464843	<b>CSU794531</b>
W70-100	40/100/3000	346	3606480464850	<b>CSU794532</b>

PTCSU-0018



ODA735992-bis



PTCSU-0019



### Covers

Type	Dimensions A/B/C mm		Weight kg/100 pcs	EAN code	Ref. No.
<b>Cover W5</b>					
Cover to be used to protect the cables inside the cable tray against damages, dust, liquids, UV-influence, etc. Material: Sheet steel, Zinkpox coated white.					
W5-70	10/71/2000		160	7321677823635	<b>782363</b>
W5-100	10/101/2000		210	7321677823642	<b>782364</b>
W5-150	10/151/2000		290	7321677823659	<b>782365</b>
W5-200	10/201/2000		370	7321677823666	<b>782366</b>
W5-300	10/301/2000		540	7321677823673	<b>782367</b>
W5-400	10/401/2000		710	7321677823680	<b>782368</b>
W5-500	10/501/2000		880	7321677823697	<b>782369</b>
W5-600	10/601/2000		1050	7321677823703	<b>782370</b>
<b>Cover clamp W62</b>					
Cover clamp to be used for the fixing of covers on cable trays W3 as well as on lighting trunking W70. Material: Stainless steel 304.					
W62	-/15/10.5		0.8	7321677301867	<b>730186</b>

### Joints

<b>Joint W7/40</b>					
To be used as a joint for cable tray W3/40 and for lighting trunking W70. Material: Sheet steel, Zinkpox coated white.					
W7/40-50	38/46/200		18	7321677912827	<b>791282</b>
<b>40-50</b>					
W7/40-70	38/66/200		21	7321677912834	<b>791283</b>
W7/40-100	38/96/200		26	7321677912841	<b>791284</b>
<b>40-70, 100</b>					
W7/40-150	38/146/200		34	7321677912858	<b>791285</b>
<b>40-150</b>					
W7/40-200	38/196/200		42	7321677912865	<b>791286</b>
W7/40-300	38/296/300		107	7321677912872	<b>791287</b>
W7/40-400	38/396/300		137	7321677912889	<b>791288</b>
<b>40-200, 300, 400</b>					
W7/40-500	38/496/300		166	7321677912896	<b>791289</b>
W7/40-600	38/596/300		195	7321677912902	<b>791290</b>
<b>40-500, 600</b>					
<b>Side joint W49</b>					
Side joint to be used for straight joining of cable tray W3/40. Material: Sheet steel, Zinkpox coated white.					
W49/40	37.5/-/300		17	7321677902316	<b>790231</b>
<b>Joint W2</b>					
Side joint to be used for straight joining of installation tray W4. Material: Sheet steel, Zinkpox coated white.					
W2	15/25/200		8	7321677885756	<b>788575</b>
<b>T-joint W9</b>					
T-joint to be used to construct T-sections or X-sections. Also used for oblique branches. The ref. number includes two pieces of T-joints and Screw set W38P. Material: Sheet steel, Zinkpox coated white.					
W9/40	40/72.5/200		6	7321677831289	<b>783128</b>

### Bends

Type	Dimensions A/B/C mm	Weight kg/100 m	EAN code	Ref. No.
<b>90° bend W10F</b>				
Horizontal 90° bend to be used for cable trays W3/40. Push-in assembly. Material: Sheet steel, Zinkpox coated white.				
W10/40-50 (flat)	38/183/183	14.9	3606480994968	<b>CSU795382</b>
W10F/40-50	38/47/119	14	7321677836000	<b>783600</b>
W10F/40-70	38/67/153	23	7321677836017	<b>783601</b>
W10F/40-100	38/97/204	39	7321677836024	<b>783602</b>
W10F/40-150	38/147/290	74	7321677836031	<b>783603</b>
W10F/40-200	38/197/375	119	7321677836048	<b>783604</b>
W10F/40-300	38/297/480	242	7321677836055	<b>783605</b>
W10F/40-400	38/397/580	353	7321677836062	<b>783606</b>
W10F/40-500	38/497/714	528	7321677836079	<b>783607</b>
W10F/40-600	38/597/814	685	7321677836086	<b>783608</b>
<b>Adjustable bend W10S</b>				
Adjustable bend to be used for horizontal angling from 105° to 165° in steps of 7.5°. Push-in assembly. Material: Sheet steel, Zinkpox coated white.				
W10S/40-50	38/47/47	9	7321677828500	<b>782850</b>
W10S/40-70	38/67/67	10	7321677828517	<b>782851</b>
W10S/40-100	38/97/97	13	7321677828524	<b>782852</b>
W10S/40-150	38/147/147	24	7321677828531	<b>782853</b>
W10S/40-200	38/197/197	40	7321677828548	<b>782854</b>
W10S/40-300	38/297/297	94	7321677828555	<b>782855</b>
W10S/40-400	38/397/397	156	7321677828562	<b>782856</b>
W10S/40-500	38/497/497	270	7321677828579	<b>782857</b>
W10S/40-600	38/597/597	380	7321677828586	<b>782858</b>
<b>90° bend W4</b>				
Horizontal 90° bend to be used for cable tray W4. To be mounted on the outside of the tray and attached in the bottom segment with screw set W38P. Material: Sheet steel, Zinkpox coated white.				
W4-50	16/52/-	10	7321677936779	<b>793677</b>
W4-75	16/77/-	15	7321677936786	<b>793678</b>
W4-100	16/102/-	22	7321677936793	<b>793679</b>
W4-150	16/152/-	37	7321677936809	<b>793680</b>
W4-200	16/202/-	55	7321677936816	<b>793681</b>
W4-250	16/252/-	77	7321677936823	<b>793682</b>
W4-300	16/302/-	102	7321677936830	<b>793683</b>
W4-400	16/402/-	161	7321677936847	<b>793684</b>

### Junctions

Type	Dimensions A/B/C mm	Weight kg/100 m	EAN code	Ref. No.
<b>T-junction W12F</b>				
T-junction to be used for 90° horizontal junction of cable trays W3/40. Push-in assembly. Material: Sheet steel, Zinkpox coated white.				
W12/40-50 (flat)	-/185/248	23.2	3606480995002	<b>CSU795386</b>
W12F/40-50	38/47/171	26	7321677836208	<b>783620</b>
W12F/40-70	38/67/219	35	7321677836215	<b>783621</b>
W12F/40-100	38/97/312	60	7321677836222	<b>783622</b>
W12F/40-150	38/147/432	110	7321677836239	<b>783623</b>
W12F/40-200	38/197/553	192	7321677836246	<b>783624</b>
W12F/40-300	38/297/662	300	7321677836253	<b>783625</b>
W12F/40-400	38/397/762	428	7321677836260	<b>783626</b>
W12F/40-500	38/497/932	640	7321677836277	<b>783627</b>
W12F/40-600	38/597/1032	817	7321677836284	<b>783628</b>

#### Junctions

Type	Dimensions A/B/C mm	Weight kg/100 pcs	EAN code	Ref. No.
<b>X-junction W13F</b>				
X-junction to be used for 90° horizontal junction of cable trays W3/40. Push-in assembly. Material: Sheet steel, Zinkpox coated white.				
W13/40-50 (flat)	-/248/248	28.1	3606480995040	<b>CSU795390</b>
W13F/40-50	38/47/148	27	7321677836406	<b>783640</b>
W13F/40-70	38/67/217	43	7321677836413	<b>783641</b>
W13F/40-100	38/97/313	74	7321677836420	<b>783642</b>
W13F/40-150	38/147/434	147	7321677836437	<b>783643</b>
W13F/40-200	38/197/555	243	7321677836444	<b>783644</b>
W13F/40-300	38/297/662	370	7321677836451	<b>783645</b>
W13F/40-400	38/397/762	510	7321677836468	<b>783646</b>
W13F/40-500	38/497/932	766	7321677836475	<b>783647</b>
W13F/40-600	38/597/1032	966	7321677836482	<b>783648</b>

#### Vertical risers

<b>Vertical riser W11</b>				
Vertical riser to be used as internal or external riser for cable tray W3/40. The riser is delivered flat and can be bent to the desired angle up to 90°. Push-in assembly. Material: Sheet steel, Zinkpox coated white.				
W11/40-50	-/48/150	8	7321677830404	<b>783040</b>
W11/40-70	-/68/150	10	7321677830411	<b>783041</b>
W11/40-100	-/98/150	12	7321677830428	<b>783042</b>
W11/40-150	-/148/150	17	7321677830435	<b>783043</b>
W11/40-200	-/198/200	28	7321677830442	<b>783044</b>
W11/40-300	-/298/200	39	7321677830459	<b>783045</b>
W11/40-400	-/398/200	50	7321677830466	<b>783046</b>
W11/40-500	-/498/200	61	7321677830473	<b>783047</b>
W11/40-600	-/598/200	73	7321677830480	<b>783048</b>

<b>Vertical riser W4</b>				
Vertical riser suitable for installation tray W4. To be used as internal or external riser. The riser is delivered flat and can be bent to the desired angle up to 90°. Push-in assembly. Material: Sheet steel, Zinkpox coated white.				
W4-50	16/52/250	15	7321677936694	<b>793669</b>
W4-75	16/77/250	19	7321677936700	<b>793670</b>
W4-100	16/102/250	24	7321677936717	<b>793671</b>
W4-150	16/152/250	33	7321677936724	<b>793672</b>
W4-200	16/202/250	42	7321677936731	<b>793673</b>
W4-250	16/252/250	58	7321677936748	<b>793674</b>
W4-300	16/302/250	68	7321677936755	<b>793675</b>
W4-400	16/402/250	77	7321677936762	<b>793676</b>

#### Reducers

<b>Reducer W28/40</b>				
Reducer for cable tray W3, system height 40. To be used together with side joint W49 in side transitions. In centered transitions only two reducers W28 are necessary. Material: Sheet steel, Zinkpox coated white.				
W28/40-50	37.5/50/200	15	7321677935970	<b>793597</b>
W28/40-100	37.5/100/200	17	7321677935987	<b>793598</b>
W28/40-150	37.5/150/200	20	7321677935994	<b>793599</b>
W28/40-200	37.5/200/200	23	7321677936007	<b>793600</b>
W28/40-250	37.5/250/200	26	7321677936014	<b>793601</b>
W28/40-300	37.5/300/200	29	7321677936021	<b>793602</b>
W28/40-350	37.5/350/200	32	7321677936038	<b>793603</b>
W28/40-400	37.5/400/200	36	7321677936045	<b>793604</b>
W28/40-450	37.5/450/200	39	7321677936052	<b>793605</b>
W28/40-500	37.5/500/200	41	7321677936069	<b>793606</b>

#### End covers

Type	Dimensions A/B/C mm		Weight kg/100 pcs	EAN code	Ref. No.
<b>End cover W45</b>					
End cover to be mounted at the ends of cable trays W3/40 and of lighting trunking W70. Provided with oval holes 6x55 mm on the sides. Push-in assembly. Material: Sheet steel, Zinkpox coated white.					
W45/40-70	38/100/68		8	7321677830008	<b>783000</b>
W45/40-100	38/100/98		9	7321677830015	<b>783001</b>
W45/40-150	38/100/148		10	7321677830022	<b>783002</b>
W45/40-200	38/100/198		12	7321677830039	<b>783003</b>
W45/40-300	38/100/298		15	7321677830046	<b>783004</b>
W45/40-400	38/100/398		18	7321677830053	<b>783005</b>
W45/40-500	38/100/498		21	7321677830060	<b>783006</b>
W45/40-600	38/100/598		24	7321677830077	<b>783007</b>





#### Box plates

<b>Junction box plate W24</b>					
Junction box plate with perforated hole pattern. To be used for the installation of junction boxes, light fittings, etc., in cable trays W3/40 and in lighting trunking W70. Material: Sheet steel, Zinkpox coated white.					
W24/40	161/43/200		27	7321677831302	<b>783130</b>

#### Screws, bolts and nuts

<b>Screw set 22S</b>					
Screw set to be used for installation of Ceiling bracket 5 on Pendant/fixing rails 24/34 and 24/48, Angle bracket 5L against the back of Pendant/fixing rails, Pendant/fixing rails back to back. Set including screw MVBF 8x16 and nut M6MF8. Material: Steel, hot-dip galvanized.					
22S	–		1.9	7321677136940	<b>713694</b>
<b>Screw set W34</b>					
Screw set to be used for mounting of Cable tray W3 onto Cantilever arm 50 and Angle bracket W8 onto Pendant rail W32, Junction box plate W24 onto W3 Cable tray or Lighting trunking W70, as well as for assembly of Angle bracket W8 (light fitting bracket) and for joining of W4 Installation trays. Set including screw MSCS 6x12 and nut M6MF6. Material: Steel, Dacromet.					
W34	10/10/16		0.8	7321677346462	<b>734646</b>
<b>Screw set W38P C4</b>					
Screw set including screw and nut, to be used for the mounting of joints, bends, junctions. Material: Steel. Corrosion class: C4.					
W38P	–		0.4	7321677351770	<b>735177</b>
<b>T-bolt 26U</b>					
T-bolt to be used for mounting with all vertical pieces (except Vertical piece 2) and with Pendant/fixing rail 24/48. Material: Steel, hot-dip galvanized.					
26U M8x30	50/44/18		6.8	3606489579777	<b>CSU795595</b>
26U M10x30	50/44/18		6.8	3606489579715	<b>CSU795589</b>
26U M10x40	60/44/18		8.2	3606489579722	<b>CSU795590</b>
26U M10x50	70/44/18		9.5	3606489579739	<b>CSU795591</b>
<b>Spring nut M8</b>					
Spring nut to be used for fastening of accessories (control panels, etc.) on Pendant/fixing rail 24/48. Material: Steel, hot-dip galvanized.					
M8	–		2.7	7321677164073	<b>716407</b>
<b>Locking plug W41</b>					
Locking plug to be used for quick locking of joints, bends and branches in cable trays and lighting trunking. Material: PP+GF10.					
W41	Ø14/10.5		0.1	7321677186457	<b>718645</b>

#### Threaded rods

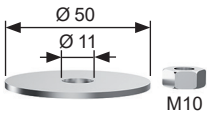
Type	Dimensions A/B/C mm	Weight kg/100 pcs	EAN code	Ref. No.	
<b>Threaded rod W76</b>					
Threaded rod for M8 ceiling mounting of cable support. For fixing, use Flange Nut M8 and for extension, Distance nut M8. Material: Steel, hot-dip galvanized.					
 <small>csu08050000</small>	W76/M8	8/8/1000	32	3606480483783	<b>CSU794697</b>
		8/8/2000	64	3606480483776	<b>CSU734698</b>
<b>Flange nut</b>					
Flange Nut M8 to be mounted on Threaded rod W76. Intended for ceiling mounting of cable support. Material: Steel, hot-dip galvanized.					
 <small>P140154</small>	Flange nut M8	17/17/8	1	3606480483806	<b>CSU794715</b>
<b>Distance nut</b>					
Distance nut M8 to be used as an extension and a coupler of Threaded rod W76. Intended for ceiling mounting of cable support. Material: Steel, hot-dip galvanized.					
 <small>PTCSU-0043</small>	Distance nut M8	15/15/30	4	3606480483790	<b>CSU794699</b>
<b>Nut M8, M10</b>					
Nut to be used for the mounting of Threaded rod W76 M8 and M10 respectively. Material: Steel, hot-dip galvanized.					
 <small>ODAN223896</small>	Nut M8	–	0.54	7321677250851	<b>725085</b>
	Nut M10	–	1.1	7321677239382	<b>723938</b>
<b>Mounting set W78</b>					
Mounting set including washer Ø50 and nut M10, to be used for mounting of threaded rod W76 in plate material or light concrete ceilings. Material: Steel, hot-dip galvanized.					
 <small>717069</small>	W78	Ø50/M10	5.5	7321677170692	<b>717069</b>

#### Brackets

<b>Support bracket W1940</b>					
Support bracket to be used for invisible installation of cable trays W3/40. Material: Sheet steel, Zinkpox coated white.					
 <small>PTCSU-0037</small>	W1940-100	36/65/90	11	7321677830602	<b>783060</b>
	W1940-200	36/65/190	22	7321677830619	<b>783061</b>
	W1940-300	36/65/289	50	7321677830626	<b>783062</b>
	W1940-400	36/65/389	68	7321677830633	<b>783063</b>
	W1940-500	36/65/489	91	7321677830640	<b>783064</b>
	W1940-600	36/65/589	110	7321677830657	<b>783065</b>

#### Cantilever arms

<b>Cantilever arm 50</b>					
Cantilever arm for mounting on walls, pendant/fixing rails or vertical pieces. Material: Sheet steel, Zinkpox coated white.					
 <small>P140016</small>	50-100	85/40/150	24	7321677234400	<b>723440</b>
	50-150	85/40/200	28	7321677234417	<b>723441</b>
	50-200	85/40/250	34	7321677234424	<b>723442</b>
	50-300	105/40/350	60	7321677234448	<b>723444</b>
	50-400	120/50/450	228	7321677234455	<b>723445</b>
	50-500	140/50/550	172	7321677234462	<b>723446</b>
	50-600	150/50/650	215	7321677234479	<b>723447</b>



#### Cantilever arms

PTCSL-0005



Type	Dimensions A/B/C mm	Weight kg/100 pcs	EAN code	Ref. No.
<b>Internal cantilever arm W17/40</b>				
Internal cantilever arm to be used for invisible mounting inside cable tray W3/40. Material: Sheet steel, Zinkpox coated white.				
W17/40-100	140/55/119	16	7321677830664	<b>783066</b>
W17/40-200	140/55/219	35	7321677830671	<b>783067</b>
W17/40-300	165/75/319	80	7321677830688	<b>783068</b>
W17/40-400	165/75/419	100	7321677830695	<b>783069</b>

782933



<b>Adjustable internal cantilever arm W1840</b>				
Adjustable internal cantilever arm to be used for invisible mounting inside cable trays W3/40. Adjustability 0-25 mm (W1840-100) and 0-50 mm (W1840-200 to 600). Material: Sheet steel, Zinkpox coated white.				
W1840-100	160/60/88	36	7321677830183	<b>783018</b>
W1840-200	160/60/188	47	7321677830190	<b>783019</b>
W1840-300	185/60/289	120	7321677830206	<b>783020</b>
W1840-400	185/60/389	139	7321677830213	<b>783021</b>
W1840-500	185/60/489	156	7321677830220	<b>783022</b>
W1840-600	185/60/589	175	7321677830237	<b>783023</b>

P151351



<b>Pendant bracket W81</b>				
Pendant bracket W81 is mounted under lighting trunking W70-50 and is attached with screw set W37. Pendant rail W32 is mounted mounted using screw set W37. Adjustable to ± 18 mm. Material: Sheet steel, Zinkpox coated white.				
W81 M6	140/2/76	4.1	3606480994920	<b>CSU795378</b>

P151349



<b>Wire bracket W70-50</b>				
Wire bracket for screwless fixation, central suspension of lighting trunking W70-50. Material: Steel, hot-dip galvanized.				
Wire bracket	70/52/58	2.2	3606480994883	<b>CSU795370</b>

P140029



<b>Back plate 40</b>				
Back plate to be used for installation behind Cantilever arm 50 and 50L to reduce the surface pressure on porous walls. Material: Sheet steel, Zinkpox coated white.				
40	150/-/60	55	7321677140299	<b>714029</b>

P140061



<b>Mounting rail 40</b>				
Mounting rail to be used for wall installation of cantilever arms on porous walls to reduce the surface pressure or to enable height adjustment of cantilever arms. Material: Sheet steel, Zinkpox coated white.				
40	48/26/270	56	7321677290451	<b>729045</b>

#### Vertical pieces

P139937



<b>Vertical piece 2</b>				
Vertical piece to be used for installation of Support bracket W1940, symmetrical loading. Can be joined to Pendant/fixing rail 24/34 with Pendant joint 2J. Material: Sheet steel, Zinkpox coated white.				
2-300	279/80/135	52	7321677162833	<b>716283</b>
2-400	392/80/135	62	7321677162840	<b>716284</b>
2-500	504/80/135	72	7321677162857	<b>716285</b>
2-700	729/80/135	93	7321677162864	<b>716286</b>
2-1000	1022/80/135	120	7321677162871	<b>716287</b>

P139938



<b>Vertical piece 2F</b>				
Vertical piece to be used for installation of Internal cantilever arm W17/40, Adjustable cantilever arm W18/40 or Cantilever arm 50/50L. Can be joined to Pendant/fixing rail 24/48 with Pendant joint 2FJ. Material: Sheet steel, Zinkpox coated white.				
2F-280	280/80/135	80	7321677172016	<b>717201</b>
2F-370	370/80/135	100	7321677172023	<b>717202</b>
2F-505	505/80/135	130	7321677172030	<b>717203</b>
2F-730	730/80/135	170	7321677172047	<b>717204</b>
2F-1000	1000/80/135	220	7321677172054	<b>717205</b>
2F-1500	1495/80/135	290	7321677872770	<b>787277</b>

#### Ceiling brackets

Type	Dimensions A/B/C mm		Weight kg/100 pcs	EAN code	Ref. No.
<b>Ceiling attachment W31</b>					
Ceiling attachment to be used for installations with Pendant rail W32. Material: Sheet steel, Zinkpox coated white.					
W31	70/64/25		6.5	7321677831203	<b>783120</b>
<b>Ceiling bracket 5</b>					
Ceiling bracket to be used for installations with Pendant/Fixing rails 24/34 and 24/48. Screw not included. Material: Sheet steel, Zinkpox coated white.					
5	100/135/40		35	7321677162932	<b>716293</b>
<b>Ceiling bracket 5TP</b>					
Ceiling bracket to be used for installations of Vertical pieces 2, 2F and 20 in ceilings with a trapezoidal sheet profile. Material: Steel, Zinkpox coated white.					
5TP	75/35/50		12	7321677162956	<b>716295</b>

#### Pendant/Fixing rails

<b>Pendant rail W32</b>					
Pendant rail to be installed in ceilings in combination with ceiling attachment W31. Material: Sheet steel, Zinkpox coated white.					
W32	3000/20/20		180	7321677831227	<b>783122</b>
<b>Pendant/Fixing rail 24/34</b>					
Pendant/Fixing rail for mounting of support brackets, cantilever arms, etc. Material: Sheet steel, Zinkpox coated white.					
24/34	2970/16/42		240	7321677163090	<b>716309</b>
<b>Pendant/Fixing rail 24/48</b>					
Pendant/Fixing rail for mounting of support brackets, cantilever arms, etc. Material: Steel, Zinkpox coated white.					
24/48	1000/26/48		175	3606481317865	<b>CSU795565</b>
24/48	2970/26/48		520	7321677163069	<b>716306</b>
24/48	5940/26/48		1120	7321677317240	<b>731724</b>
<b>Pendant attachment W21</b>					
Pendant attachment to be used in combination with pendant rail W32, to construct a ceiling suspension. Material: Sheet steel, Zinkpox coated white.					
W21	97/50/21		12	7321677831074	<b>783107</b>

#### Pendant bars

Type	Dimensions A/B/C mm		Weight kg/100 pcs	EAN code	Ref. No.
<b>Pendant bar 1</b>					
Pendant bar to be installed in order to reduce the deflection of heavily loaded vertical pieces. Installed with T-bolt and Expansion bolt. Material: Sheet steel, Zinkpox coated white.					
1-300	315/161/40		35	7321677176434	<b>717643</b>
1-500	515/166/40		53	7321677176441	<b>717644</b>
1-800	815/246/40		82	7321677176458	<b>717645</b>
1-1500	1296/35/50		560	7321677205301	<b>720530</b>
<b>Bracket 60/40</b>					
Bracket to be used together with Pendant/fixing rail 24/34 to reduce the deflection of long vertical pieces. Material: Sheet steel, Zinkpox coated white.					
60/40	95/23/40		10	7321677205318	<b>720531</b>

#### Pendant joints

<b>Pendant joint 2J and 2FJ</b>					
Pendant joint to be used for joining pendant/fixing rails and vertical pieces. Screws M8x16 and nuts included. Material: Steel, Zinkpox coated white.					
2J	200/48/18		43	7321677163038	<b>716303</b>
2FJ	200/55/18		46	7321677163045	<b>716304</b>

#### Angle brackets

<b>Angle bracket W8</b>					
Angle bracket to be mounted inside a cable trays W3 for horizontal installation to the wall or vertical installation to the floor. Can also be mounted as a pendant bracket in the lighting trunking W70. Material: Sheet steel, Zinkpox coated white.					
W8	80/38/45		6	7321677831241	<b>783124</b>
<b>Angle bracket W8S</b>					
Universal angle bracket to be used for various installations of pendant/fixing rail 24/34, support bracket, etc. Material: Sheet steel, Zinkpox coated white.					
W8S	120/30/30		8	7321677831265	<b>783126</b>

#### End plugs

<b>End plug 28C and E</b>					
End plug to be mounted on pendant ends to provide protection against personal injury and to make the ends of the profiles more conspicuous. Material: PP/TPE, orange.					
28C for Vertical piece 2 and Pendant/fixing rail 24/34	25/19/46		0.5	7321677898756	<b>789875</b>
28E for Vertical piece 2F and Pendant/fixing rail 24/48	24/30/52		0.5	7321677090211	<b>709021</b>

#### Accessories

	Type	Dimensions A/B/C mm		Weight kg/100 pcs	EAN code	Ref. No.
<b>Lashing wire</b>						
Lashing wire to be used for lashing of wires on cable ladders. Material: Stainless steel, PVC.						
P140226	HTR-2303, white PVC	Ø1.25		1.3/100 m	7321677136865	<b>713686</b>
P140225	HTR-2313, black PVC	Ø1.25		1.3/100 m	7321677136872	<b>713687</b>
Lashing wire to be used for lashing of wires on cable ladders. Material: PVC.						
P140226	HT-2304, white	Ø1.5		1.8/100 m	7321677136841	<b>713684</b>
P140225	HT-2314, black	Ø1.5		1.8/100 m	7321677136858	<b>713685</b>
<b>Strip fixing W44</b>						
Strip fixing to be used for easy fixation of cables in an unperforated cable tray W1/40 or W1/60. Material: PPE.						
P146804	W44	5.5/25/96		1	7321677184699	<b>718469</b>
<b>Protection strip W48</b>						
Protection strip to be used to protect cables from sharp edges when cutting the cable tray W1/W3 or lighting trunking W70. Material: Plastic.						
PTCSU-0013	W48	10/6/720		6.1	7321677872114	<b>787211</b>
<b>Repair paint</b>						
Repair paint for the repair of minor damages of powder-coated products. Colour white RAL 9003, gloss 30.						
P1489450	Spray bottle, 0.4 litres	—		60	7321677397136	<b>739713</b>

#### Cable trays, perforated

ODA735992-016



Type	Dimensions A/B/C mm	Weight kg/100 m	EAN code	Ref. No.
<b>Installation tray W4</b>				
Perforated installation tray for both indoor and outdoor applications having high demands on corrosion resistance. To be used when leading cables down from a cable ladder to machine cabinets, etc. Provided with holes Ø 3.5 mm in the bottom segment of the tray for the clamping of cables with plate screws. Material: Stainless steel AISI316L.				
W4-50	15/50/3000	56	7321677834709	<b>783470</b>
W4-75	15/75/3000	73	7321677834716	<b>783471</b>
W4-100	15/100/3000	90	7321677834723	<b>783472</b>
W4-150	15/150/3000	119	7321677834730	<b>783473</b>
W4-200	15/200/3000	149	7321677834747	<b>783474</b>
W4-250	15/250/3000	181	7321677834754	<b>783475</b>
W4-300	15/300/3000	214	7321677834761	<b>783476</b>
W4-400	15/400/3000	279	7321677834778	<b>783477</b>

#### Joints

PTCSU-0023



<b>Joint W2</b>				
Side joint to be used for straight joining of installation tray W4. Material: Stainless steel AISI316L.				
W2	15/25/200	8	7321677834877	<b>783487</b>

#### Bends

784077

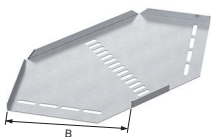

<b>90° bend W4</b>				
Horizontal 90° bend to be used for cable tray W4. To be mounted on the outside of the tray and attached in the bottom segment with screw set W34. Material: Stainless steel AISI316L.				
W4-50	16/52/-	10	7321677838844	<b>783884</b>
W4-75	16/77/-	15	7321677838851	<b>783885</b>
W4-100	16/102/-	22	7321677838868	<b>783886</b>
W4-150	16/152/-	37	7321677838875	<b>783887</b>
W4-200	16/202/-	55	7321677838882	<b>783888</b>
W4-250	16/252/-	77	7321677838899	<b>783889</b>
W4-300	16/302/-	102	7321677838905	<b>783890</b>
W4-400	16/402/-	161	7321677838912	<b>783891</b>





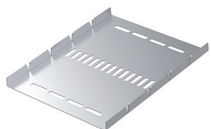

#### Vertical risers

784093



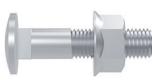

<b>Vertical riser W4</b>				
Vertical riser suitable for installation tray W4. To be used as internal or external riser. The riser is delivered flat and can be bent to the desired angle up to 90°. Material: Stainless steel AISI316L.				
W4-50	16/52/250	15	7321677839001	<b>783900</b>
W4-75	16/77/250	19	7321677839018	<b>783901</b>
W4-100	16/102/250	24	7321677839025	<b>783902</b>
W4-150	16/152/250	33	7321677839032	<b>783903</b>
W4-200	16/202/250	42	7321677839049	<b>783904</b>
W4-250	16/252/250	58	7321677839056	<b>783905</b>
W4-300	16/302/250	68	7321677839063	<b>783906</b>
W4-400	16/402/250	77	7321677839070	<b>783907</b>

#### Screws, bolts and nuts

Type	Dimensions A/B/C mm		Weight kg/100 m	EAN code	Ref. No.
<b>Screw set 22S</b>					
Screw set to be used for installation of Ceiling bracket 5 on Pendant/fixing rails 24/34 and 24/48, Angle bracket 5L against the back of Pendant/fixing rails, Pendant/fixing rails back to back. Set including screw MVBF 8x16 and nut M6MF8. Material: Stainless steel AISI316.					
P140151 	22S	–	1.9	7321677255825	<b>725582</b>
<b>Screw set W34</b>					
Screw set to be used for mounting of Angle bracket W8 onto Pendant rail W32 and for joining of W4 Installation trays. Set including screw MSCS 6x12 and nut M6MF6. Material: Stainless steel AISI316.					
P140156 	W34	10/10/16	0.8	7321677255894	<b>725589</b>
<b>Screw set W36</b>					
Screw set including bolt and nut M8 to be used for the mounting of single Pendant attachment W21 or on Support bracket/joint W7. Material: Stainless steel AISI316.					
715646 	W36	M8	1.2	7321677255818	<b>725581</b>
<b>Screw set W37</b>					
Screw set including bolt MVBF 8x35 and nut M6MF 8, to be used for assembly of Pendant attachment W21 and Ceiling attachment W31 with Pendant rail W32, and for the joining of Pendant rail W32. Material: Stainless steel AISI316.					
716799 	W37	M8	2.8	7321677255863	<b>725586</b>
<b>T-bolt 26U</b>					
T-bolt to be used for the mounting of Cantilever arm 50 on Pendant/Fixing rail 24/48 and all vertical pieces except Vertical piece 2. Material: Stainless steel AISI316.					
T-bolt single-10 	26U M8x30	50/44/18	6.8	3606489579784	<b>CSU795596</b>
	26U M10x30	50/44/18	6.8	3606489579746	<b>CSU795592</b>
	26U M10x50	70/44/18	9.5	3606489579753	<b>CSU795593</b>

#### Threaded rods

<b>Threaded rod B41</b>					
Threaded rod according to metric standard 6G. Material: Stainless steel AISI316L.					
csu08050000 	B41/M8	8/8/1000	63	7332227015516	<b>1149551</b>
		8/8/2000	63	7332227015523	<b>1149552</b>
	B41/M10	10/10/1000	99	7332227015615	<b>1149561</b>
		10/10/2000	99	7332227015622	<b>1149562</b>
<b>Joint nut M8, M10</b>					
Joint nut to be used to connect two lengths of threaded rods B41. Material: Stainless steel AISI316.					
PTCSU0043 	Joint nut M8	40/15/13	5.0	7321677250844	<b>725084</b>
	Joint nut M10	40/18.5/16	7.2	7321677248070	<b>724807</b>
<b>Flange nut B43</b>					
Flange nut to be mounted onto Threaded rod B41 in order to lock it to the Support hook and the Ceiling fittings. Package of 50 pcs. Material: Stainless steel AISI316L.					
P140154 	B43/M8	17/17/8	34	7332227015547	<b>1149554</b>
	B43/M10	20/20/15	56	7332227015646	<b>1149564</b>

#### Cantilever arms

<b>Cantilever arm 50</b>					
Cantilever arm for mounting on walls, pendant/fixing rails or vertical pieces. Material: Stainless steel AISI316L.					
P140016 	50-100	85/40/150	24	7321677256181	<b>725618</b>
	50-150	85/40/200	28	7321677256198	<b>725619</b>
	50-200	85/40/250	34	7321677256204	<b>725620</b>
	50-300	105/40/350	60	7321677256228	<b>725622</b>
	50-400	120/50/450	118	7321677256235	<b>725623</b>
	50-500	140/50/550	172	7321677256242	<b>725624</b>
	50-600	150/50/650	215	7321677256259	<b>725625</b>



#### Vertical pieces

Type	Dimensions A/B/C mm		Weight kg/100 pcs	EAN code	Ref. No.
<b>Vertical piece 2</b>					
Vertical piece to be used with Angle bracket W8S for symmetric loading. Can be extended by using Pendant joint 2J. Material: Stainless steel AISI316L.					
2-300	279/80/135		52	7321677255573	<b>725557</b>
2-400	392/80/135		62	7321677255580	<b>725558</b>
2-500	504/80/135		72	7321677255597	<b>725559</b>
2-700	729/80/135		93	7321677255603	<b>725560</b>
2-1000	1022/80/135		120	7321677255610	<b>725561</b>
<b>Vertical piece 2F</b>					
Vertical piece to be used for installation of Cantilever arm 50. Can be joined to Pendant/fixing rail 24/48 with Pendant joint 2FJ. Material: Stainless steel AISI316L.					
2F-280	280/80/135		80	7321677255627	<b>725562</b>
2F-370	370/80/135		100	7321677255634	<b>725563</b>
2F-505	505/80/135		130	7321677255641	<b>725564</b>
2F-730	730/80/135		170	7321677255658	<b>725565</b>
2F-1000	1000/80/135		220	7321677255665	<b>725566</b>
2F-1500	1495/80/135		290	7321677872787	<b>787278</b>

#### Ceiling brackets

<b>Ceiling attachment W31</b>					
Ceiling attachment to be used for installations with Pendant rail W32. Material: Stainless steel AISI316L.					
W31	70/64/25		6.5	7321677255832	<b>725583</b>
<b>Ceiling bracket 5</b>					
Ceiling bracket to be used for installations with Pendant/Fixing rails 24/34 and 24/48. Screw not included. Material: Stainless steel AISI316L.					
5	100/135/40		35	7321677255733	<b>725573</b>

#### Pendant/Fixing rails

<b>Pendant rail W32</b>					
Pendant rail to be installed in ceilings in combination with ceiling attachment W31. Material: Stainless steel AISI316L.					
W32	3000/20/20		180	7321677255849	<b>725584</b>
<b>Pendant/Fixing rail 24/34</b>					
Pendant/Fixing rail for mounting of support brackets, cantilever arms, etc. Material: Stainless steel AISI316L.					
24/34	293/16/42		23	7321677255740	<b>725574</b>
24/34	383/16/42		31	7321677255757	<b>725575</b>
24/34	495/16/42		40	7321677255764	<b>725576</b>
24/34	698/16/42		56	7321677255771	<b>725577</b>
24/34	990/16/42		80	7321677255788	<b>725578</b>
24/34	2970/16/42		240	7321677255795	<b>725579</b>
<b>Pendant/Fixing rail 24/48</b>					
Pendant/Fixing rail for mounting of support brackets, cantilever arms, etc. Material: Stainless steel AISI316L.					
24/48	1000/26/48		175	3606481317865	<b>CSU795565</b>
24/48	2970/26/48		520	7321677285952	<b>728595</b>
24/48	5940/26/48		1120	7321677317271	<b>731727</b>

#### Pendant/Fixing rails

Type	Dimensions A/B/C mm		Weight kg/100 pcs	EAN code	Ref. No.
<b>Pendant bar 1</b>					
Pendant bar to be installed in order to reduce the deflection of heavily loaded vertical pieces. Installed with T-bolt and Expansion bolt. Material: Stainless steel AISI316L.					
1-500	515/166/40		53	3606480911415	<b>CSU795328</b>
<b>Pendant W21</b>					
Pendant attachment to be used in combination with pendant rail W32. Material: Stainless steel AISI316L.					
W21	97/50/21		12	7321677255856	<b>725585</b>

P140346



PTCSU-0010



#### Pendant joints

<b>Pendant joint 2J and 2FJ</b>					
Pendant joint to be used for joining pendant/fixing rails and vertical pieces. Screws M8x16 and nuts included. Material: Stainless steel AISI316L.					
2J	200/48/18		43	7321677264841	<b>726484</b>
2FJ	200/55/18		46	7321677264858	<b>726485</b>

P140347



P139860



#### Angle brackets

<b>Angle bracket W8</b>					
Angle bracket to be mounted inside a cable tray W4 for horizontal installation to the wall or vertical installation to the floor. Can also be mounted as a pendant bracket in the W4 installation tray. Material: Stainless steel AISI316L.					
W8	80/38/45		6	7321677255801	<b>725580</b>
<b>Angle bracket W8S</b>					
Universal angle bracket to be used for various installations of pendant/fixing rail 24/34, support bracket, etc. Material: Stainless steel AISI316L.					
W8S	120/30/30		8	7321677268757	<b>726875</b>

PTCSU-0011



PTCSU-0012



#### End plugs

<b>End plug 28C and E</b>					
End plug to be mounted on pendant ends to provide protection against personal injury and to make the ends of the profiles more conspicuous. Material: PP/TPE, orange.					
28C for Vertical piece 2 and Pendant/fixing rail 24/34	25/19/46		0.5	7321677898756	<b>789875</b>
28E for Vertical piece 2F and Pendant/fixing rail 24/48	24/30/52		0.5	7321677090211	<b>709021</b>

P140067



P140069



#### Protection strip

<b>Protection strip W48</b>					
Protection strip to be used to protect cables from sharp edges when cutting the cable tray W4. Material: Plastic.					
W48	10/6/720		6.1	7321677872114	<b>787211</b>

PTCSU-0013



Installation instructions

# Use and Installation

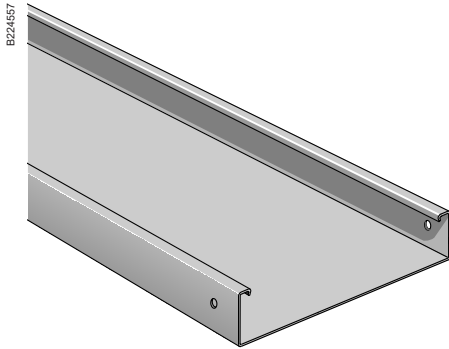

### Cable tray W1/40, unperforated

Unperforated cable tray system height 40 mm. Provided with holes  $\varnothing 5.8$  mm at the tray end to be used for fixation of joints.

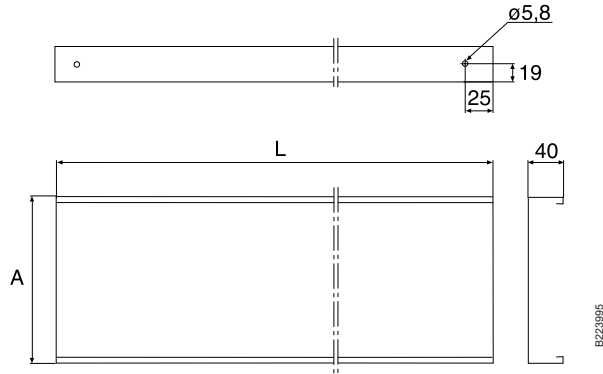

#### Cable tray W1 H=40 mm L=2000 mm

F1: End span, the joint position is in mid span

F2: Center span

One or more joints may be required dependent upon the product length and span.

#### Span 2 m

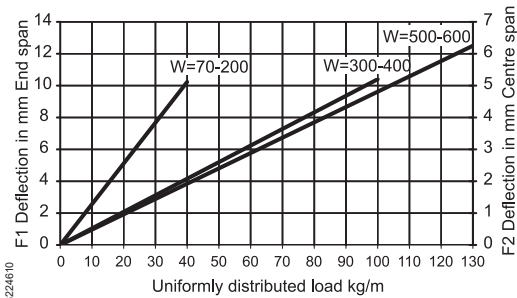
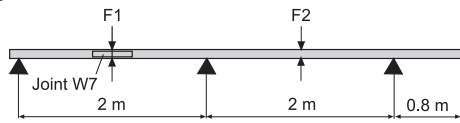

Type	A mm	L mm
Cable tray W1/40-70	70	2000
Cable tray W1/40-100	100	2000
Cable tray W1/40-200	200	2000
Cable tray W1/40-300	300	2000
Cable tray W1/40-400	400	2000
Cable tray W1/40-500	500	2000
Cable tray W1/40-600	600	2000
Cable tray W1/40-500 FS	500	2000
Cable tray W1/40-600 FS	600	2000
Cable tray W1/40-70	70	3000
Cable tray W1/40-100	100	3000
Cable tray W1/40-200	200	3000
Cable tray W1/40-300	300	3000
Cable tray W1/40-400	400	3000
Cable tray W1/40-500	500	3000
Cable tray W1/40-600	600	3000

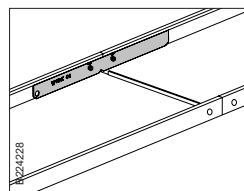

Cable tray W1/40 is joined with 2 Side joints W49/40 or Support bracket/joint W7/40.

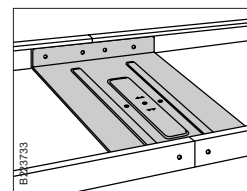

For trays 300 mm and wider we recommend to use Support bracket/joint W7/40.

### Cable tray W1/60, unperforated

Unperforated cable tray system height 60 mm. Provided with holes  $\varnothing 5.8$  mm at the tray end to be used for fixation of joints.

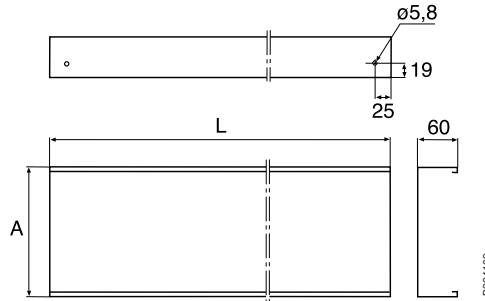
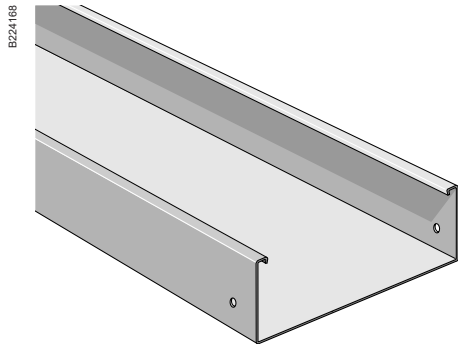

#### Cable tray W1 H=60 mm L=2000 mm

F1: End span, the joint position is in mid span

F2: Center span

One or more joints may be required dependent upon the product length and span.

#### Span 2 m

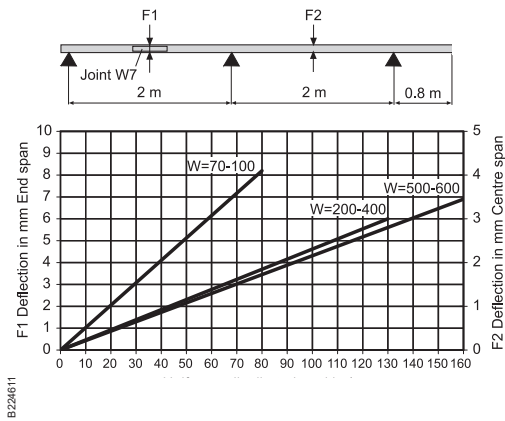

Type	A mm	L mm
Cable tray W1/60-70	70	2000
Cable tray W1/60-100	100	2000
Cable tray W1/60-200	200	2000
Cable tray W1/60-300	300	2000
Cable tray W1/60-400	400	2000
Cable tray W1/60-500	500	2000
Cable tray W1/60-600	600	2000
Cable tray W1/60-500 FS	500	2000
Cable tray W1/60-600 FS	600	2000

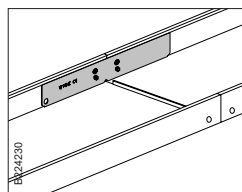

Cable tray W1/60 is joined with 2 Side joints W49/60 or Support bracket/joint W7/60.

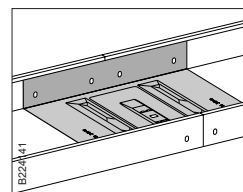

For trays 300 mm and wider we recommend to use Support bracket/joint W7/60.

### Cable tray W3/40, perforated

Perforated cable tray system height 40 mm. Provided with holes  $\varnothing 5.8$  mm at the tray end to be used for fixation of joints. Oval holes along the lateral side of the tray can be used for mounting of accessories.

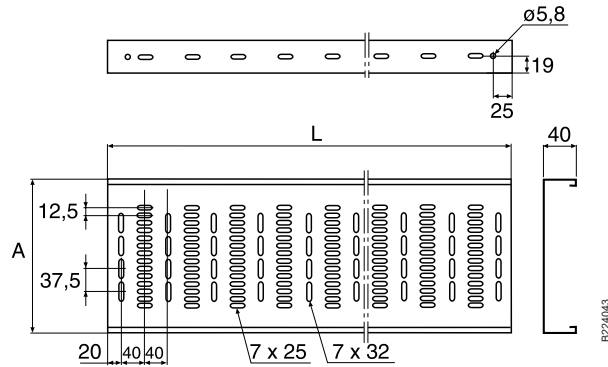
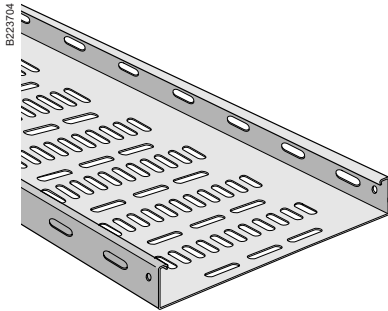

Span 1.5 m

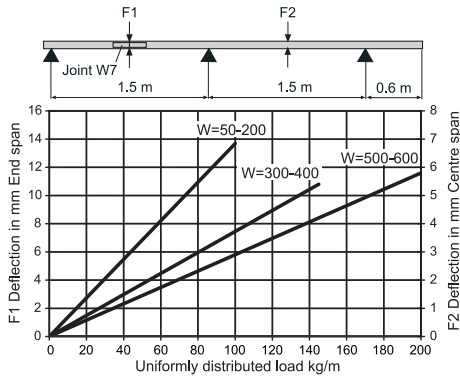

Type	A mm	L mm
Cable tray W3/40-50	50	3000
Cable tray W3/40-70	70	3000
Cable tray W3/40-100	100	3000
Cable tray W3/40-150	150	3000
Cable tray W3/40-200	200	3000
Cable tray W3/40-300	300	3000
Cable tray W3/40-400	400	3000
Cable tray W3/40-500	500	3000
Cable tray W3/40-600	600	3000

Span 2 m

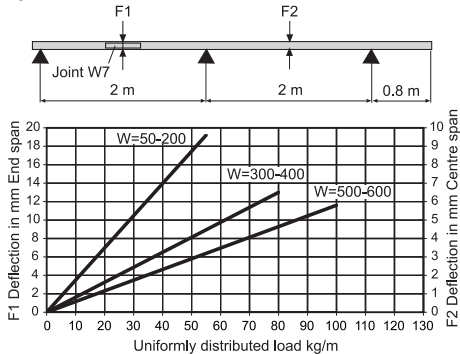

Span 2.5 m

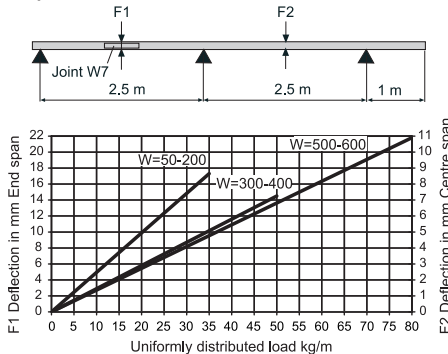

The cable trays are tested according to IEC 61537:  
**Cable tray W3 H=40mm**  
**L=3000mm**

F1: End span, the joint position is in mid span  
 F2: Center span  
 One or more joints may be required dependent upon the product length and span.

Span 3 m

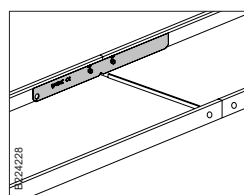
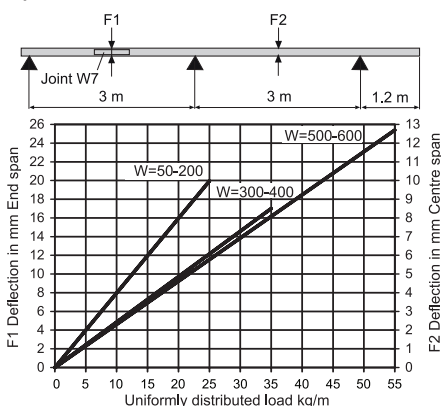

Cable tray W3/40 is joined with 2 Side joints W49/40 or Support bracket/joint W7/40.

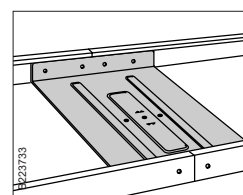

For Pre-galvanized trays 300 mm and wider we recommend to use Support bracket/joint W7/40.

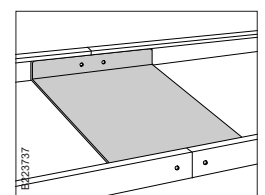

For Hot dip galvanized trays 300 mm and wider we recommend to use Joint W7/40.



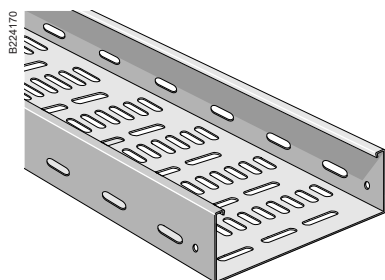

### Cable tray W3/60, perforated

Perforated cable tray system height 60 mm. Provided with holes  $\varnothing 5.8$  mm at the tray end to be used for fixation of joints. Oval holes along the lateral side of the tray can be used for mounting of accessories.

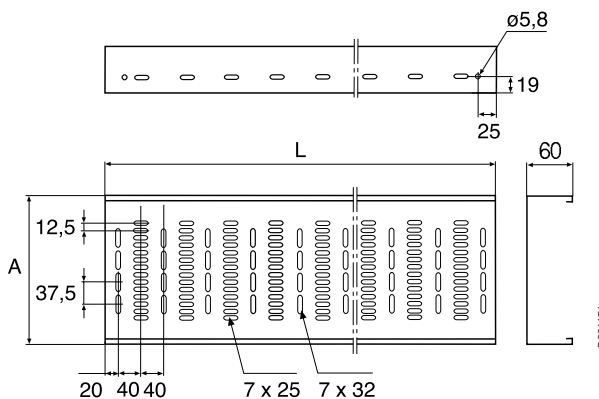

#### Cable tray W3 H=60 mm L=3000 mm

F1: End span, the joint position is in mid span

F2: Center span

One or more joints may be required dependent upon the product length and span.

#### Span 2 m

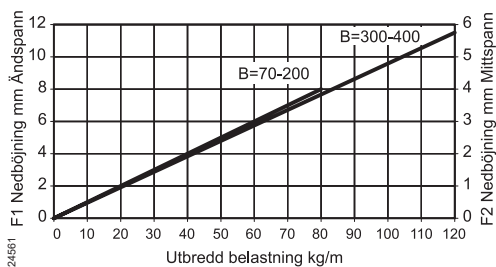
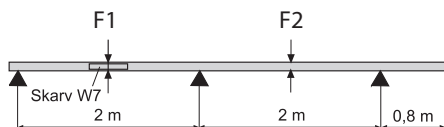

Type	A mm	L mm
Cable tray W3/60-70	70	3000
Cable tray W3/60-100	100	3000
Cable tray W3/60-150	150	3000
Cable tray W3/60-200	200	3000
Cable tray W3/60-300	300	3000
Cable tray W3/60-400	400	3000
Cable tray W3/60-500	500	3000
Cable tray W3/60-600	600	3000

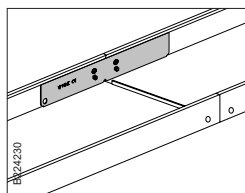

Cable tray W1/60 is joined with 2 Side joints W49/60 or Support bracket/joint W7/60.

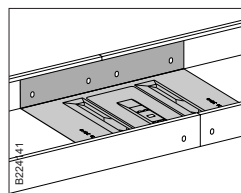

For trays 300 mm and wider we recommend to use Support bracket/joint W7/60.

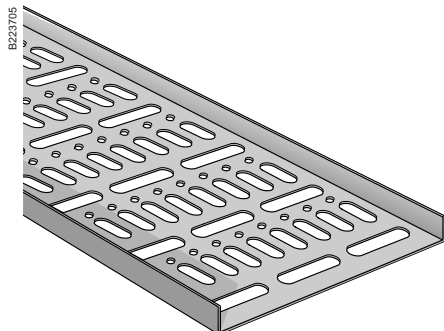

### Installation tray W4

Perforated installation tray. To be used when leading cables down from a cable ladder to machine cabinets, etc. Provided with holes  $\varnothing 3.5$  mm in the bottom segment of the tray for the clamping of cables with plate screws.

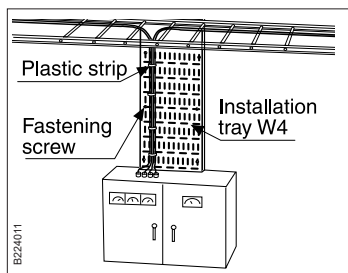
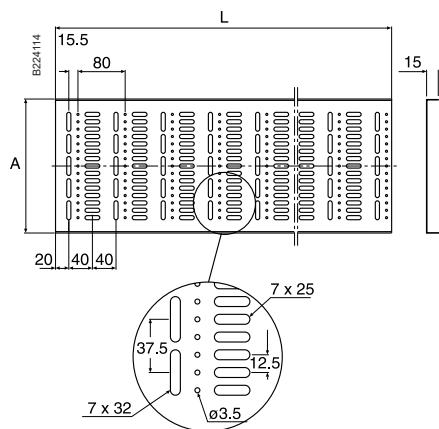

Type	L mm	A m
W4-50	1960	50
	3000	
W4-75	1960	75
	3000	
W4-100	1960	100
	3000	
W4-150	1960	150
	3000	
W4-200	1960	200
	3000	
W4-250	1960	250
	3000	
W4-300	1960	300
	3000	
W4-400	1960	400
	3000	

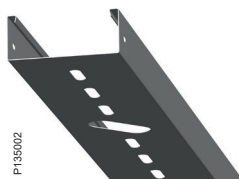

P135002

### Lighting trunking W70

Cable tray with bottom perforation. System height 40 mm, length 3000 mm. Oval holes 9x6 mm on the lateral sides of the tray end can be used for fixation of joints. The oval hole pattern at the base of the tray can be used for mounting of lighting fixtures. On every 500 mm an oval hole is placed to easily guide fast connectors into the tray. In the wider trays with widths from 70 to 200 the hole is turned 45°.

Description	A mm
Lighting trunking W70-50	50
Lighting trunking W70-70	70
Lighting trunking W70-100	100
Lighting trunking W70-200	200

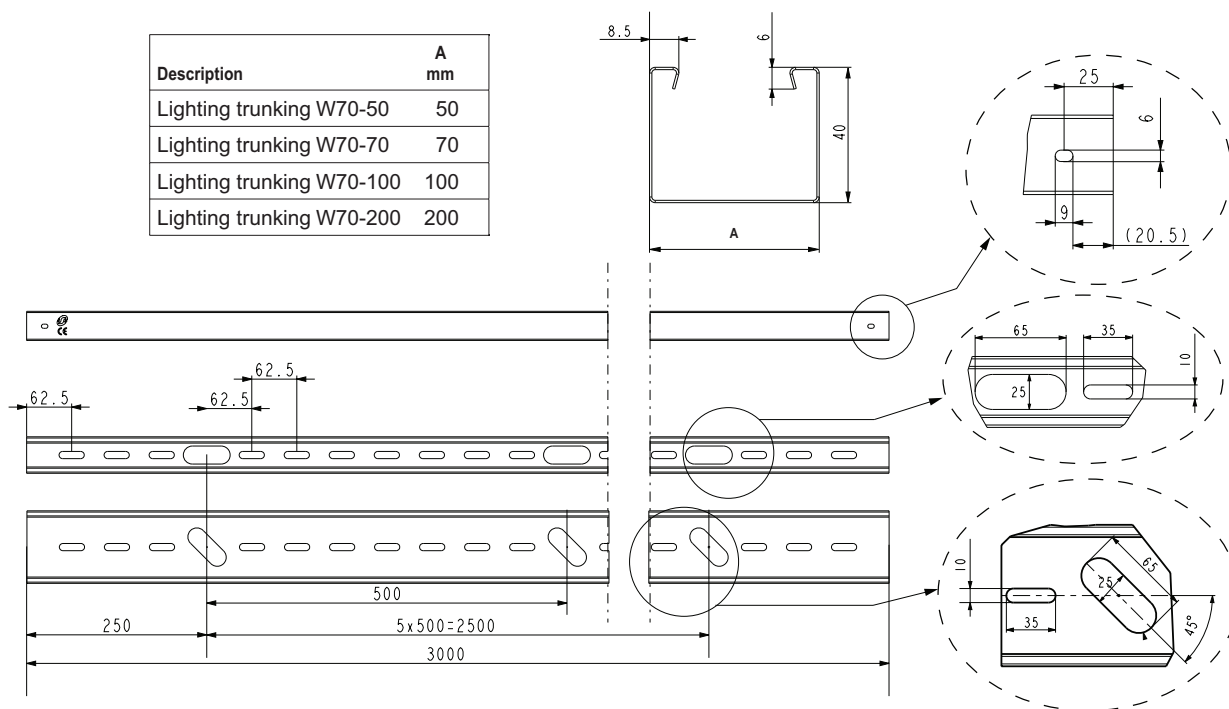

#### Loading capacity

Load test executed according to IEC 61537  
 F1 represent deflection in section with joint  
 F2 represent deflection in section without joint

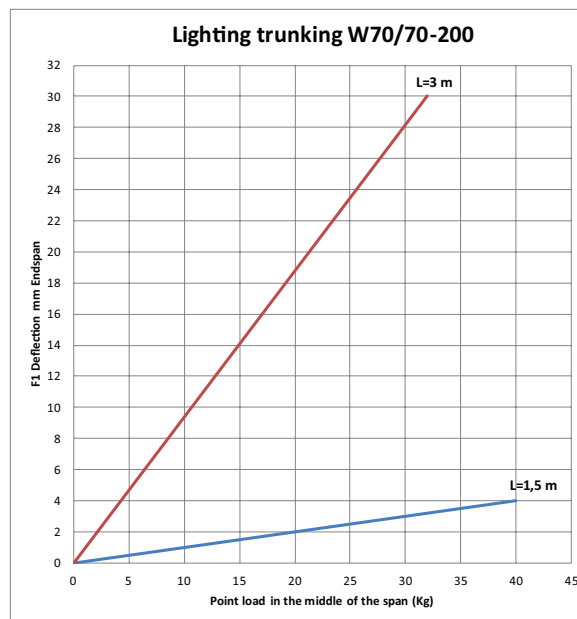
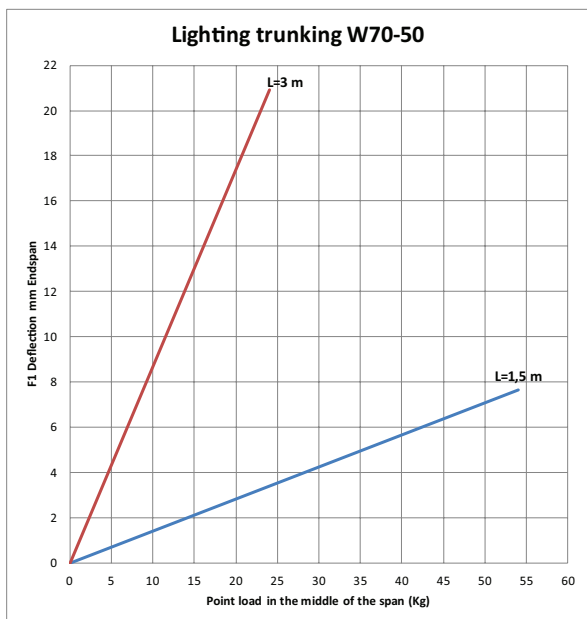
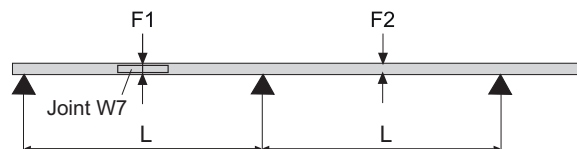

Breaking load for Joint W7/40-70 = 120 kg

### Cover W5

Cover to be used to protect the cables inside the cable tray against damages, dust, liquids, UV-influence, etc.

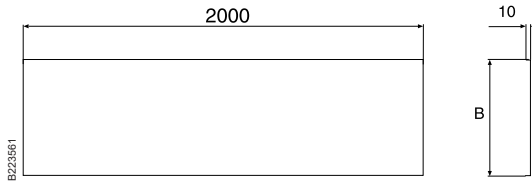
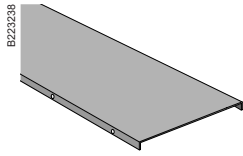

Type	B mm
Cover W5 - 70	71
Cover W5 - 100	101
Cover W5 - 150	151
Cover W5 - 200	201
Cover W5 - 300	301
Cover W5 - 400	401
Cover W5 - 500	501
Cover W5 - 600	601

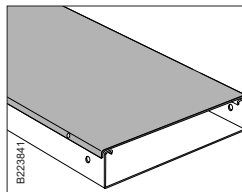

Used for screening of control cables and in dusty and dirty premises.

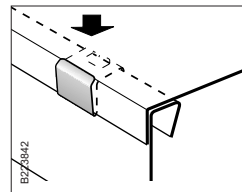

Covers must be mounted on cable trays with Cover clamp W62.

### Cover clamp W62

Used for fixing covers on Trays W1 and W3 as well as on Lighting trunking W70.

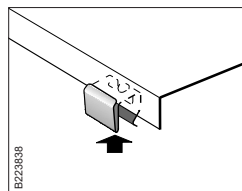
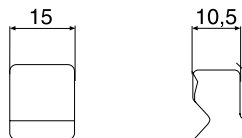
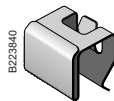

Cover clamp W62 is used for fixing the covers on Cable tray W1 and W3 as well as on Lighting trunking W70/71.

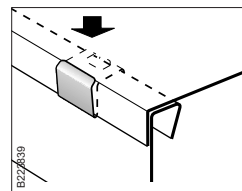

Start by pressing the Cover clamp W62 over the sides of the cover. Then snap the cover over the folded edges of the tray. 6 Cover clamps W62 are needed per cover.

### CLX<sup>3</sup> General information

#### Standards

CLX<sup>3</sup> installation system is tested and following the classification according to the IEC 61537.



#### Usage of gloves

According to IEC 61537 it is always recommended to use protective gloves when handling and manipulating cable support systems.

#### Handling and storage

- Store in dry and covered places.
- Avoid moisture and pollutants.
- Do not remove the packing until installation.
- Take care when storing and handling so that the CLX<sup>3</sup> components are well protected from damage.

#### CLX<sup>3</sup> Pendant loading configurations

CLX<sup>3</sup> pendant is primarily designed for installation of the CLX<sup>3</sup> support system, but can also be used for T-bolt installation.

The system can be installed in different configurations:

- Click direction (1): the cantilever and the ceiling plate are in the same direction
- T-bolt direction (2): a cantilever is fixed with a T-bolt to the rail, in the opposite direction of the ceiling plate
- T installation (3): combination of the first 2 installations
- Central suspension (4): the pendant is completed by a central suspension bracket
- T and central suspension (5).

P148210

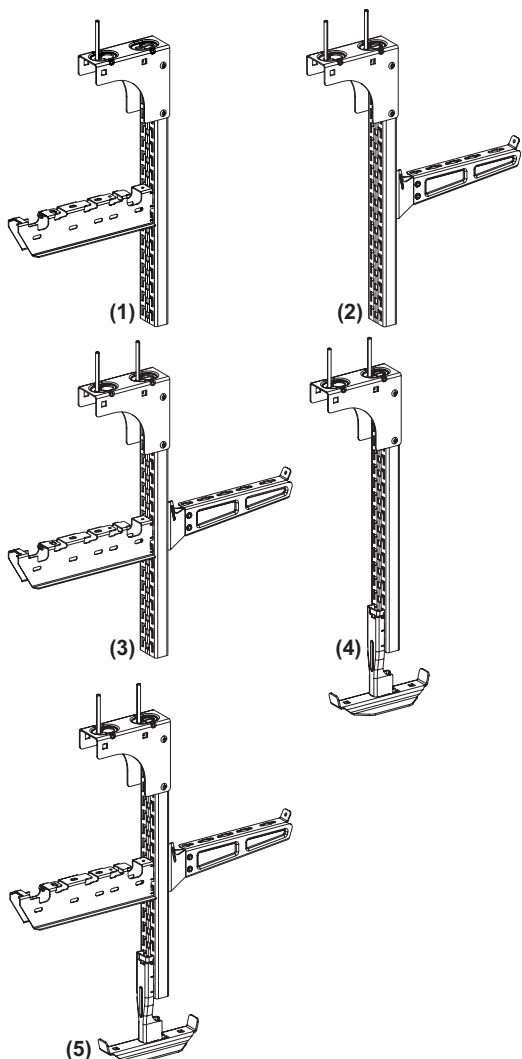

#### Fixation to the ceiling

##### Keyhole design

Keyhole design is facilitating easy mounting of the pendant to the ceiling by allowing the bolts to be pre-fixed before finally placing the pendant and tightening the bolts.

For concrete ceiling, use bolts type IMT38051.

For other bolts where bolthead is < 16 mm use washer ≥ 16 mm.

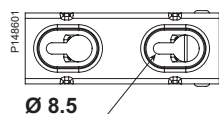

##### One bolt fixation

For click direction installation of CLX<sup>3</sup> Cantilever arm (1), use a single bolt, in the outer hole position on the ceiling plate.

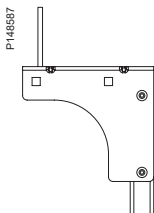

##### Two bolt fixation

For T-bolt suspension, central suspension, T installation and T and central suspension installation (2), (3), (4), (5), always fix the ceiling plate to the ceiling using 2 bolts.

Use the angle adaptor when the ceiling is not horizontal to level out the suspended pendant.

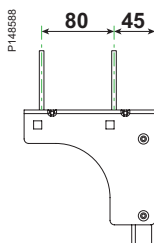

### Pendant load calculation

To verify that the load applied to each pendant is within performance, it is necessary to calculate and consolidate the total **tensile load force** and the total **moment-force** on each pendant and for each cantilever and after that compare the calculated values with the defined loading limitations to ensure a safe installation.

#### Total tensile force **Ft** calculation method

This is calculated as the sum of all forces applied to the pendant from the weight of cables on the length material.

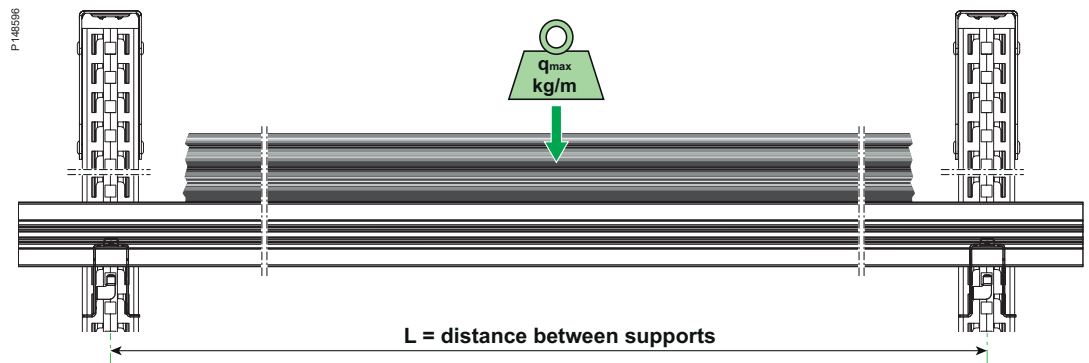

$F_t$  (total load in N) = L (span or supports distance in meters) x  $q_{max}$  (load in kg/m) x 10.

In case of several layers are installed on the pendant then the sum of the  $F_t$  tensile load from all layers shall be calculated.

#### Total momentum force **Mt** calculation method

This is calculated as the sum of all the torsion forces applied to the pendant from the weight of cables on the length material and the offset distance created by the cantilever arm.

$M_t$  (momentum in N.m) =  $F_t$  (N) x  $d$  (distance between axis center and point load in meters)

“ $d$ ” depends of the position of the length material on the cantilever arm.

The distance  $d$  can be different depending on installation method.

When the length material is installed on the full width of the cantilever, use  $d_1$ .

For length material that are installed at the outer end of the arm, use  $d_2$ .

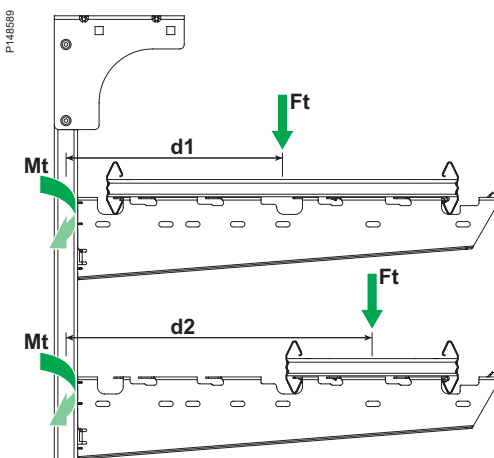

Model	PG	d1 (m)	d2 (m)
CLX <sup>3</sup> cantilever arm 100	CSU795645	0.09	Na
CLX <sup>3</sup> cantilever arm 150	CSU795646	0.110	
CLX <sup>3</sup> cantilever arm 200	CSU795647	0.140	
CLX <sup>3</sup> cantilever arm 300	CSU795648	0.190	
CLX <sup>3</sup> cantilever arm 400	CSU795649	0.240	0.340
CLX <sup>3</sup> cantilever arm 500	CSU795650	0.290	0.440
CLX <sup>3</sup> cantilever arm 600	CSU795651	0.340	0.490

In case of several layers are installed on the pendant then the sum of the  $M_t$  momentum force from all layers shall be calculated.



Ensure that the installation is designed so that  $\Sigma M_t$  and  $\Sigma F_t$  are under the limits.



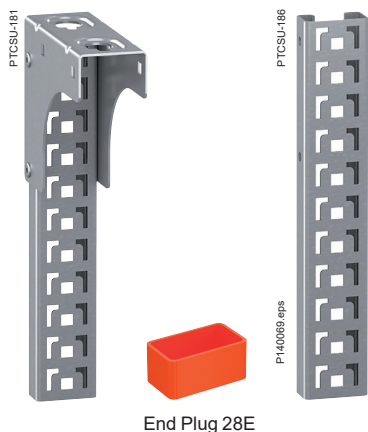

End Plug 28E

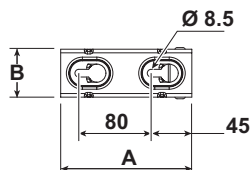
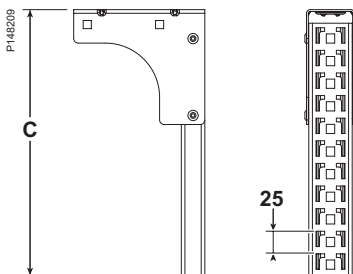
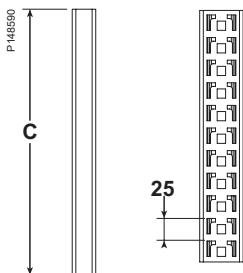

### CLX<sup>3</sup> Pendant 24/48

Vertical piece with a perforated pattern to be used for installation of CLX<sup>3</sup> cantilever arms or CLX<sup>3</sup> central suspension adapter. The open side of the rail can be used for installation of cantilever arms and brackets together with T-bolt.

Can be joined to CLX<sup>3</sup> Rail 24/48 with pendant joint 2FJ.

Model	PG	High (mm) A	Width (mm) B	Length (mm) C
<b>CLX<sup>3</sup> pendant</b>				
CLX <sup>3</sup> pendant 24/48 300 mm PG	CSU795632	145	53	295
CLX <sup>3</sup> pendant 24/48 400 mm PG	CSU795633			395
CLX <sup>3</sup> pendant 24/48 500 mm PG	CSU795634			495
CLX <sup>3</sup> pendant 24/48 700 mm PG	CSU795635			695
CLX <sup>3</sup> pendant 24/48 1000 mm PG	CSU795636			995
CLX <sup>3</sup> pendant 24/48 1500 mm PG	CSU795638			1495
<b>CLX<sup>3</sup> rail</b>				
CLX <sup>3</sup> rail 24/48 300 mm PG	CSU795640	26	48	280
CLX <sup>3</sup> rail 24/48 1000 mm PG	CSU795641			980
CLX <sup>3</sup> rail 24/48 3000 mm PG	CSU795637			2980

### Pendants Safe Working Load (SWL)

SWL for bending moment of the pendant **Mt**.

Model	PG	Moment (N.m) Click side	Deflection (mm)
CLX <sup>3</sup> pendant 24/48 300 mm PG	CSU795632	235	2
CLX <sup>3</sup> pendant 24/48 400 mm PG	CSU795633		4
CLX <sup>3</sup> pendant 24/48 500 mm PG	CSU795634		7
CLX <sup>3</sup> pendant 24/48 700 mm PG	CSU795635		15
CLX <sup>3</sup> pendant 24/48 1000 mm PG	CSU795636		30
CLX <sup>3</sup> pendant 24/48 1500 mm PG	CSU795638	200	30

Tested according to IEC 61537 standard.

### SWL bending moment for Adjustable ceiling plate **Mt**.

Model	PG	Moment (N.m) Click side
CLX <sup>3</sup> adjustable ceiling plate	CSU795639	235

### SWL pendant tensile strength **Ft**.

Model	PG	Tensile load SWL (N) 1 bolt CLX <sup>3</sup>	Tensile load SWL (N) 2 bolts CLX <sup>3</sup>
CLX <sup>3</sup> pendant 24/48 300 mm PG	CSU795632	2000	5000
CLX <sup>3</sup> pendant 24/48 400 mm PG	CSU795633		
CLX <sup>3</sup> pendant 24/48 500 mm PG	CSU795634		
CLX <sup>3</sup> pendant 24/48 700 mm PG	CSU795635		
CLX <sup>3</sup> pendant 24/48 1000 mm PG	CSU795636		
CLX <sup>3</sup> pendant 24/48 1500 mm PG	CSU795638		

#### Pendant limits, torque and deflection

In the diagram below it is possible to check if  $\Sigma Mt$  is below the momentum limitation of the pendant (end of line). It is also possible to see the deflection on the pendant at max  $\Sigma Mt$  and all values below.

#### Calculation example

For a cantilever size 600, full size ladder installation, 3 m span, load of 23 kg/m on a 1000 mm pendant.

1)  $\Sigma F$ : 3 m (span) x 23 kg/m (load) x 10 = 690 N will be the load for each pendant system.

2)  $\Sigma Mt$ : 690 (N) x 0.34 (m) = 234 N.m.

$\Sigma F = 690 \text{ N} \leq 2000 \text{ N}$  and  $\Sigma Mt = 234 \text{ Nm} \leq 235 \text{ N.m}$ .

3) Drawing of the lines on the graph: for 234 N.m, the deflection on the pendant is 30 mm.

P148666

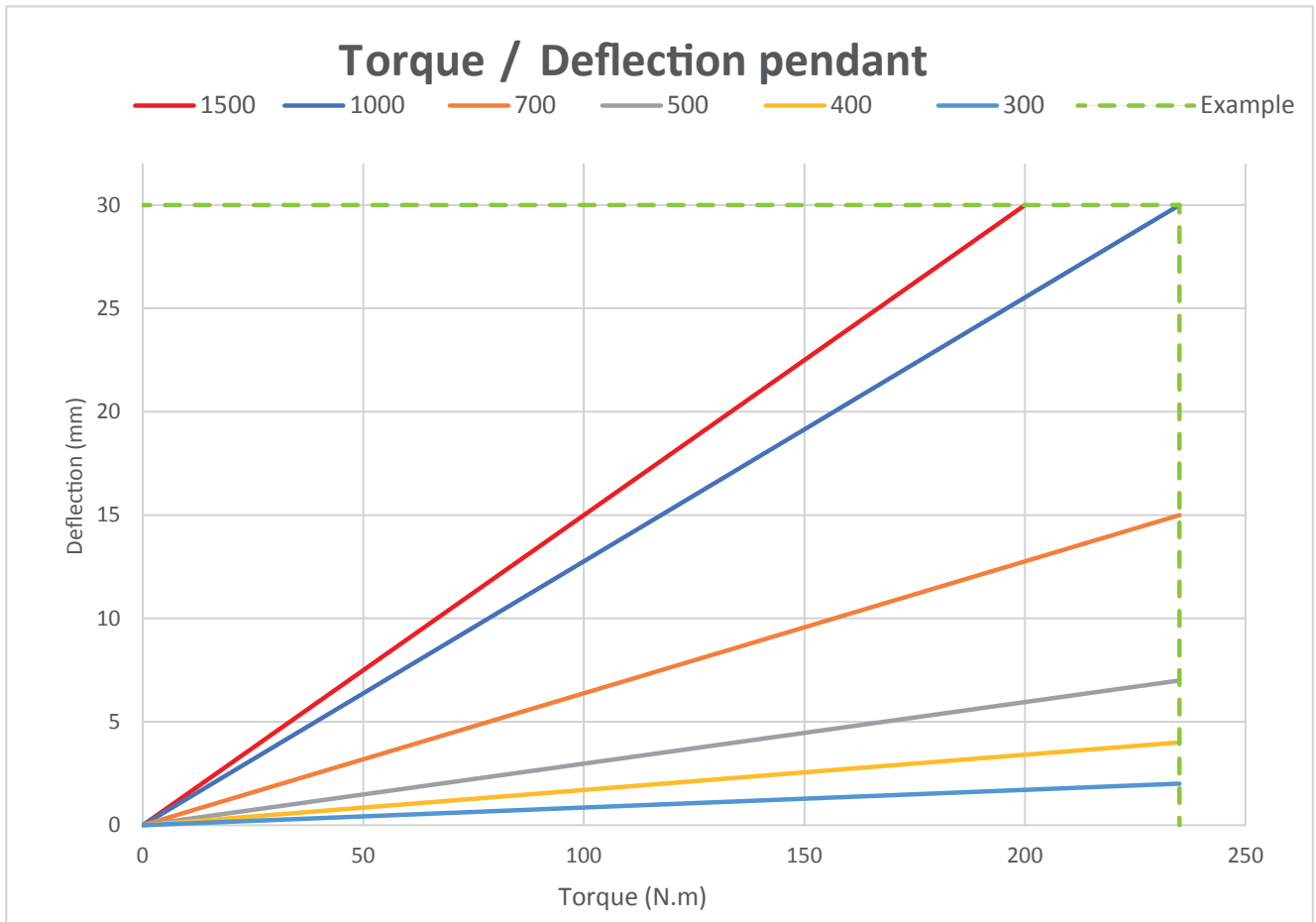

# Technical information

## Use and installation

### CLX<sup>3</sup> Click suspension

#### Distance between rails and offset

CLX<sup>3</sup> rail have a pitch between the patterns of 25 mm.

The support distance between the pendants should be at least than 1.5 m. If the length material can't be installed on the exact same level, the length material should be installed on the closest offset- pitch and never at more than 12.5 mm vertically from the previous pattern.

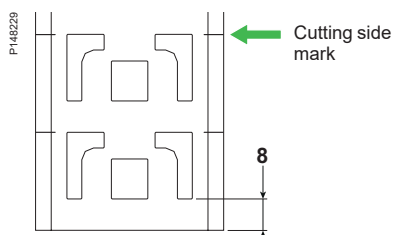
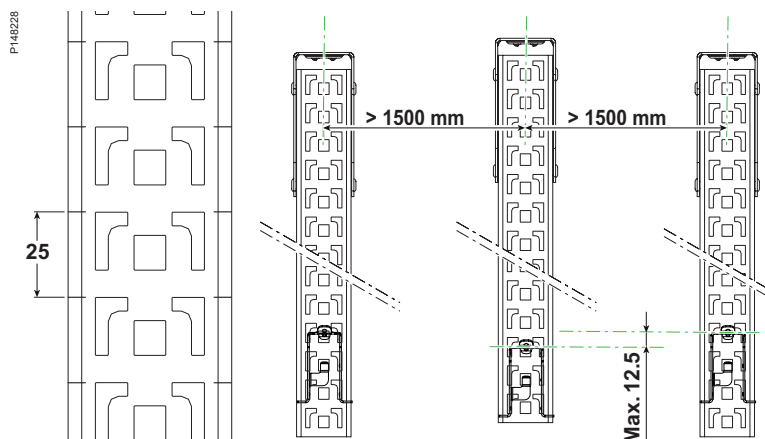

#### Cutting of the pendant or rail

Cutting of the rail or the pendant should be made at 8 mm under the last pattern needed, as the side marks are showing. This to assure that there is enough material below the bottom pattern to secure proper fixation of the cantilever arm.

#### Installation of the rail joint

CLX<sup>3</sup> rails can be joined together with pendant joint 2FJ.

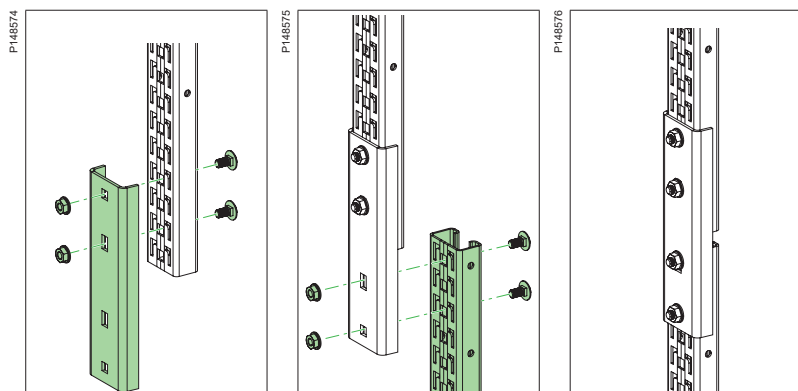

Place the joint on the rail in place, make sure the 2 top holes are in front of slots to install the included bolts and nuts.

Install the second rail as high as possible and install the other bolts and nuts.

Torque of the nuts **11 N.m.**

**Note:** extending the pendant with the rail joint will decrease the load capacity of the pendant. For SWL information when extending the pendants, contact Technical support.

PTCSU-187



### CLX<sup>3</sup> Adjustable ceiling plate

Adjustable ceiling plate is used together with CLX<sup>3</sup> pendant to allow for angle correction up to 25°. The adjustable ceiling plate is fixed to the CLX<sup>3</sup> pendant with 4 screw set 22S to be ordered separately. The pendant can be fixed to the adjustable ceiling plate in both possible directions (1) and (2).

Model	PG	High (mm) A	Width (mm) B	Length (mm) C
CLX <sup>3</sup> adjustable ceiling plate PG	CSU795639	100	59	150

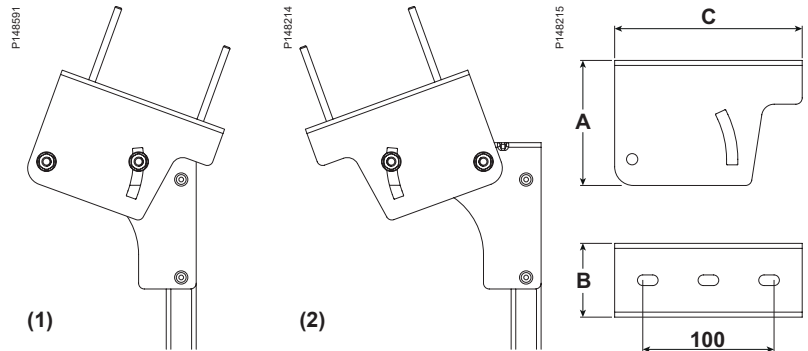

### Installation of the adjustable ceiling plate

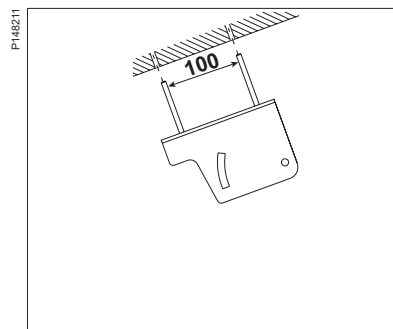

Fix the adjustable ceiling plate to the ceiling with 2 bolts.  
(c-c: 100 mm).

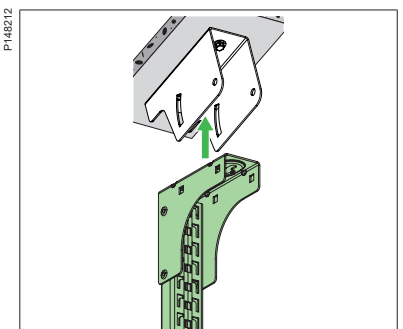

Insert the pendant into the adjustable ceiling plate.

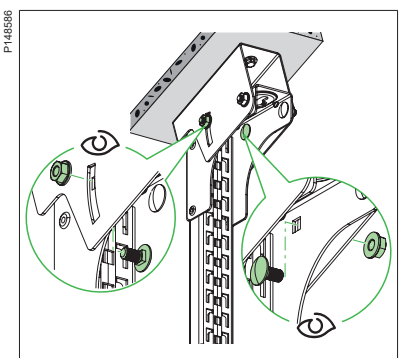
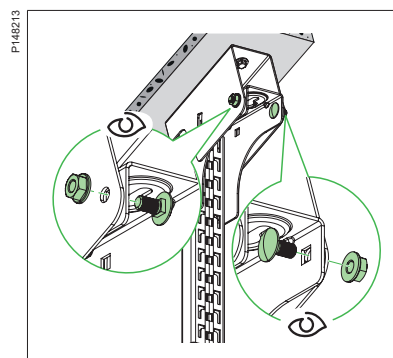

Fix the pendant to the adjustable ceiling plate with 4 bolt sets 22S and align the pendant to the vertical plane before tightening the bolts.  
**Recommended torque 20 N.m.**

PTCSU-190



### CLX<sup>3</sup> Central suspension adapter

The CLX<sup>3</sup> central suspension adapter is clicked together with the central suspension brackets to create a central suspension piece that can be clicked to the rail or pendant.

Model	PG	High (mm) A	Width (mm) B	Length (mm) C
CLX <sup>3</sup> Central suspension adapter PG	CSU795700	166	31	39

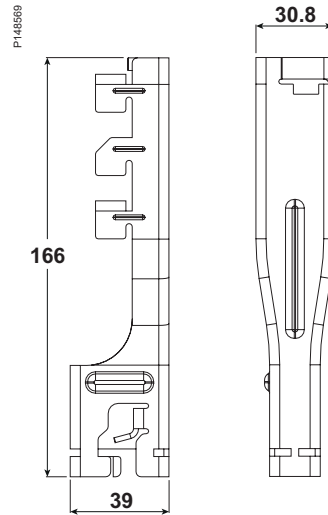

PTCSU-195



### CLX<sup>3</sup> Cable tray H40 central suspension

Bracket to be used for central suspension of Wibe cable trays, height 40.

The bracket shall be used together with the CLX<sup>3</sup> central suspension adapter.

Model	PG	High mm A	Width mm B	Length mm C
CLX <sup>3</sup> Tray H40 central suspension 70 PG	CSU795653	152	37	66
CLX <sup>3</sup> Tray H40 central suspension 100 PG	CSU795654	152	37	96

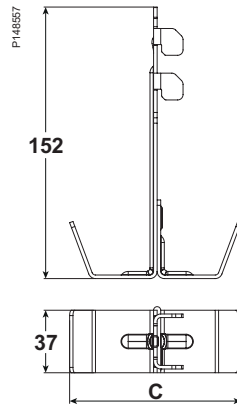

PTCSU-197



Model	PG	High mm A	Width mm B	Length mm C
CLX <sup>3</sup> Tray H40 central suspension bracket 200 PG	CSU795660	36	76	196
CLX <sup>3</sup> Tray H40 central suspension bracket 300 PG	CSU795661	36	76	296
CLX <sup>3</sup> Tray H40 central suspension bracket 400 PG	CSU795662	36	76	396
CLX <sup>3</sup> Tray H40 central suspension bracket 500 PG	CSU795663	36	76	496
CLX <sup>3</sup> Tray H40 central suspension bracket 600 PG	CSU795664	36	76	596

Tray H40 central suspension bracket	SWL symmetric load (N)
70	1000
100	800
200	1500
300	1500
400	1500
500	1250
600	1200

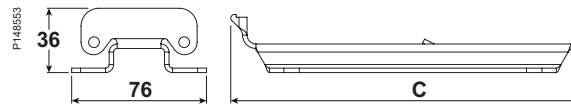



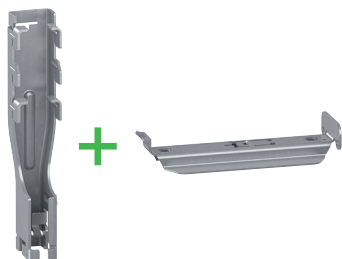

#### Installation of adaptor to central suspension brackets

The CLX<sup>3</sup> central suspension bracket is installed without tools by clicking it to the central suspension. The method is the same for Central suspension bracket ladder-mesh or -tray. In the illustration below, the CSB for ladder is used.

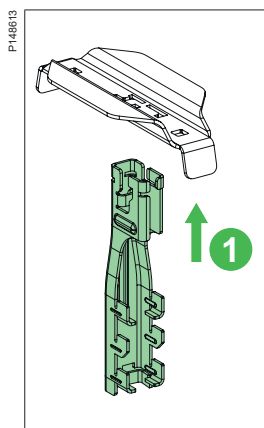

1 Insert the adaptor in the pattern on the central suspension bracket.

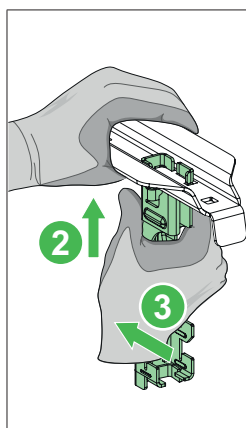

2 Press the pieces together and 3 slide the adaptor until the click lip of the adaptor pass over the locking lip of the central suspension bracket with a 4 click.

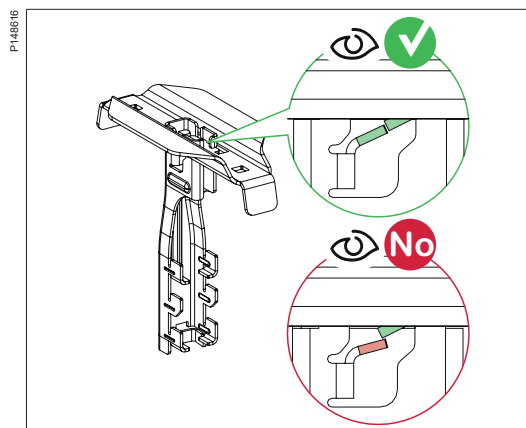
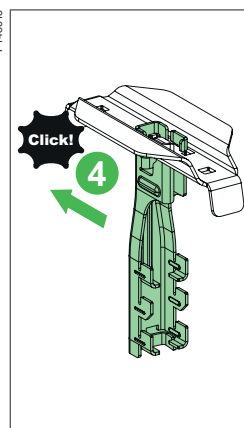

Visually check and secure that the adaptor is properly positioned, and the click lip has overpassed the locking lip.

#### Installation of central suspension adaptors to the CLX<sup>3</sup> rail

The CLX<sup>3</sup> central suspension adaptors is installed to the rail without tools, by clicking. To ensure proper installation a hooks must be inserted in the rail:

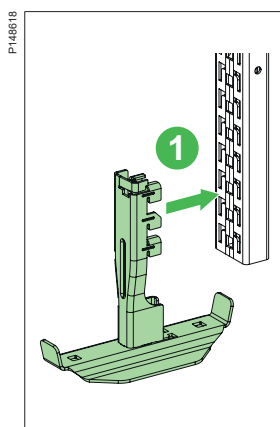

1 Push the central suspension piece until the hooks are fully inserted in the pattern and the surface touches the rail.

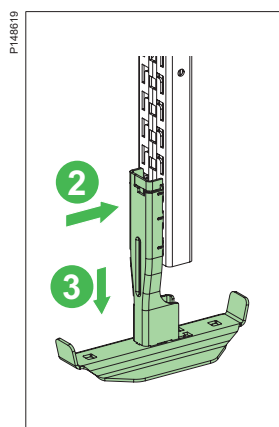

2 Press towards the rail and 3 pull down until the click lip.

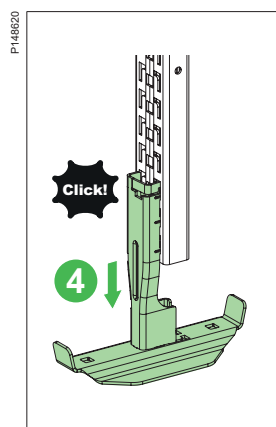

4 Pass inside the slot in the rail.

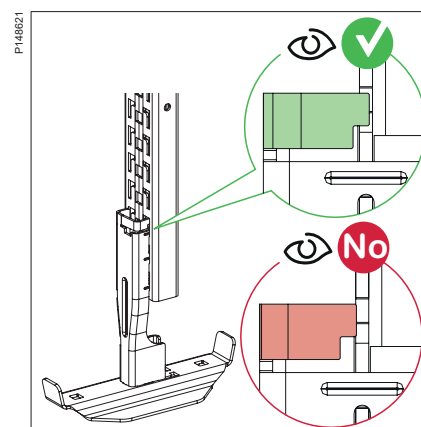

Visually check and secure that the adaptor is properly positioned, and the click lip is properly positioned inside of the slot of the CLX<sup>3</sup> rail.



Apply caution with unintended upward movements as it can cause the adaptor to unlock and therefore be released from the rail

#### Uninstallation of adapter from the CLX<sup>3</sup> rail

CLX<sup>3</sup> central suspension adapters can be removed, by using a flat screwdriver.

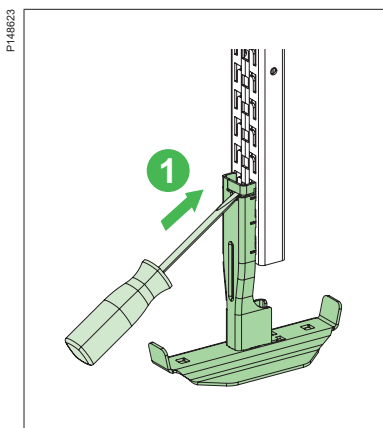

**1** Fit the screwdriver's head in the slot of the adapter.

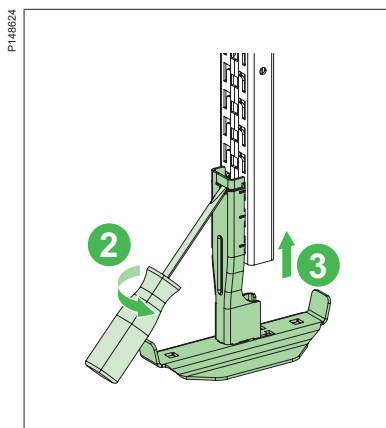

Use the screwdriver as a lever to **2** gently release the click lip from the rail. Then **3** push the adaptor up to release the L hooks from the rail.

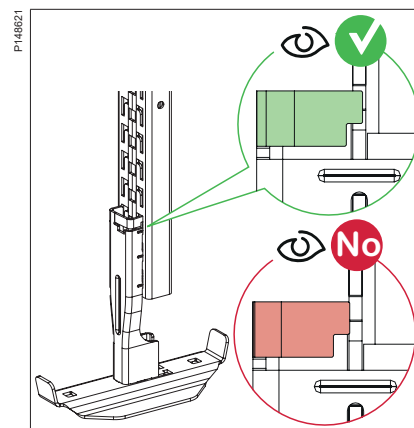

If the adapter needs to be reinstalled, correct the click lip to the initial position and make sure the click lip is locking properly.

#### Uninstallation of adaptor from central suspension brackets

CLX<sup>3</sup> central suspension brackets can be removed, by using a flat screwdriver.

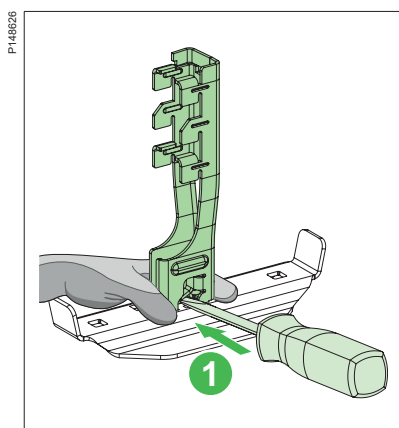

**1** Hold the bracket, fit the screwdriver's head between the adaptor lip and the bracket.

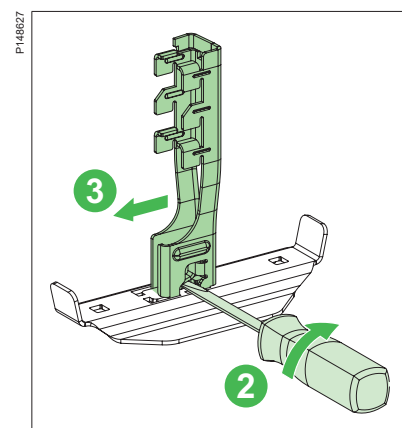

**2** Twist the screwdriver to use it as a lever on the click lip until it passes over the bracket's locking lip and **3** pull the adaptor sideways to release it.

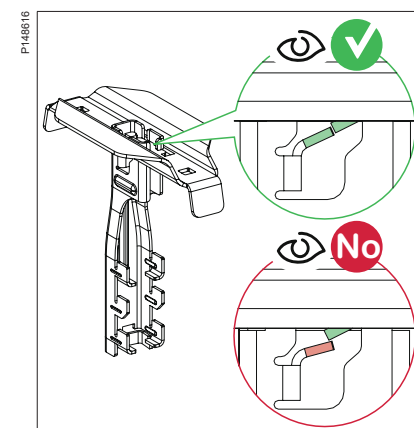

When the bracket needs to be reinstalled, correct the click lip to the initial position and make sure the click lip is locking properly.



#### Installation of Wibe H40 cable trays on central suspension bracket

CLX<sup>3</sup> central suspension bracket for Wibe cable tray H40, 70 and 100 width is installed to the rail without tools, by clicking.

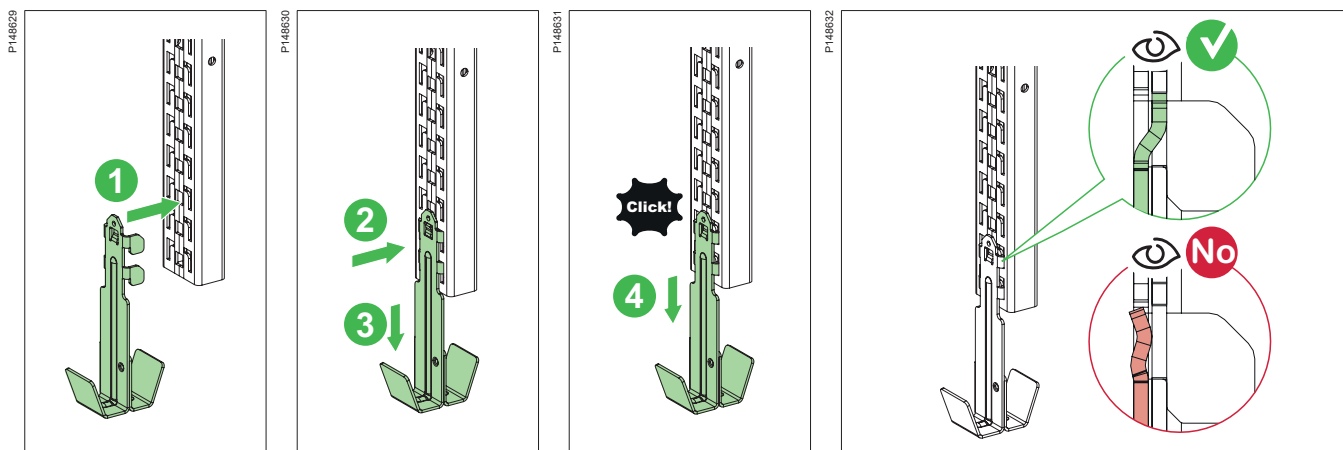

**1** Press the piece until the hooks are fully inserted in the pattern and the surface touches the rail.

**2** Press towards the rail and **3** pull down until the click lip.

**4** Pass inside the slot in the rail.

Visually check and secure that the bracket is properly positioned, and the click lip is positioned inside the slot in the CLX<sup>3</sup> rail.



Apply caution with unintended upward movements as it can cause the bracket to unlock and therefore be released from the rail

#### Uninstallation of Wibe H40 central suspension bracket from the CLX<sup>3</sup> rail

CLX<sup>3</sup> central suspension brackets can be removed, by using a flat screwdriver.

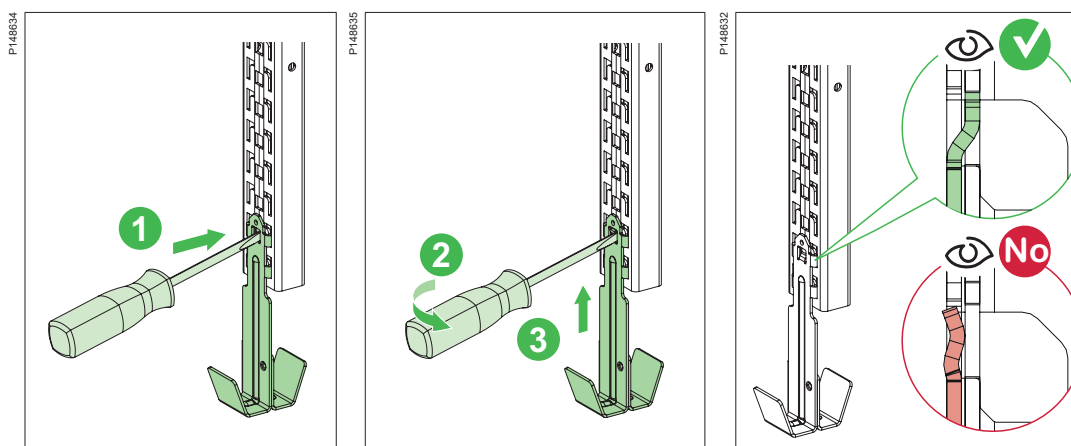

**1** Fit the head of screwdriver on the side of the locking lip.

**2** Use the screwdriver as a lever to gently bend the lip. **3** Push the bracket upwards.

When the bracket needs to be reinstalled, correct the click lip to the initial position and make sure the click lip is locking properly.

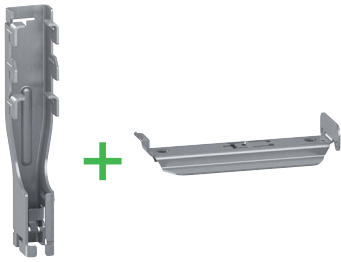

#### Installation of Wibe H40 cable trays on central suspension bracket

CLX<sup>3</sup> brackets are made to fix Wibe cable trays without tool.

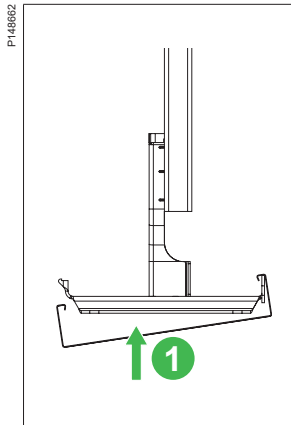

1 Insert one flange of the tray on the flat lip of the bracket.

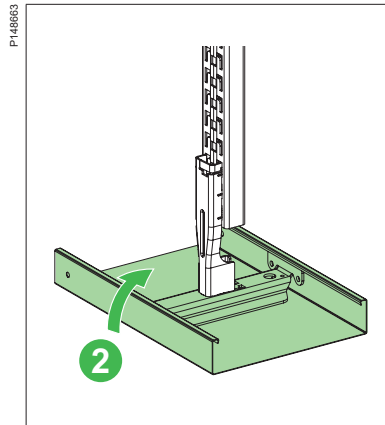

Pull up the other side and 2 snap the tray on the other lip.

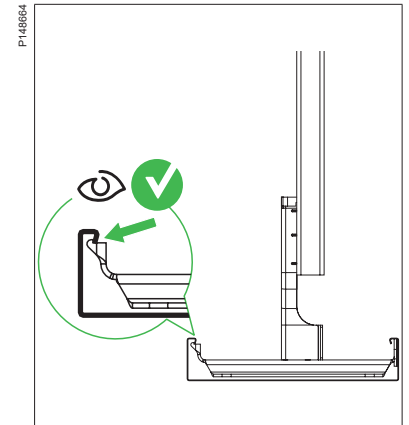

For safety, check if the tray is secured inside the bracket lips.



Apply caution with unintended upward movements as it can cause the tray to unlock and therefore be released from the bracket

#### Uninstallation of Wibe H40 cable tray from central suspension bracket

Wibe cable trays can be remove from the bracket.

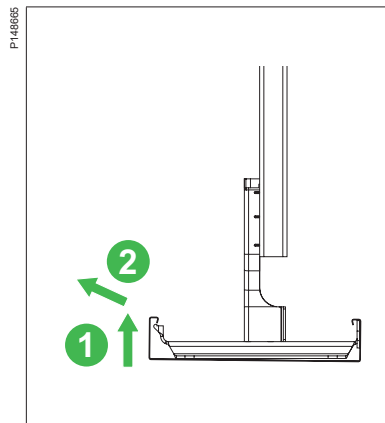

1 Push the cable tray up on the claw side.  
2 Pull the cable tray lip out of the bracket.

### Dividing strip 39

Dividing strip to be used to separate low-tension and high-tension cables.

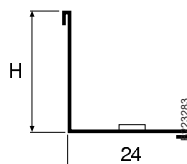
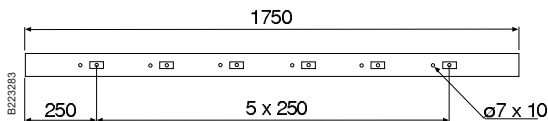
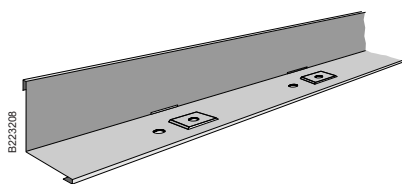

Type	H mm
Dividing strip 39/24	24
Dividing strip 39/55	55

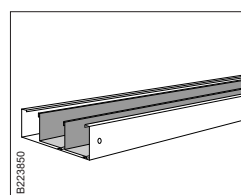

Used to separate tray or trunking in two or more ducts thereby separating control cables from other cables and pipes. The hole structure at distances of 250 mm permits two fixing opportunities with Support bands W6 even after cutting.

### Insert piece W39/55

Insert piece to be used to join Dividing strips 39/55 in Cable trays W1/60 or W3/60. The insert piece can be positioned on Support bracket/joint W7/60 to ensure a continuous separation of cables inside the cable tray.

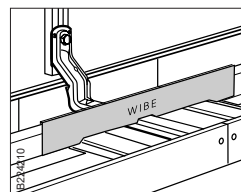
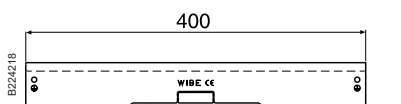
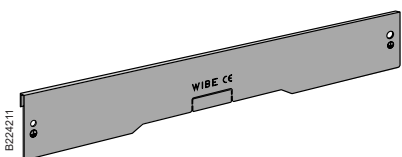

Insert piece W39/55 is used to join Dividing strips 39/55 and is mounted on Support bracket/joint W7/60.

### Insert piece W39

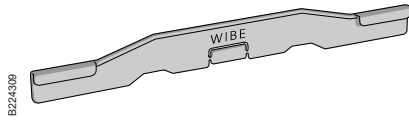

Insert piece to be used to join Dividing strips 39/24 in cable tray W1/W3 and lighting trunking W70/71. The Insert piece can be positioned on Support bracket/joint W7/40 to ensure a continuous separation of cables inside the cable tray.

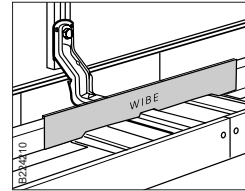
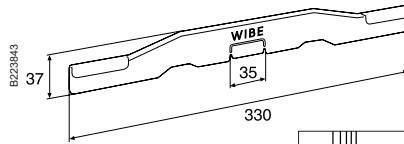

Insert piece W39 is used to join Dividing strips W39 and is mounted on Support bracket/joint W7 or Internal cantilever arm W17/40. When mounting over Internal cantilever arm W17/40, break away plastic bit from component.

### Support band W6

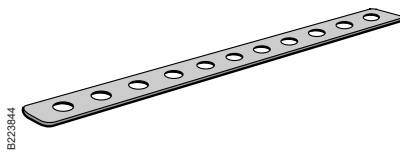

Support band to be placed inside cable trays to fix the lateral position of one or several Dividing strips W39. The holes in the support band and the locking pins in Dividing strip W39 enable an adjustment of the lateral positioning of the dividing strip with an interval of 25 mm.

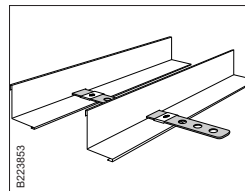
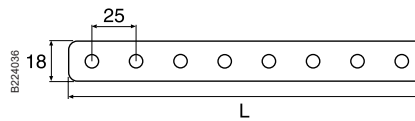

Support band W6 is mounted to fix one or more Dividing strips 39 laterally. The holes in the support band and the locking pins in Dividing strip 39 allow for a fixed division with intervals of 25 mm.

Type	L mm
Support band W6-70	67
Support band W6-100	97
Support band W6-200	197
Support band W6-300	297
Support band W6-400	397
Support band W6-500	497
Support band W6-600	597



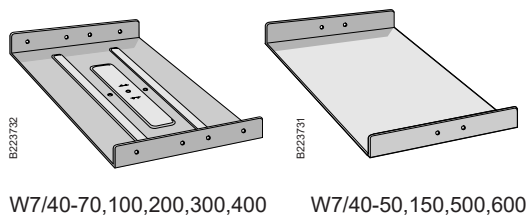

### Support bracket/joint W7/40

To be used as a support bracket or joint for cable tray W1/40, W3/40 and for lighting trunking W70. When joining cable tray W1/40 FS (reinforced), side joint W49/40 must be used.

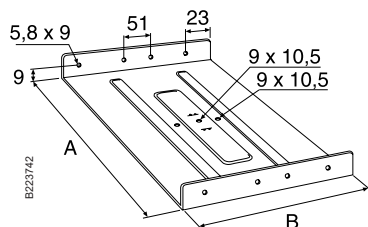

Type	A mm	B mm
Support bracket/joint W7/40-50	48	200
Support bracket/joint W7/40-70	68	200
Support bracket/joint W7/40-100	98	200
Support bracket/joint W7/40-150	148	200
Support bracket/joint W7/40-200	198	200
Support bracket/joint W7/40-300	297	300
Support bracket/joint W7/40-400	397	300
Support bracket/joint W7/40-500	498	300
Support bracket/joint W7/40-600	598	300

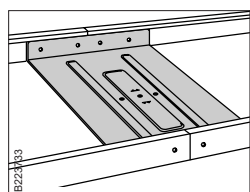

Support bracket/joint W7/40 is used for straight joining. Push-in mounting. See also Joint W7/40 HDG, p.99, used for joining of Hot dip galvanized trays.

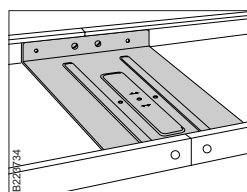

If necessary trays and lighting trunkings are locked using Screw set W38P or Locking plug W41.

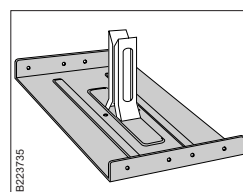

With Pendant attachment W21 installed on Support bracket/joint W7/40-100, 200, 300 or 400 a complete support bracket is obtained.

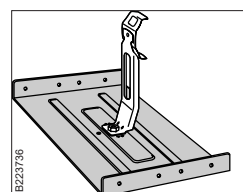

Tube pendant attachment W73 or the one half of Pendant attachment W21 are mounted on Support bracket/joint W7/40-70, 100, 200, 300 or 400 with Screw set W36/W36C.

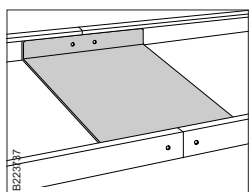

W7/40-50, 150, 500 and 600 are only used for joining, not as support brackets. Reinforced tray is to be joined with Side joint W49/40.

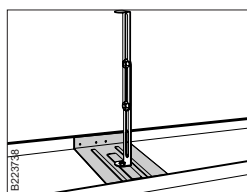

End bracket WN17 can be used as vertical piece on Support bracket/joint W7/40, mounted with Screw set W36/W36C.

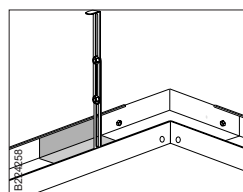

Support bracket/joint W7/40 is used to achieve an invisible suspension in or in connection with bends or junctions, here with End bracket WN17 mounted as vertical piece.

### Joint W7/40 HDG

Used as a joint for Hot dip galvanized Cable trays W3/40 and Lighting trunkings W70.

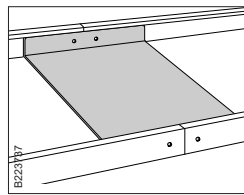
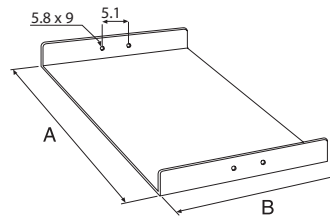
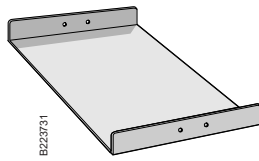

Joint W7/40 Hdg is only used for joining, not as support bracket. If necessary trays are locked using Screw set W38P or Locking plug W41

### Support bracket/joint W7/60

To be used as a support bracket or joint for cable tray W1/60, W3/60. When joining cable tray W1/60 FS (reinforced), side joint W49/60 must be used.

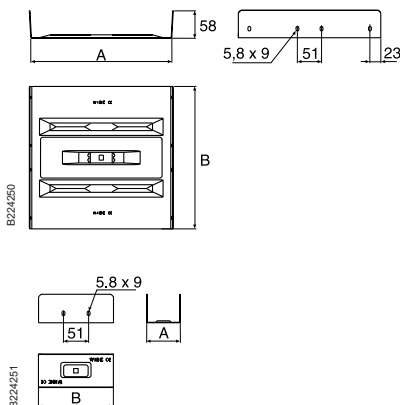
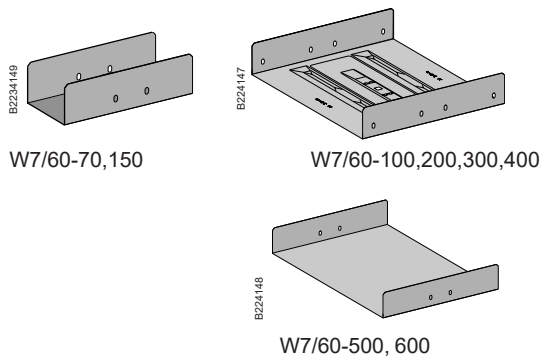

Type	A mm	B mm
Support bracket/joint W7/60-70	68	152
Support bracket/joint W7/60-100	98	200
Support bracket/joint W7/60-150	148	200
Support bracket/joint W7/60-200	198	200
Support bracket/joint W7/60-300	297	300
Support bracket/joint W7/60-400	397	300
Joint W7/60-500	498	300
Joint W7/60-600	598	300

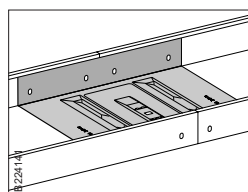

Support bracket/joint W7/60 is used for straight joining. Push-in mounting.

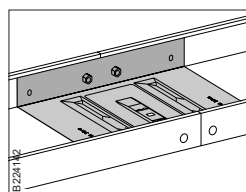

If necessary trays are locked using Screw set W38P or Locking plug W41.

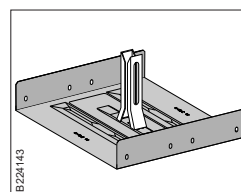

With Pendant attachment W21 installed, a complete support bracket is obtained. Does not apply to W7/60-70, 150, 500 and 600.

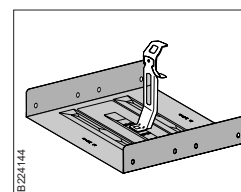

Tube pendant attachment W73 or one half of Pendant attachment W21 are mounted with Screw set W36/W36C. Does not apply to W7/60-500 and 600.

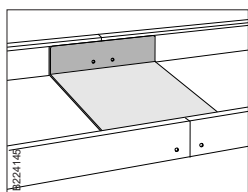

W7/60-500 och 600 are only used for joining, not as support brackets. Reinforced tray is to be joined with Side joint W49/60.

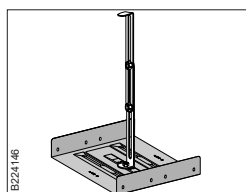

End bracket WN17 can be used as vertical piece on Support bracket/joint W7/60 mounted with Screw set W36/W36C.

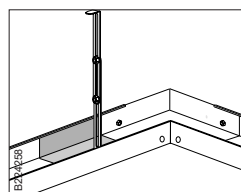

Support bracket/joint W7/60 is used to achieve an invisible suspension in or in connection with bends or junctions, here with End bracket WN17 mounted as vertical piece.

### Support bracket W20

Support bracket to be used for invisible installation of lighting trunking W70/71, width 70 and 100 mm. The support bracket is snapped firmly into the trunking. Two nuts M10 are included. Suitable for threaded rod W76 M10.

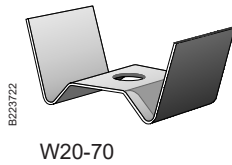

W20-70

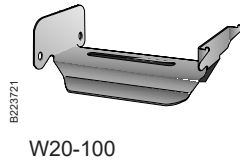

W20-100

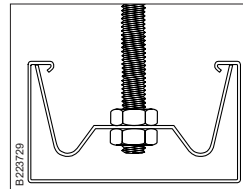
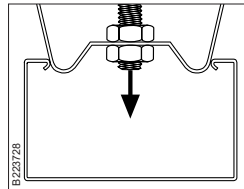

Lightly press down Support bracket W20-70 into Lighting trunking W70-70.

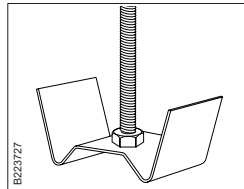

Mount Support bracket W20-70 onto Threaded rod W76 M10 with 2 M10 nuts.

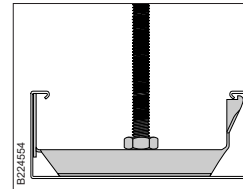

Support bracket W20-100 is mounted onto Threaded rod W76 M10 with 2 M10 nuts.

### Support bracket W20A

Support bracket to be used for invisible installation of lighting trunking W70/71, width 70 and 100 mm. The support bracket is snapped firmly into the trunking. The spring locking device facilitates easy vertical height adjustment. Suitable for threaded rod W76 M10.

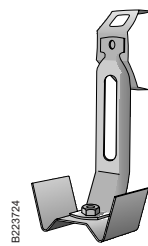

W20A-70

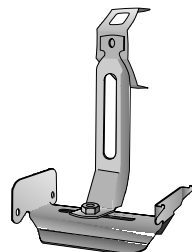

W20A-100

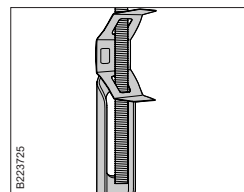

Support brackets W20A-70 and W20A-100 are mounted on Threaded rod W76 M10. This enables simple vertical adjustment of  $\pm 30$  mm.

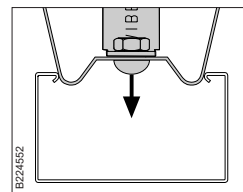

Lightly press down Support bracket W20A-70 into Lighting trunking W70-70.

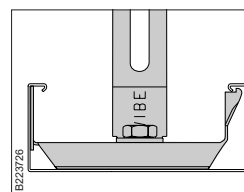

Support bracket W20A-100 is easily snapped firmly into Lighting trunking W70-100.

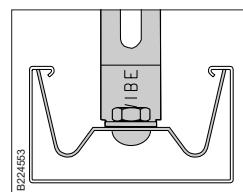

### Pendant bracket W80/W81

Pendant bracket to be used to support lighting trunking W70-50. W80 pendant bracket facilitates easy vertical height adjustment on threaded rod. W81 needs to be suspended with Pendant rail W32.

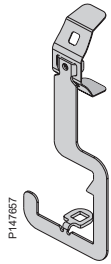

W80

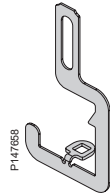

W81

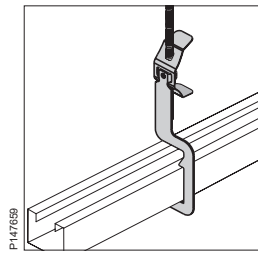
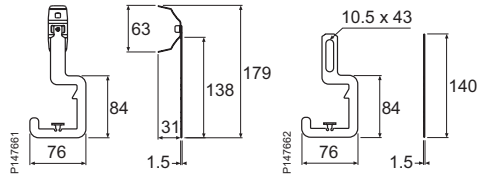

Pendant bracket W80 is mounted under Lighting trunking W70-50 and attached with Screw set W36/W36C. Threaded rod W76 M6 is easily mounted in the spring clasp without bolts. Adjustable to  $\pm 30$  mm.

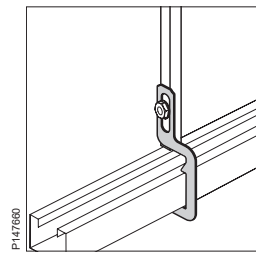

Pendant bracket W81 is mounted under Lighting trunking W70-50 and is attached with Screw set W36/W36C. Pendant rail W32 is mounted using Screw set W37. Adjustable to  $\pm 18$  mm.

### Support bracket W1940

Support bracket to be used for invisible installation of cable trays W1/40 and W3/40.

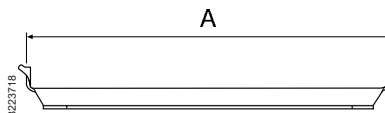
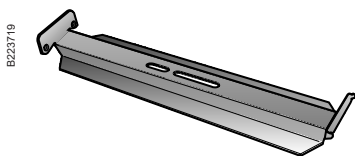

Type	A mm
Support bracket W1940-100	90
Support bracket W1940-200	190
Support bracket W1940-300	289
Support bracket W1940-400	389
Support bracket W1940-500	489
Support bracket W1940-600	589

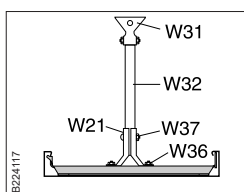

Tray W1/40 and W3/40, widths 200 to 400, are mounted with suitable Support bracket W1940, Pendant rail W32, Pendant attachment W21, Screw sets W37 and W36/W36C. Trays with width 100 can be mounted with Support bracket W1940-100, one half of Pendant attachment W21 or Tube pendant attachment W73 and Screw set W36/W36C.

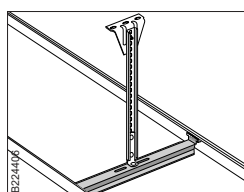

Support bracket W1940 mounted with Ceiling bracket 5, Pendant/Fixing rail 24/34 and Angle bracket W8S. Screw set 22S must be used. For cable tray widths 500 and 600.

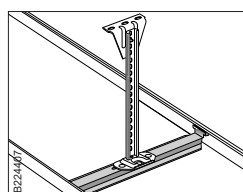

Support bracket W1940 mounted on Vertical piece 2 and Ceiling bracket 5. Screw set 22S must be used. For cable tray widths 500 och 600.

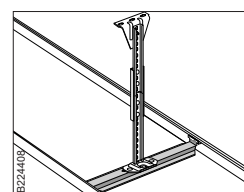

Support bracket W1940 can be mounted with Vertical piece 2, Pendant joint 2J, Pendant/Fixing rail 24/34 and Ceiling bracket 5. Screw set 22S must be used. For cable tray widths 500 and 600.

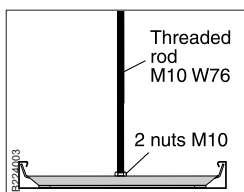

Alternatively, Tray W1/40 and W3/40 with widths 500 and 600 can be installed with suitable Support bracket W1940, Threaded rod W76 M10 and 2 M10 nuts.

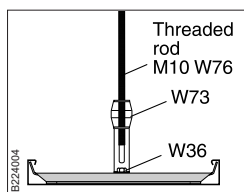

Alternatively, Tray W1/40 and W3/40 with widths 500 and 600 can be installed with suitable Support bracket W1940, Threaded rod W76 M10 and Tube pendant attachment W73.

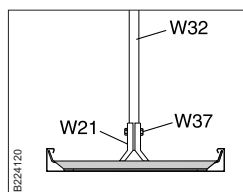

Alternatively, Tray W1/40 and W3/40 with widths 500 and 600 can be installed with suitable Support bracket W1940, Pendant rail W32, Pendant attachment W21 and Screw set W37.

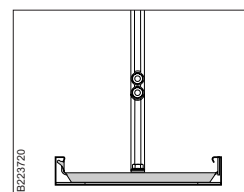

Tray W1/40 and W3/40 can be mounted on suitable Support bracket W1940 and 2 End bracket WN17 as pendant. The end brackets are joined with 2 Screw sets 22S and can be adjusted in height. The pendant can be mounted in the support bracket with Screw set W36/W36C.

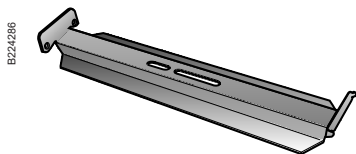

### Support bracket W1960

Support bracket to be used for invisible installation of cable trays W1/60 and W3/60.

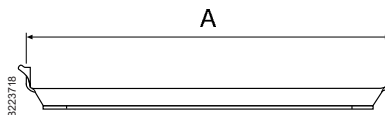

Type	A mm
Support bracket W1960-100	89
Support bracket W1960-200	189
Support bracket W1960-300	289
Support bracket W1960-400	389
Support bracket W1960-500	489
Support bracket W1960-600	589

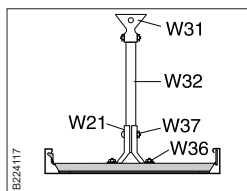

Tray W1/60 and W3/60, widths 200 to 400, are mounted with suitable Support bracket W1960 and Pendant rail W32, Pendant attachment W21 and Screw set W37. Trays with width 100 can be mounted with Support bracket W1960-100, one half of Pendant attachment W21 or Tube pendant attachment W73 and Screw set W36/W36C.

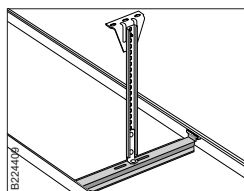

Support bracket W1960 mounted with Ceiling bracket 5, Pendant/Fixing rail 24/34 and Angle bracket W8S. Screw set 22S must be used. For cable tray widths 500 and 600.

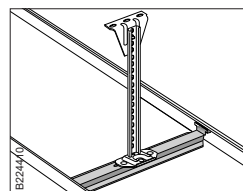

Support bracket W1960 mounted on Vertical piece 2 and Ceiling bracket 5. Screw set 22S must be used. For cable tray widths 500 och 600.

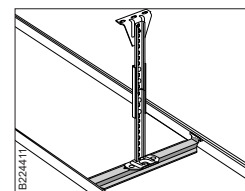

Support bracket W1960 can be mounted with Vertical piece 2, Pendant joint 2J, Pendant/Fixing rail 24/34 and Ceiling bracket 5. Screw set 22S must be used. For cable tray widths 500 and 600.

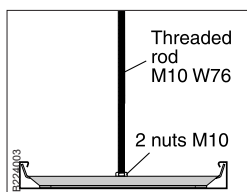

Alternatively, Tray W1/60 and W3/60, widths 500 and 600, can be installed with suitable Support bracket W1960, Threaded rod W76 M10 and 2 M10 nuts.

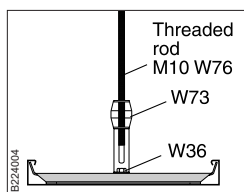

Alternatively, Tray W1/60 and W3/60, widths 500 and 600, can be installed with suitable Support bracket W1960, Threaded rod W76 M10 and Tube pendant attachment W73.

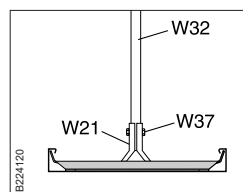

Alternatively, Tray W1/60 and W3/60, widths 500 and 600, can be installed with suitable Support bracket W1960, Pendant rail W32, Pendant attachment W21 and Screw set W37.

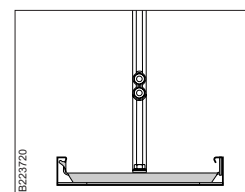

Tray W1/60 and W3/60 can be mounted on suitable Support bracket W1960 with 2 End brackets WN17 used as pendant. The end brackets are joined with 2 Screw sets 22S and can be adjusted in height. The pendant can be mounted in the support bracket with 1 Screw set W36.



### Internal cantilever arm W17

Internal cantilever arm to be used for invisible mounting inside cable tray W1/40 and W3/40.

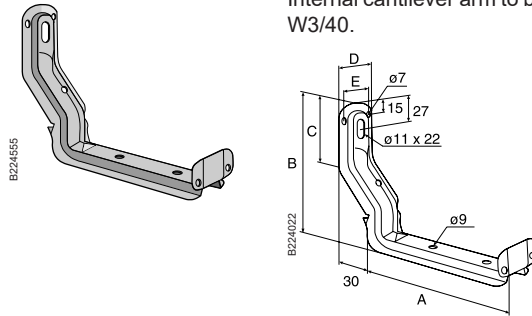

Type	A mm	B mm	C mm	D mm	E mm
W17/40-100	89	140	70	55	42
W17/40-200	189	140	70	55	42
W17/40-300	289	165	95	75	55
W17/40-400	389	165	95	75	55

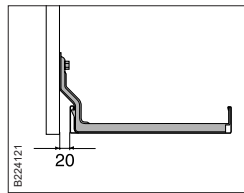

Internal cantilever arm W17/40 is mounted on Vertical piece 2F using a T-bolt.

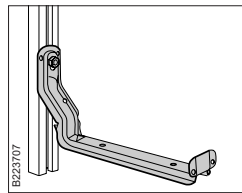

When mounting an Internal cantilever arm W17/40 on a porous wall or when surface pressure must be reduced use Mounting rail 40.

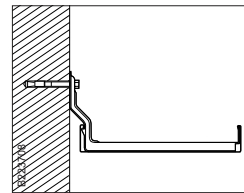

The Internal cantilever arm is mounted onto the wall with an Expansion bolt alt. a Concrete screw.

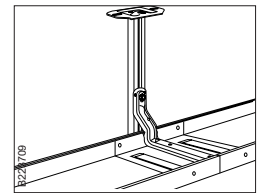

Internal cantilever arm W17/40 can be mounted right over support bracket/joint.

### Loading table for Internal cantilever arm W17/40 on wall

Cantilever arm type	Max load F at 3° deflection of cantilever arm		Deflection in mm vid 3° deflection of cantilever arm	Breaking load	
	kN	kg		kN	kg
W17/40-100	1.0	100	5.2	3.0	300
W17/40-200	0.8	80	10.5	2.0	200
W17/40-300	1.1	110	15.7	3.0	300
W17/40-400	1.0	100	20.9	2.0	200

Mounted onto wall with Expansion bolt. Breaking load for cantilever arm mounted onto wall, see below.

### Adjustable cantilever arm W1840

Adjustable cantilever arm to be used for invisible mounting inside cable trays W1/40 and W3/40. Adjustability 0-25 mm W1840-100 and 0-50 mm W1840-200 to 600.

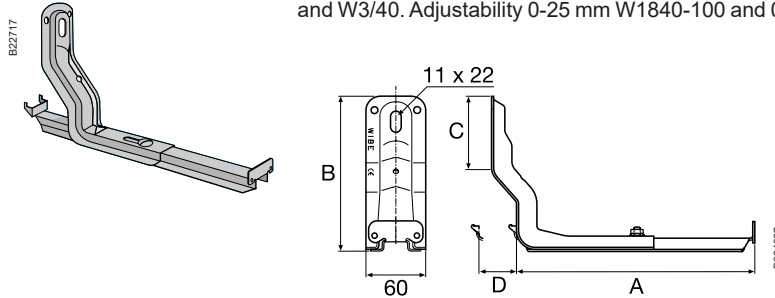

Type	A mm	B mm	C mm	D mm
W1840-100	88	160	70	0-25
W1840-200	188	160	70	0-50
W1840-300	289	185	95	0-50
W1840-400	389	185	95	0-50
W1840-500	489	185	95	0-50
W1840-600	589	185	95	0-50

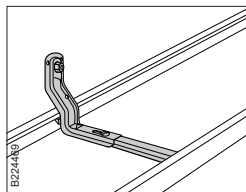

Mounting directly onto wall. At this type of installation the adjusting allowance of the tray is limited. Breaking load - see table above.

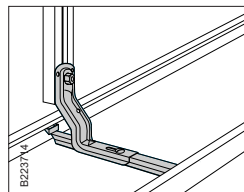

Mounting on Vertical piece 2F using T-bolt. The Cantilever arm W1840 can be adjusted to a max. of 50 mm.

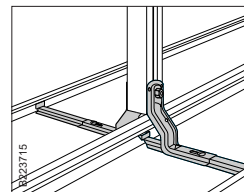

Mounting of two adjustable cantilever arms on the same Vertical piece 2F. (Tray widths more than 400 mm). Use Screw set 20S if the two trays have the same width. At different tray widths T-bolt 26U and Screw set W37 must be used.

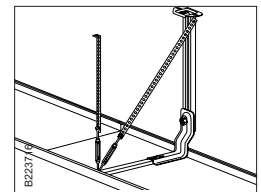

When mounting cable trays, widths 500-600 mm, it might be necessary with a reinforcement of the cantilever arm. Installation band and stretching screw can be used for mounting in ceiling or on a vertical piece.

### Loading table for cantilever arm W1840 on wall

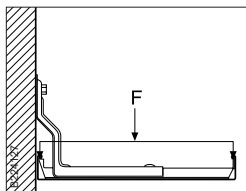

Mounted onto wall with Expansion bolt. Breaking load for cantilever arm mounted onto wall.

type	Max load F at 3° deflection of cantilever arm		Deflection at 3° deflection of cantilever arm mm	Breaking load	
	kN	kg		kN	kg
W1840-100	1.0	100	5.2	3.0	300
W1840-200	0.8	80	10.5	2.0	200
W1840-300	1.1	110	15.7	3.0	300
W1840-400	1.0	100	20.9	2.0	200
W1840-500	0.65	65	26	1.3	130
W1840-600	0.5	50	31.5	1.0	100

### Adjustable cantilever arm W1860

Adjustable cantilever arm to be used for invisible mounting inside cable trays W1/60 and W3/60. Adjustability 0-25 mm W1860-100 and 0-50 mm W1860-200 to 60.

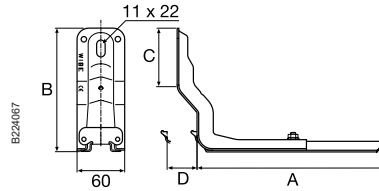
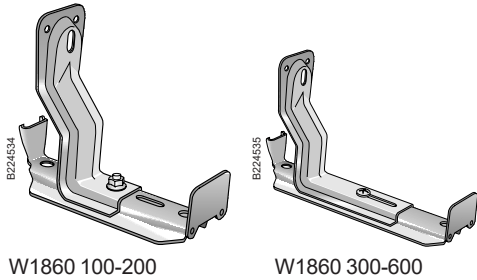

Type	A mm	B mm	C mm	D mm
W1860-100	89	160	70	0-25
W1860-200	189	160	70	0-50
W1860-300	289	185	95	0-50
W1860-400	389	185	95	0-50
W1860-500	489	185	95	0-50
W1860-600	589	185	95	0-50

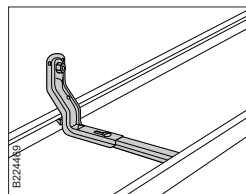

Mounting directly onto wall. At this type of installation the adjusting allowance of the tray is limited. Breaking load - see table below.

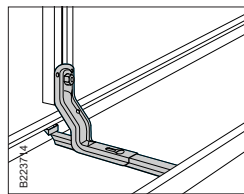

Mounting on Vertical piece 2F using T-bolt. The Cantilever arm W1860 can be adjusted to a max. of 50 mm.

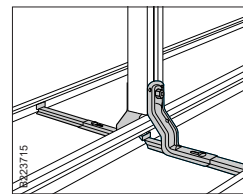

Mounting of two adjustable cantilever arms on the same Vertical piece 2F. (For trays wider than 400 mm). Use Screw set 20S if the two trays have the same width. At different tray widths T-bolt 26U and Screw set W37 must be used.

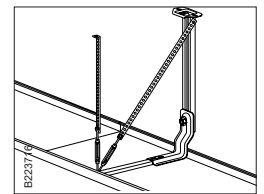

When mounting cable trays, widths 500-600 mm, it might be necessary with a reinforcement of the cantilever arm. Installation band and stretching screw can be used for mounting in ceiling or on a vertical piece.

### Loading table for cantilever arm on wall

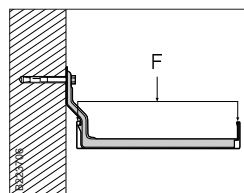

Mounted onto wall with Expansion bolt. Breaking load for cantilever arm mounted onto wall.

Cantilever arm type	Max load F at 3° deflection of cantilever arm		Deflection in mm at 3° deflection of cantilever arm	Breaking load	
	kN	kg		kN	kg
W1860-100	1.0	100	5.2	3.0	300
W1860-200	0.8	80	10.5	2.0	200
W1860-300	1.1	110	15.7	3.0	300
W1860-400	1.0	100	20.9	2.0	200
W1860-500	0.65	65	26.0	1.3	130
W1860-600	0.5	50	31.5	1.0	100

### Back plate W30

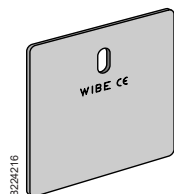

Back plate to be used for wall installation of internal cantilever arms on porous walls, to reduce the surface pressure.

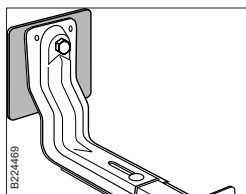
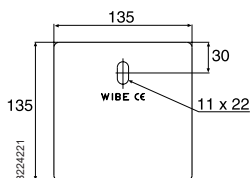

Mount Back plate W30 as shown in the illustration to reduce the surface stress on porous walls.

### Mounting rail 40

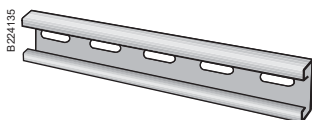

Mounting rail to be used for wall installation of cantilever arms on porous walls to reduce the surface pressure or to enable height adjustment of cantilever arms.

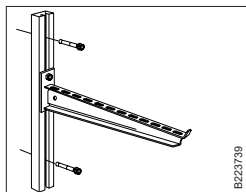
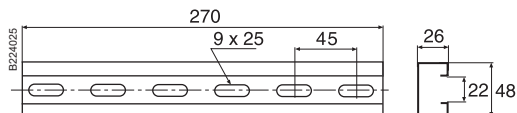

The mounting rail is installed between a cantilever arm and wall to reduce surface pressure on porous walls or to enable vertical adjustment of cantilever arms.

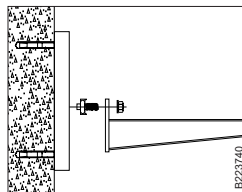

Cantilever arm 50 is installed using a T-bolt. The cantilever arm is vertically adjustable.

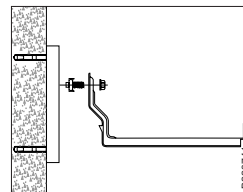

Internal cantilever arm W17 and Adjustable cantilever arm W1840 are mounted with T-bolt. The cantilever arm is vertically adjustable.

### Vertical piece 2Fi

Vertical piece to be used for lighter mountings with Cantilever arm 50i.

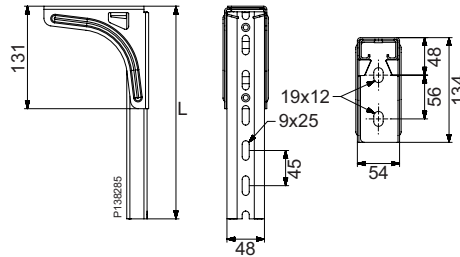

Type	L mm
Vertical piece 2Fi-300	272
Vertical piece 2Fi-500	497
Vertical piece 2Fi-750	722
Vertical piece 2Fi-1000	992

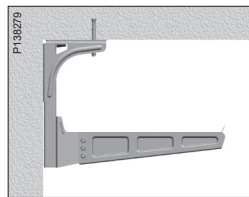

Vertical piece 2Fi can be mounted in ceiling close to wall.

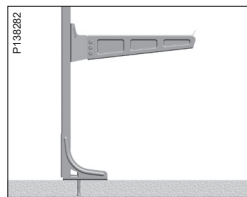

Vertical piece 2Fi is suitable for floor mounting.

#### Loadings

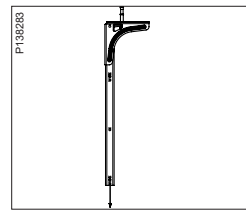

Vertical piece 2Fi mounted in the inner hole. Breaking load=500 kg (5 kN) at symmetrical loading.

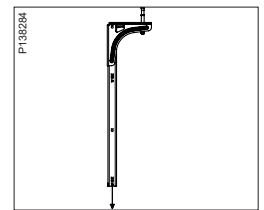

Vertical piece 2Fi mounted in the outer hole. Breaking load=100 kg (1 kN) at symmetrical loading.

### Vertical piece 2F

Vertical piece to be used for installation of Internal cantilever arm W17/40, Adjustable cantilever arm W18/40 or Cantilever arm 50/50L. Can be joined to Pendant/fixing rail 24/48 with Pendant joint 2FJ.

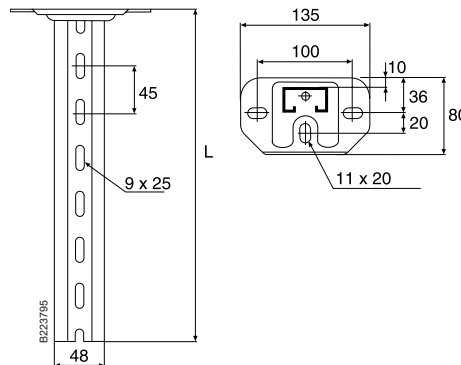
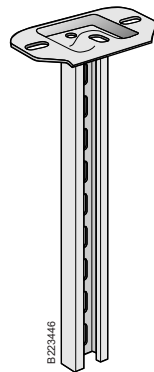

Type	L mm
Vertical piece 2F/280	280
Vertical piece 2F/370	370
Vertical piece 2F/505	505
Vertical piece 2F/640	640
Vertical piece 2F/730	730
Vertical piece 2F/865	865
Vertical piece 2F/1000	1000
Vertical piece 2F/1500	1495

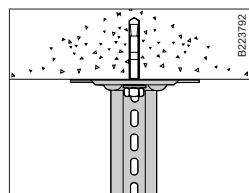

Mounted in ceiling with Expansion bolt alt. Concrete screw.

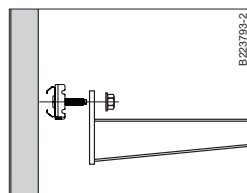

Cantilever arm 50 is mounted with a T-bolt 26U.

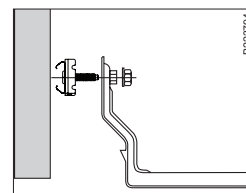

Internal cantilever arm W17/40 is mounted with a T-bolt 26U.

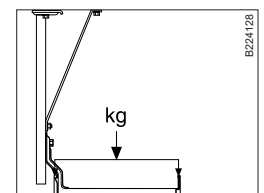

In order to reduce the deflection of Vertical piece 2F for heavy loads on Internal cantilever arm W17/40 and Adjustable cantilever arm W1840/ W1860, Pendant bar 1 is installed.

### Ceiling bracket 5TPA

Ceiling bracket with telescopic function, to be used for mounting of various sizes of trapezoid plates. Including screw MVBF 8x16 and nut M6MF8. Breaking load: 150 kg without deformation.

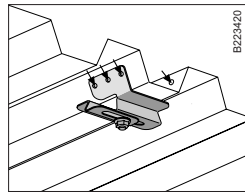
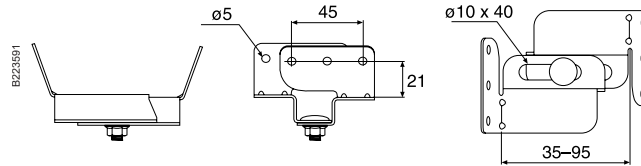
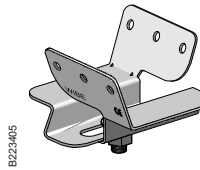

Ceiling bracket 5TPA can be mounted in trapezoid plate with blind rivets or suitable screws. The bracket is adjustable from 35 to 95 mm.

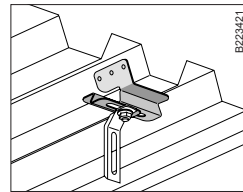

Pendant attachment W21 or Tube pendant attachment W73 (Wibe Cable Tray) can be mounted in Ceiling bracket 5TPA with the existing screw.

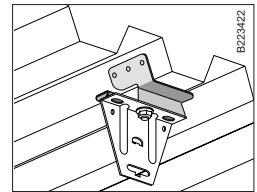

Ceiling bracket 5 or Ceiling attachment W31 can be mounted with the existing screw.

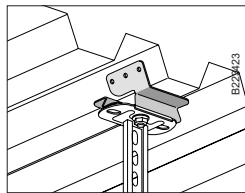

Vertical piece 2 or 2F can be mounted with the existing screw.

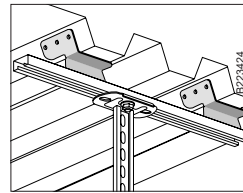

Install Mounting rail 40 between 2 Ceiling brackets 5TPA if the vertical piece must be adjusted sideways.

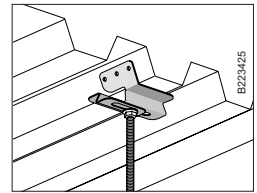

Pendant W76 M8 or M10 installed in Ceiling bracket 5TPA.

### Breaking load

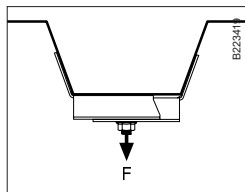

Ceiling bracket 5TPA can be loaded with  $F=150$  kg without deformation. For loading figures for thin plate or fixing elements, follow suppliers recommendations.

### Ceiling attachment W31

Ceiling attachment to be used for installations with Pendant rail W32.

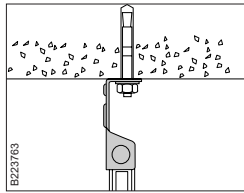
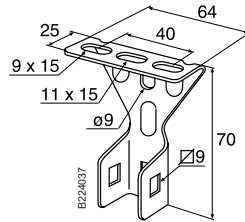
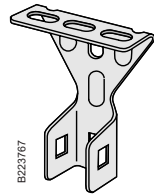

The Ceiling attachment W31 is mounted in concrete ceilings with one or two Expansion bolts. Pendant rail W32 is mounted with Screw set W37. Can be rotated 90°.

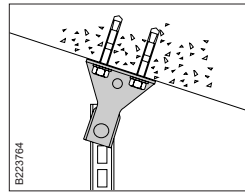

The Ceiling attachment W31 can be mounted directly in a slanted ceiling with Expansion bolts.

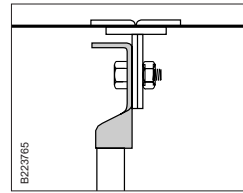

The Ceiling attachment W31 can be mounted directly in TP ceilings using an Ogebe fixing type E.

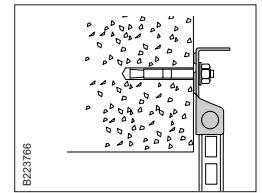

The Ceiling attachment W31 can be mounted onto a concrete beam with Expansion bolts.

### Pendant rail W32

Pendant rail W32 can be installed in ceilings together with Ceiling attachment W31 or Ogebe fixing type E.

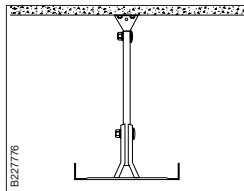
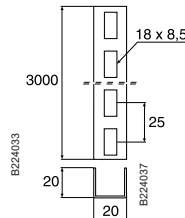

The Pendant rail W32 is cut to the required length and mounted in the ceiling with Ceiling attachment W31 and Pendant attachment W21 mounted onto Support bracket/joint W7.

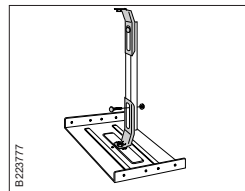

For lighter installations with small loads, one half of Pendant attachment W21 is mounted in Support bracket W7 with Screw set W36/ W36C. The second part is used as a ceiling bracket, Pendant rail W32 is mounted using Screw set W37.

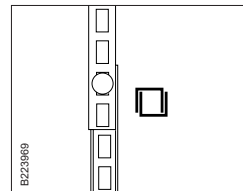

2 Pendant rails W32 can be joined by placing them over-lapping each other, see above. Use Screw set W37 for assembling.

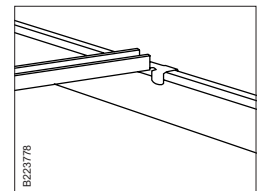

Using Locking clamp W77, the Pendant rail W32 can be mounted between two lighting trunkings or cable trays, either as a stabiliser or to form a simple duct.



### Pendant attachment W21

Pendant attachment to be used in combination with pendant rail W32, support bracket/joint W7, etc.

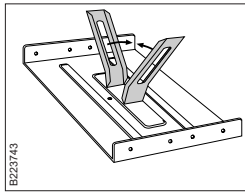
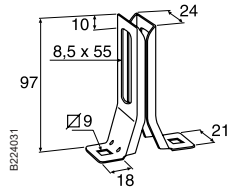
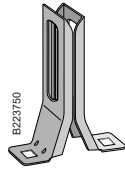

The Pendant attachment W21 is inserted into the slits in the Support bracket/joint W7 (100-400). Does not apply to W7-50, 150, 500 and 600.

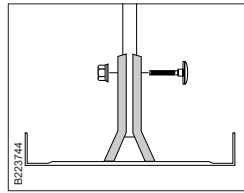

The required length of Pendant rail W32 is mounted in the Pendant attachment W21 with Screw set W37. Adjustable to  $\pm 30$  mm.

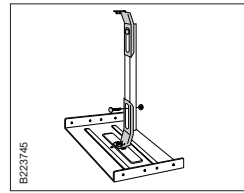

For lighter installations with small loads, only one half of the Pendant attachment W21 is mounted in Support bracket W7 with Screw set W36/W36C. The second part of the Pendant attachment W21 is used as a ceiling bracket. The Pendant rail W32 is mounted using Screw set W37.

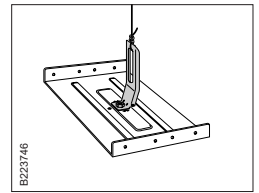

When mounting with wire, only one half of the Pendant attachment W21 is mounted in Support bracket/joint W7 using Screw set W36/W36C. The wire is mounted through the oval hole and locked with a wire lock.

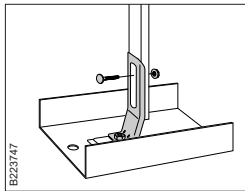

When mounting tray or Lighting trunking W70, one half of the Pendant attachment W21 is mounted directly in Support bracket/joint W7 with Screw set W36/W36C. The pendant rail is mounted with Screw set W37.

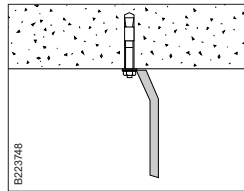

In concrete ceilings Pendant attachment W21 is mounted with Expansion bolt.

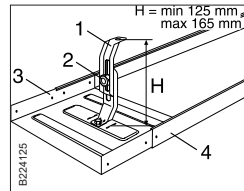

1. Pendant attachment W21
2. Screw set W36/W36C
3. Support bracket/joint W7
4. Cable tray/Lighting trunking

### Ceiling installation with cable tray/lighting trunking

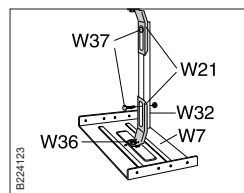
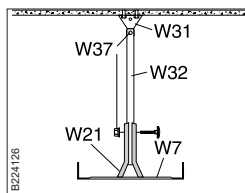

- W7 = Support bracket/joint
- W21 = Pendant attachment
- W31 = Ceiling attachment
- W32 = Pendant rail
- W36 = Screw set
- W37 = Screw set

### Pendant attachment W73

Tube pendant attachment to be used for mounting of threaded rod W76 M6, M8 or M10 in ceiling and cable tray. Provides a quick and screw-less height adjustment of the threaded rod.

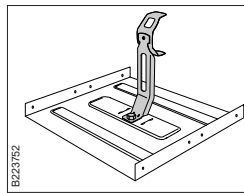
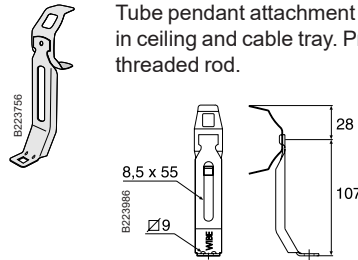

The Tube pendant attachment W73 is mounted in Support bracket/joint W7 with Screw set W36/W36C. Does not apply to W7-500 and 600.

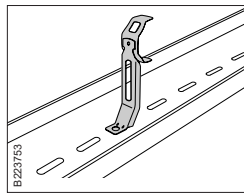

The Tube pendant attachment can be mounted directly in the lighting trunking using Screw set W36/W36C. Does not apply to Lighting trunking W70-40.

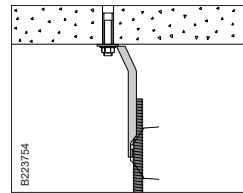

Threaded rod M6, M8 or M10 is easily mounted in the spring clasp without screws. Simple adjustment up to  $\pm 30$  mm. Mounted in concrete ceilings with Expansion bolt.

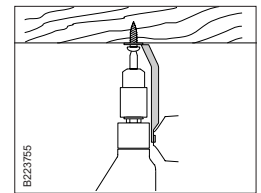

Mounted in wood with self-drilling screws.

### Threaded rod B41 and W76 M6, M8, M10

Used for installation of cable trays and lighting trunkings.

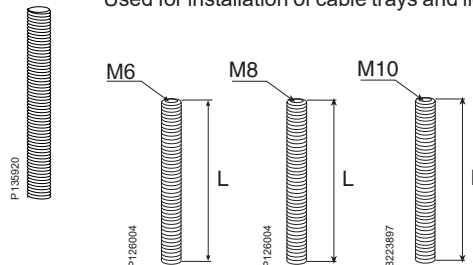

Type and Surface treatment	L= 1000mm	L= 2000mm	L= 3000mm
M6 EZ	W76	W76	W76
M8 EZ	W76	-	-
M10 EZ	-	W76	W76
M8 HDG	W76	W76	-
M8 AISI 316L	B41	B41	-
M10 AISI 316L	B41	B41	-

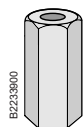

### Joint nut M6, M8, M10

Used for joining of Threaded rods.

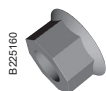

### Flange nut M6, M8, M10

Flange nut is mounted onto Threaded rods in order to lock support brackets and ceiling brackets.



### Thread lock M6, M8, M10

Used for joining of Threaded rod.

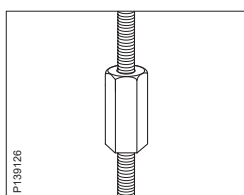

Joint nut is used for joining of Threaded rods.

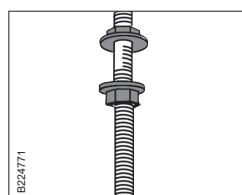

Flange nuts are mounted onto the Threaded rod in order to lock support brackets and ceiling brackets.

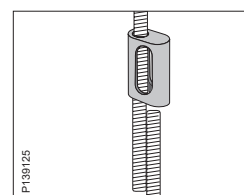

Thread lock is used for joining of Threaded rods. Max. permitted load=80kg

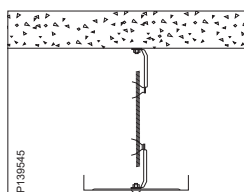

The Threaded rod is cut to required length and mounted with 2 Tube pendant attachments W73.

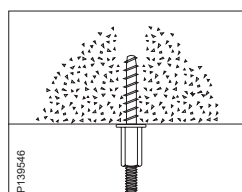

Installation of Threaded rod with Concrete screw MMS-I.

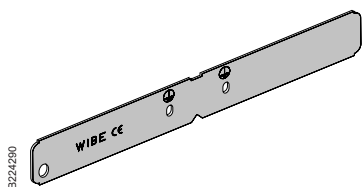

### Side joint W49/40

Side joint to be used for straight joining of cable tray W1/40 and W3/40.

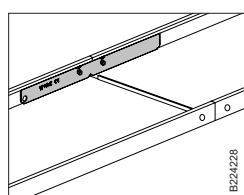
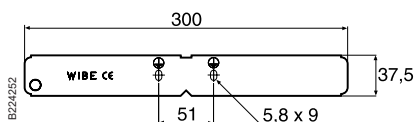

2 Side joints W49/40 are used for straight joining of Cable tray W1/40, W1/40 FS and W3/40. 4 Screw sets W38P are required (not included). For trays 300 mm and wider we recommend to use Support bracket/joint W7/40.

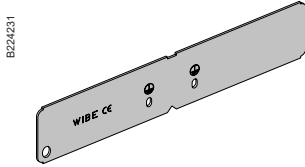

### Side joint W49/60

Side joint to be used for straight joining of cable tray W1/60 and W3/60.

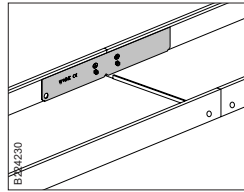
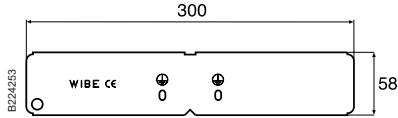

2 Side joints W49/60 are used for straight joining of Cable trays W1/60, W1/60 FS and W3/60. 4 Screw sets W38P are required (not included). For trays 300 mm and wider we recommend to use Support bracket/joint W7/60.

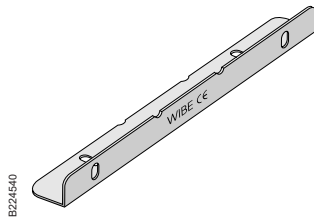

### Joint W2

Side joint to be used for straight joining of installation tray W4.

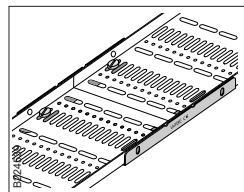
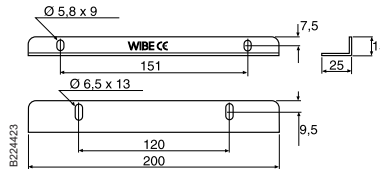

Used for joining Installation tray W4. To be mounted on the outside of the tray and attached in bottom with 2 Screw sets W34 (pre-galvanized, stainless steel and pre-galvanized powder coated trays). For hot dip galvanized and hot dip galvanized powder coated trays Screw set W38P must be used.

### T-joint W9/40

T-joint to be used to construct T-sections or X-sections. Also used for oblique branches. The ref. number includes two pieces of T-joints and Screw set W38P.

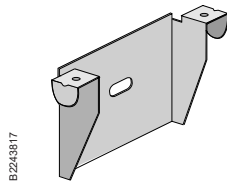

B2243817

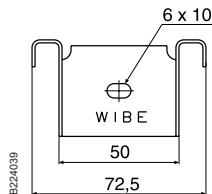

B224039

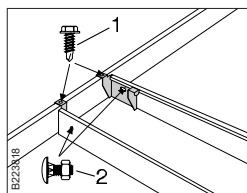

B223918

**Potential balancing**  
In order to fulfil the potential balancing according to SS-EN 61537 the T-joint must be secured with

- 1 Self-drilling screw RXB 4.2 x 13
- 2 Screw set W38P, drilling is required.

Tightening torque 2 Nm.

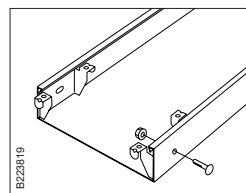

B223819

T-joint W9/40 is mounted on the side edges of the tray with Screw set W38P.

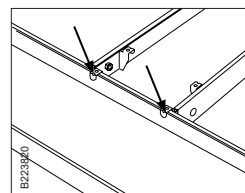

B223940

**Straight angling.** If necessary, the lugs are locked to the edge of the tray using pliers. Can also be locked with blind rivets or selftapping screws.

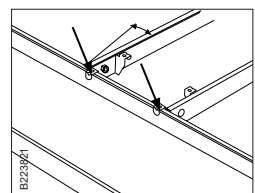

B223954

**Oblique angling.** If necessary, the lugs are locked to the edge of the tray using pliers. Can also be locked with blind rivets or selftapping screws.

### T-joint W9/60

T-joint to be used to construct T-sections or X-sections. Also used for oblique branches. The ref. number includes two pieces of T-joints and Screw set W38P.

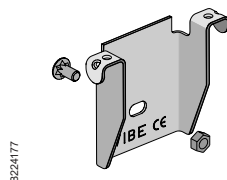

B224177

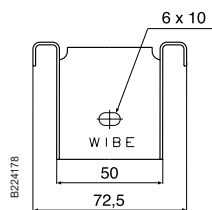

B224178

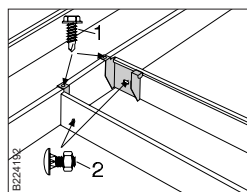

B224182

**Potential balancing**  
In order to fulfil the potential balancing according to SS-EN 61537 the T-joint must be secured with

- 1 Self-drilling screw RXB 4.2 x 13
- 2 Screw set W38P, drilling is required.

Tightening torque 2 Nm.

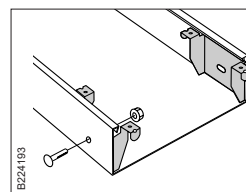

B224193

T-joint W9/60 is mounted on the side edges of the tray with Screw set W38P.

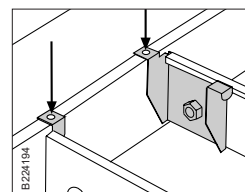

B224194

**Straight branches.** If necessary, the lugs are locked to the edge of the tray using pliers. Can also be locked with blind rivets or selftapping screws.

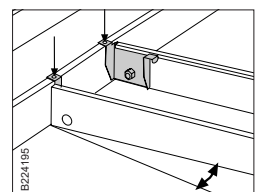

B224195

**Oblique branches.** If necessary, the lugs are locked to the edge of the tray using pliers. Can also be locked with blind rivets or selftapping screws.

### T-joint W29/40

T-joint to be used to construct T-junctions or X-junctions. Easy push-in assembly. Locks into the tray via locking flap. To be suspended over the lateral side of the tray and locked in a suitable way.

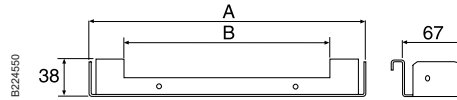
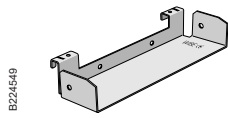

Type	A mm	B mm
T-joint W29/40-70	68	-
T-joint W29/40-100	98	-
T-joint W29/40-200	198	120
T-joint W29/40-300	301	220
T-joint W29/40-400	401	320
T-joint W29/40-500	501	420
T-joint W29/40-600	601	520

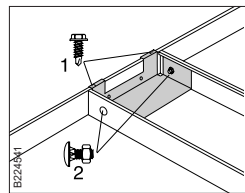

#### Potential balancing

In order to fulfil the potential balancing according to SS-EN 61537 the T-joint must be secured with

- 1 Self-drilling screw RXB 4 2 x 13
- 2 Screw set W38P

Tightening torque 2 Nm.

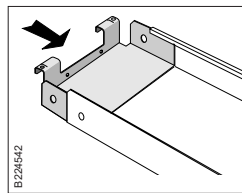

Simply installed with push-in mounting. Lock into tray with Screw set W38P.

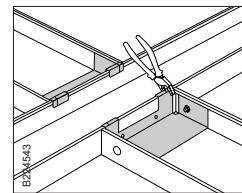

Used with T- and X-junction. Mounted directly onto tray edge. Can be attached to tray by pinching the lip at the top of the tray.

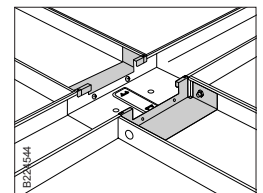

Used with open junction together with Joint W7/40 with opening and Tray W1/40 with opening. Attached with Screw set W38P.

Examples of suspensions with open junction where T-joint W29/40, Tray W1/40 with opening and Joint W7/40 with opening are included.

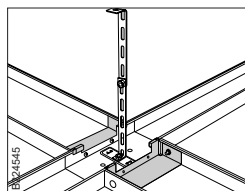

Suspension with Pendant strip W33.

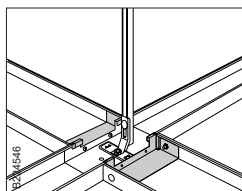

Suspension with Pendant rail W32 and half a Pendant attachment W21.

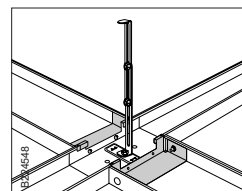

Suspension with End bracket WN17.

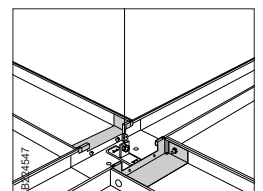

Suspension with wire and Ogebe fixing type E.

### T-joint W29/60

T-joint to be used to construct T-junctions or X-junctions. Easy push-in assembly. Locks into the tray via locking flap. To be suspended over the lateral side of the tray and locked in a suitable way.

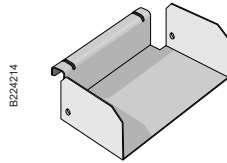

B224214

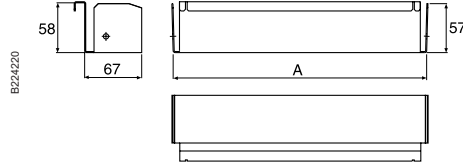

B224220

Type	A mm
T-joint W29/60-70	68
T-joint W29/60-100	98
T-joint W29/60-200	198
T-joint W29/60-300	298
T-joint W29/60-400	398
T-joint W29/60-500	498
T-joint W29/60-600	598

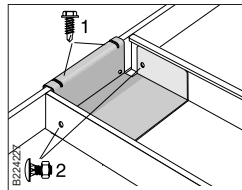

B22422X

#### Potential balancing

In order to fulfil the potential balancing according to SS-EN 61537 the T-joint must be secured with

- 1 Self-drilling screw RXB 4.2 x 13
- 2 Screw set W38P  
Tightening torque 2 Nm.

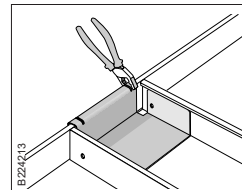

B224213

Used with T- and X-junction. Mounted directly onto tray edge. Can be attached to tray by pinching the lip at the top of the tray.



### Vertical riser W11/40, W11F/40

Vertical riser to be used as internal or external riser. Can be bent to the desired angle up to 90°. Push-in installation. The riser is delivered flat.

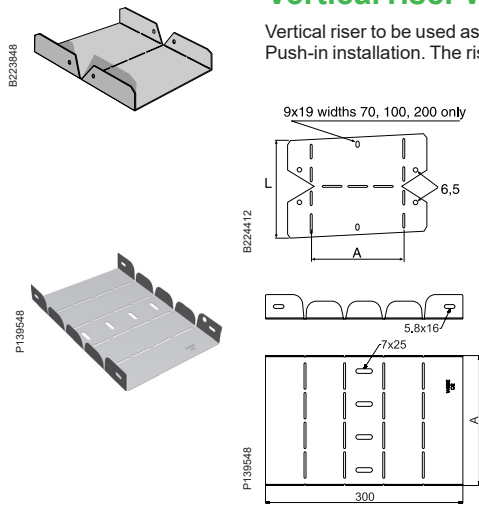

Type	A mm	L mm
Vertical riser W11/40-50	48	150
Vertical riser W11/40-70	68	150
Vertical riser W11/40-100	98	150
Vertical riser W11/40-150	148	150
Vertical riser W11/40-200	198	200
Vertical riser W11/40-300	298	200
Vertical riser W11/40-400	398	200
Vertical riser W11/40-500	498	200
Vertical riser W11/40-600	598	200
Vertical riser W11F/40-50	48	-
Vertical riser W11F/40-70	68	-
Vertical riser W11F/40-100	98	-
Vertical riser W11F/40-150	148	-
Vertical riser W11F/40-200	198	-
Vertical riser W11F/40-300	298	-
Vertical riser W11F/40-400	398	-
Vertical riser W11F/40-500	498	-
Vertical riser W11F/40-600	598	-

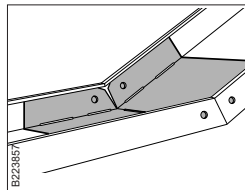
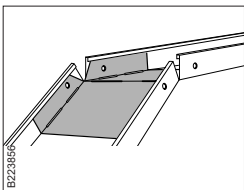

For upward or downward angling to a desired angle up to 90°. Should be locked with Screw set W38P or Locking plug W41.

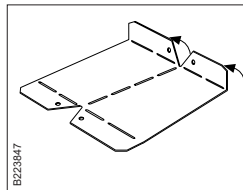

Vertical riser W11/40 is delivered flat and must be bent by the installer on the job site.

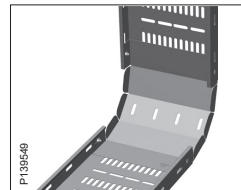

Vertical riser W11F/40 is delivered flat, must be bent to the desired angle by the installer, used for vertical 90° angling. Screw set W38P is used for mounting.

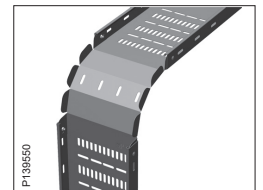

### Vertical riser W11/60

Vertical riser to be used as internal or external riser. Can be bent to the desired angle up to 90°. Push-in installation. The riser is delivered flat.

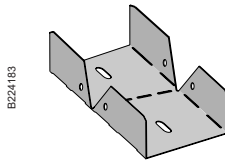

B2241B3

9x19 widths 70, 100, 200 only

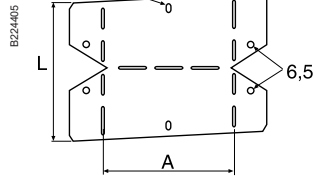

B224405

Type	A mm	L mm
Vertical riser W11/60-70	67	150
Vertical riser W11/60-100	97	150
Vertical riser W11/60-150	147	150
Vertical riser W11/60-200	197	200
Vertical riser W11/60-300	297	200
Vertical riser W11/60-400	397	200
Vertical riser W11/60-500	497	200
Vertical riser W11/60-600	597	200

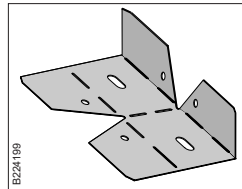

B2241B9

Vertical riser W11/60 is delivered flat and must be bent by the installer on the job site.

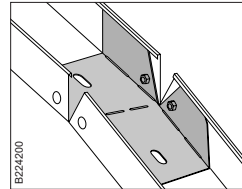

B224200

For upward or downward branching at a desired angle up to 90°. Push-in installation.

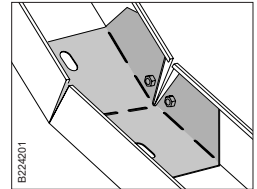

B224201

Should be attached with Screw set W38P or Locking plug W41.

### Vertical riser W4, interior

Vertical riser suitable for installation tray W4. To be used as internal or external riser. The riser is delivered flat and can be bent to the desired angle up to 90°.

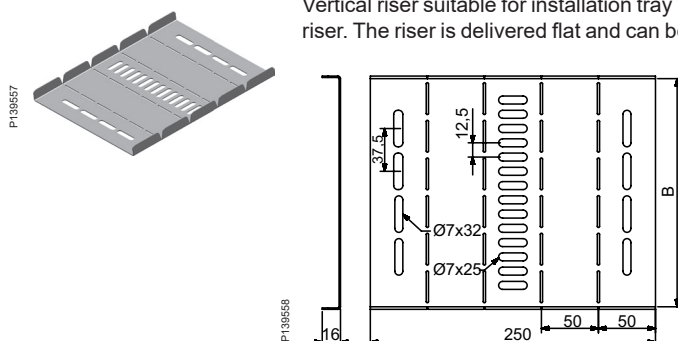

Type	B mm
Vertical riser W4-50	52
Vertical riser W4-75	77
Vertical riser W4-100	102
Vertical riser W4-150	152
Vertical riser W4-200	202
Vertical riser W4-250	252
Vertical riser W4-300	302
Vertical riser W4-400	402

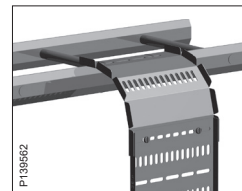
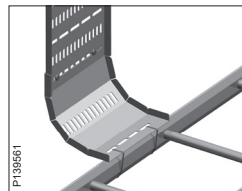

Vertical riser W4 is delivered flat, must be bent to the desired angle by the installer, used for vertical 90° angling. Mounted outside of trays W4. Attached in bottom with Screw set W34 (pre-galvanized, stainless steel and pre-galvanized powder coated trays). For hot dip galvanized trays Screw set W38P must be used.

When used for vertical 90° angling from cable ladder the vertical riser is attached to the cable ladder with strips.

### Adjustable bend W10S/40

Adjustable bend to be used for horizontal angling from 105° to 165° in steps of 7.5°. Push-in installation.

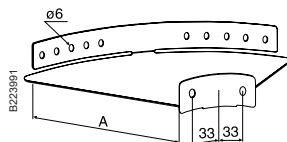
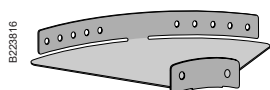

Type	A mm
Adjustable bend W10/40-50	47
Adjustable bend W10/40-70	67
Adjustable bend W10/40-100	97
Adjustable bend W10/40-150	147
Adjustable bend W10/40-200	197
Adjustable bend W10/40-300	297
Adjustable bend W10/40-400	397
Adjustable bend W10/40-500	497
Adjustable bend W10/40-600	597

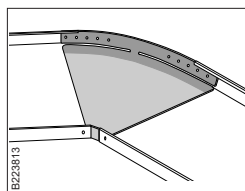

Push-in installation. Turn up inner and outer sides and mount the Adjustable bend W10/40 inside the tray.

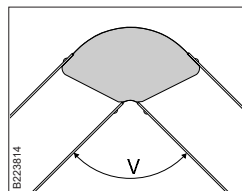

Adjustable bend W10/40 permits desired horizontal angling between 105° and 165° in stages of 7.5°.

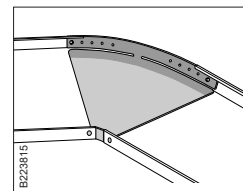

If necessary, Adjustable bend W10/40 may be locked using Screw set W38P or Locking plug W41.

### Adjustable bend W10S/60

Adjustable bend to be used for horizontal angling from 105° to 165° in steps of 7.5°. Push-in installation.

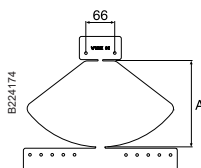
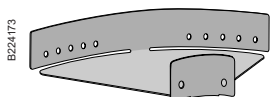

Type	A mm
Adjustable bend W10/60-70	67
Adjustable bend W10/60-100	97
Adjustable bend W10/60-150	147
Adjustable bend W10/60-200	197
Adjustable bend W10/60-300	297
Adjustable bend W10/60-400	397
Adjustable bend W10/60-500	497
Adjustable bend W10/60-600	597

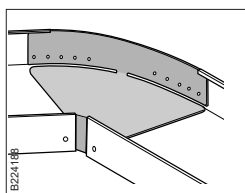

Push-in installation. Turn up inner and outer sides and mount the Adjustable bend W10/60 inside the tray.

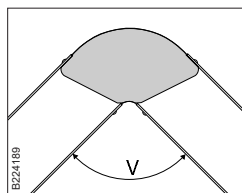

Adjustable bend W10/60 permits desired horizontal angling between 105° and 165° in stages of 7.5°.

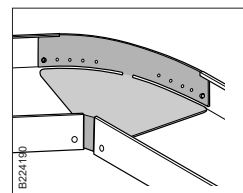

If necessary, Adjustable bend W10/60 may be locked using Screw set W38P or Locking plug W41.

### 90° bend W10/40

Horizontal 90° bend to be used for cable trays W1/40 and W3/40. Push-in assembly.

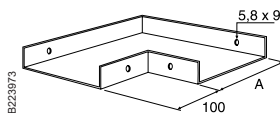
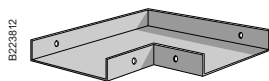

Type	A mm
90° bend W10/40-70	67
90° bend W10/40-100	97
90° bend W10/40-200	197
90° bend W10/40-300	297
90° bend W10/40-400	397
90° bend W10/40-500	497
90° bend W10/40-600	597

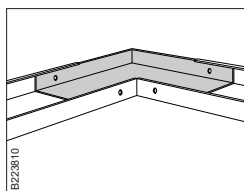

Used for 90° horizontal angling. Suspension components should be mounted in or in connection with the junction. Push-in installation.

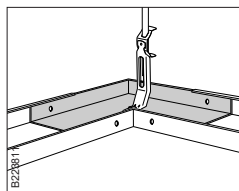

If necessary, the 90° bend W10/40 can be locked using Screw set W38P or Locking plug W41. Can be provided with holes in bottom for suspension in Pendant attachment W21 alternatively W73. Valid for max. width 200 mm.

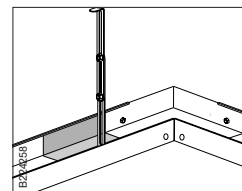

Support bracket/joint W7/40, with a suitable pendant, is used to achieve an invisible suspension, here with End bracket WN17 mounted as vertical piece.

### 90° bend W10/60

Horizontal 90° bend to be used for cable trays W1/60 and W3/60. Push-in assembly.

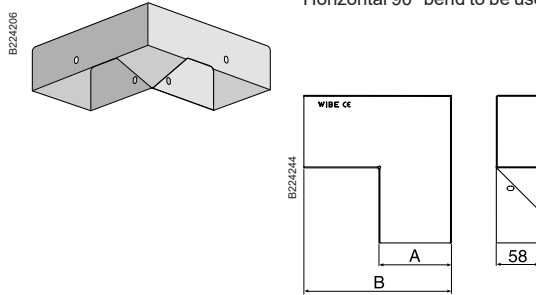

Type	A mm	B mm
90° bend W10/60-70	67	167
90° bend W10/60-100	97	197
90° bend W10/60-150	147	247
90° bend W10/60-200	197	297
90° bend W10/60-300	297	397
90° bend W10/60-400	397	497
90° bend W10/60-500	497	597
90° bend W10/60-600	597	697
90° bend W10/60-500 FS	497	597
90° bend W10/60-600 FS	597	697

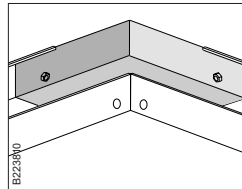

Used for 90° horizontal angling. Suspension components should be mounted in or in connection with the bend. Push-in installation.

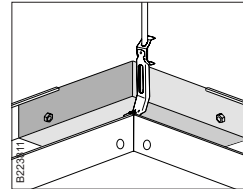

If necessary, the 90° bend W10/60 can be locked using Screw set W38P or Locking plug W41. Can be provided with holes in bottom for suspension in Pendant attachment W21 alternatively Tube pendant attachment W73. Valid for max. width 200 mm.

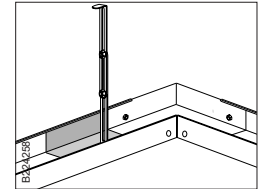

Support bracket/joint W7/60, with a suitable pendant, is used to achieve an invisible suspension, here with End bracket WN17 mounted as vertical piece.

### 90° bend W10F/40

Horizontal 90° bend to be used for cable trays W3/40. Push-in assembly.

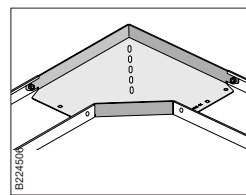
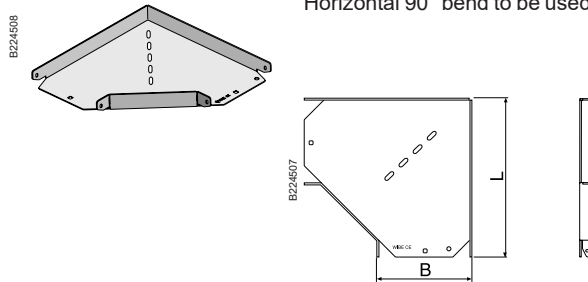

Used for 90° horizontal angling. Suspension components should be mounted in or in connection with the junction. Push-in installation.

Type	B mm	L m
90° bend W10F/40-50	47	119
90° bend W10F/40-70	67	153
90° bend W10F/40-100	97	204
90° bend W10F/40-150	147	290
90° bend W10F/40-200	197	375
90° bend W10F/40-300	297	480
90° bend W10F/40-400	397	580
90° bend W10F/40-500	497	714
90° bend W10F/40-600	597	814

### 90° bend W4

90° bend to be used for cable tray W4. To be mounted on the outside of the tray and attached in the bottom segment with screw set W34.

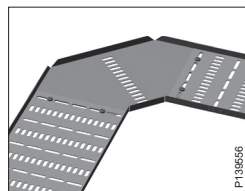
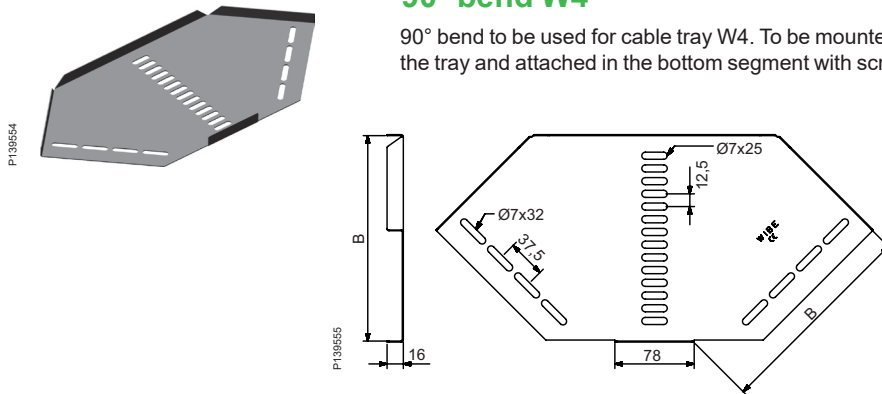

Used for horizontal 90° angling. Mounted outside of W4 trays. Attached in bottom with Screw set W34 (pre-galvanized, stainless steel and pre-galvanized powder coated trays). For hot dip galvanized trays Screw set W38P must be used.

Type	B mm
90° bend W4-50	52
90° bend W4-75	77
90° bend W4-100	102
90° bend W4-150	152
90° bend W4-200	202
90° bend W4-250	252
90° bend W4-300	302
90° bend W4-400	402



### T-junction W12/40

T-junction to be used for 90° horizontal junction of cable trays W1/40 and W3/40. Push-in assembly.

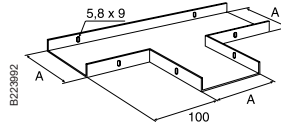
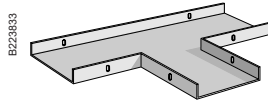

Type	A mm
T-junction W12/40-50	46
T-junction W12/40-70	67
T-junction W12/40-100	97
T-junction W12/40-200	197
T-junction W12/40-300	297
T-junction W12/40-400	397
T-junction W12/40-500	497
T-junction W12/40-600	597

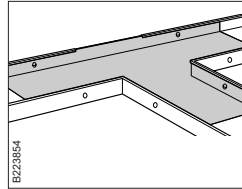

Used for horizontal 90° junction. Suspension components should be mounted in or in connection with the junction. Push-in installation.

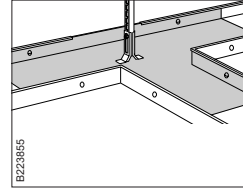

If necessary, the T-junction W12/40 can be locked using Screw set W38P or Locking plug W41. Can be provided with holes in bottom for suspension in Pendant attachment W21 or Tube pendant attachment W73. Valid for max. width 200 mm.

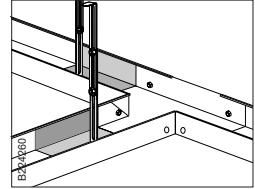

Support bracket/joint W7/40, with a suitable pendant, is used to achieve an invisible suspension, here with End bracket WN17 mounted as vertical piece.

### T-junction W12/60

T-junction to be used for 90° horizontal junction of cable trays W1/60 and W3/60. Push-in assembly.

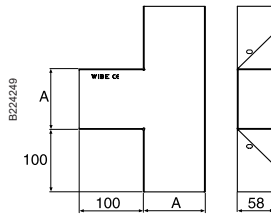
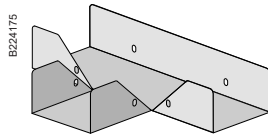

Type	A mm
T-junction W12/60-70	67
T-junction W12/60-100	97
T-junction W12/60-150	147
T-junction W12/60-200	197
T-junction W12/60-300	297
T-junction W12/60-400	397
T-junction W12/60-500	497
T-junction W12/60-600	597
T-junction W12/60-500 FS	497
T-junction W12/60-600 FS	597

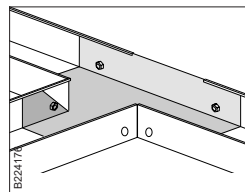

Used for 90° horizontal junction. Suspension components should be mounted in or in connection with the junction. Push-in installation.

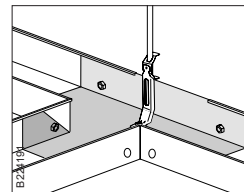

If necessary, the junction can be locked using Screw set W38P or Locking plug W41. Can be provided with holes in bottom for suspension in Pendant attachment W21 alternatively Tube pendant attachment W73. Valid for max. width 200 mm.

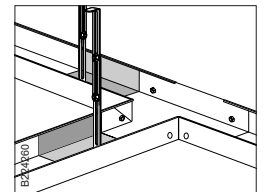

Support bracket/joint W7/60, with a suitable pendant, is used to achieve an invisible suspension, here with End bracket WN17 mounted as vertical piece.

### T-junction W12F/40

T-junction to be used for 90° horizontal junction of cable trays W3/40. Push-in assembly.

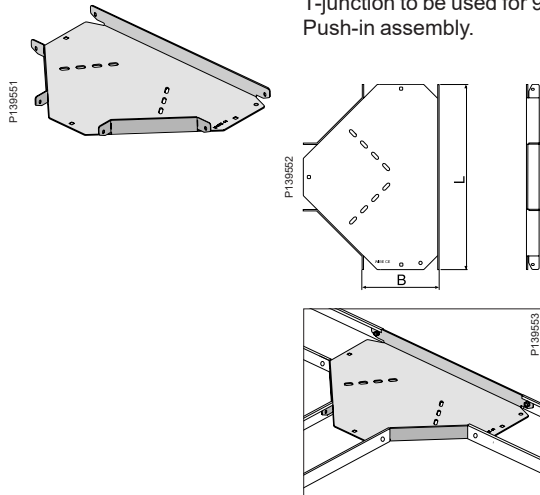

Type	B mm	L m
T-junction W12F/40-50	47	171
T-junction W12F/40-70	67	219
T-junction W12F/40-100	97	312
T-junction W12F/40-150	147	432
T-junction W12F/40-200	197	553
T-junction W12F/40-300	297	662
T-junction W12F/40-400	397	762
T-junction W12F/40-500	497	932
T-junction W12F/40-600	597	1032

Used for horizontal 90° junction. Suspension components should be mounted in or in connection with the junction. Push-in installation.

### X-junction W13/40

X-junction to be used for 90° horizontal junction of cable trays W1/40 and W3/40. Push-in assembly.

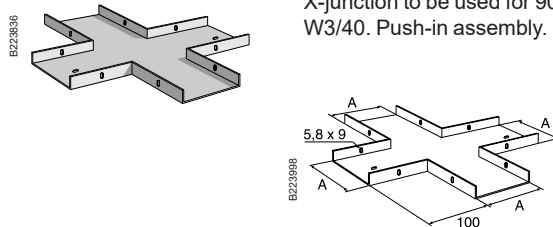

Type	A mm
X-junction W13/40-50	46
X-junction W13/40-70	67
X-junction W13/40-100	97
X-junction W13/40-200	197
X-junction W13/40-300	297
X-junction W13/40-400	397
X-junction W13/40-500	497
X-junction W13/40-600	597

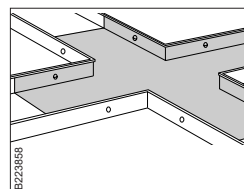

Used for horizontal 90° junction of four trays with the same width. Suspension components should be mounted in or in connection with the junction. Push-in installation.

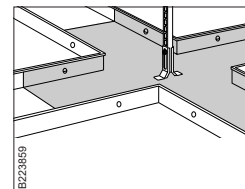

If necessary, the X-junction W13/40 can be locked using Screw set W38P or Locking plug W41. Can be provided with holes in bottom for suspension in Pendant attachment W21 or Tube pendant attachment W73. Valid for max. width 200 mm.

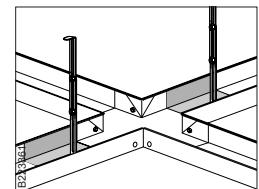

Support bracket/joint W7/40, with a suitable pendant, is used to achieve an invisible suspension, here with End bracket WN17 mounted as vertical piece.

### X-junction W13/60

X-junction to be used for 90° horizontal junction of cable trays W1/60 and W3/60. Push-in assembly.

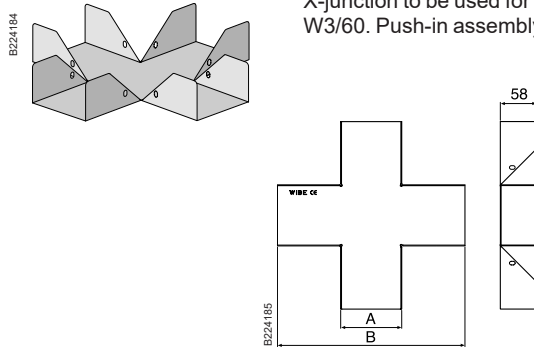

Type	A mm	B mm
X-junction W13/60-70	67	268
X-junction W13/60-100	97	298
X-junction W13/60-150	147	348
X-junction W13/60-200	197	398
X-junction W13/60-300	297	498
X-junction W13/60-400	397	598
X-junction W13/60-500	497	698
X-junction W13/60-600	597	798
X-junction W13/60-500 FS	497	698
X-junction W13/60-600 FS	597	798

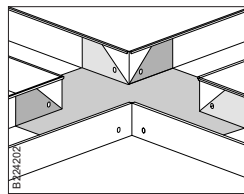

Used for 90° horizontal junction of four trays with the same width. Suspension components should be mounted in or in connection with the junction. Push-in installation.

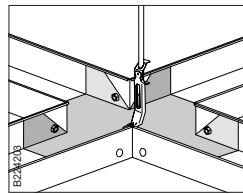

If necessary, the junction can be locked using Screw set W38P or Locking plug W41. Can be provided with holes in bottom for suspension in Pendant attachment W21 alternatively Tube pendant attachment W73. Valid for max. width 200 mm.

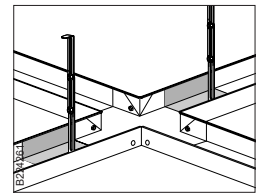

Support bracket/joint W7/60, with a suitable pendant, is used to achieve an invisible suspension, here with End bracket WN17 mounted as vertical piece.

### X-junction W13F/40

X-junction to be used for 90° horizontal junction of cable trays W3/40. Push-in assembly.

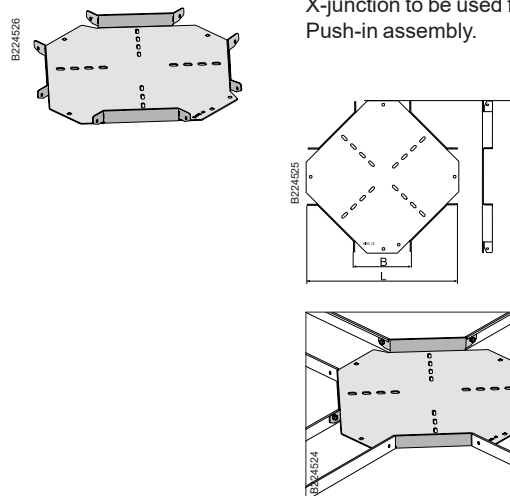

Type	B mm	L m
X-junction W13F/40-50	47	148
X-junction W13F/40-70	67	217
X-junction W13F/40-100	97	313
X-junction W13F/40-150	147	434
X-junction W13F/40-200	197	555
X-junction W13F/40-300	297	662
X-junction W13F/40-400	397	762
X-junction W13F/40-500	497	932
X-junction W13F/40-600	597	1032

Used for horizontal 90° junction of four trays with the same width. Suspension components should be mounted in or in connection with the junction. Push-in installation.

### Reducer W28/40

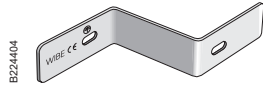

Reducer for 40 mm high cable trays W1 and W3. To be used together with side joint W49 in side transitions. In centered transitions only two reducers W28 are necessary.

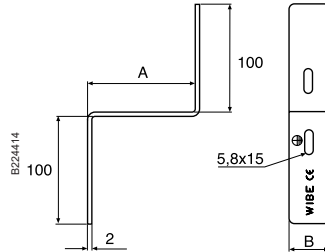

Type	A mm	B mm
Reducer W28/40-50	50	37.5
Reducer W28/40-100,	100	37.5
Reducer W28/40-150	150	37.5
Reducer W28/40-200	200	37.5
Reducer W28/40-250	250	37.5
Reducer W28/40-300	300	37.5
Reducer W28/40-350	350	37.5
Reducer W28/40-400	400	37.5
Reducer W28/40-450	450	37.5
Reducer W28/40-500	500	37.5

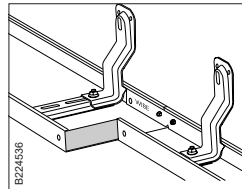

Used together with 1 Side joint W49/40 at one-side transition joining of Cable tray W1/40 and W3/40, to be mounted with 2 Screw sets W38P. Always use support close to the reducer.

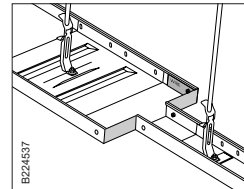

2 Reducers W28/40 are used at centered transition joining, to be mounted with Screw set W38P. Always use support close to the reducer.

### Reducer W28/60

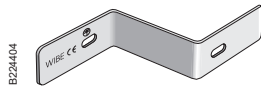

Reducer for 60 mm high cable trays W1 and W3. To be used together with side joint W49 in side transitions. In centered transitions only two reducers W28 are necessary.

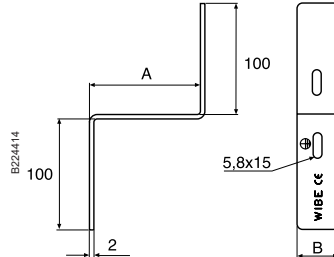

Type	A mm	B mm
Reducer W28/60-50	50	57.5
Reducer W28/60-100	100	57.5
Reducer W28/60-150	150	57.5
Reducer W28/60-200	200	57.5
Reducer W28/60-250	250	57.5
Reducer W28/60-300	300	57.5
Reducer W28/60-350	350	57.5
Reducer W28/60-400	400	57.5
Reducer W28/60-450	450	57.5
Reducer W28/60-500	500	57.5

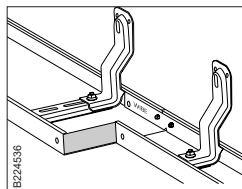

Used together with 1 Side joint W49/60 at one-side transition joining of Cable trays W1/60 and W3/60, to be mounted with 2 Screw sets W38P. Always use support close to the reducer.

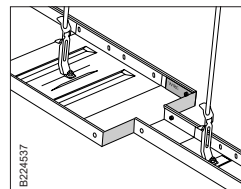

2 Reducers W28/60 are used at centered transition joining, to be mounted with Screw set W38P. Always use support close to the reducer.

### End cover W45/40

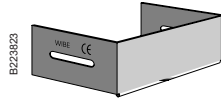

End cover to be mounted at the ends of cable trays W1/40 and W3/40 and of lighting trunking W70. Provided with oval holes 6x55 mm on the sides. Push-in assembly.

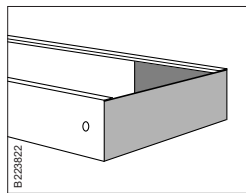
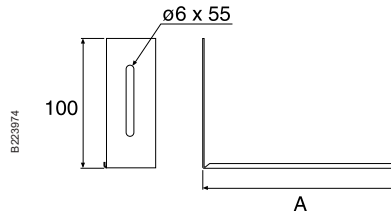

Mounted as end in trays and lighting trunkings. Locked with Locking plug W41 or Screw set W38P.

Type	A mm
End cover W45/40-70	68
End cover W45/40-100	98
End cover W45/40-150	148
End cover W45/40-200	198
End cover W45/40-300	298
End cover W45/40-400	398
End cover W45/40-500	498
End cover W45/40-600	598

### End cover W45/60

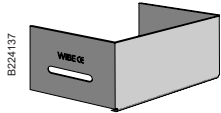

End cover to be mounted at the ends of cable trays W1/60 and W3/60. Provided with oval holes 6x55 mm on the sides. Push-in assembly.

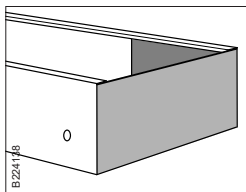
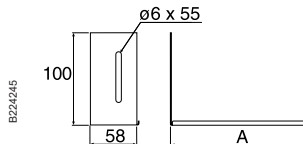

Mounted as end cover in cable trays. Locked with Screw set W38P or Locking plug W41.

Type	A mm
End cover W45/60-70	68
End cover W45/60-100	98
End cover W45/60-200	198
End cover W45/60-300	298
End cover W45/60-400	398
End cover W45/60-500	498
End cover W45/60-600	598



### Junction box plate W24/40

Junction box plate, with or without perforated hole pattern. To be used for the installation of junction boxes, light fittings, etc., in cable trays W1/40 and W3/40 and in lighting trunking W70.

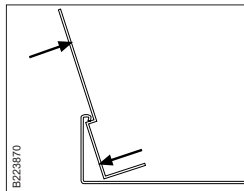
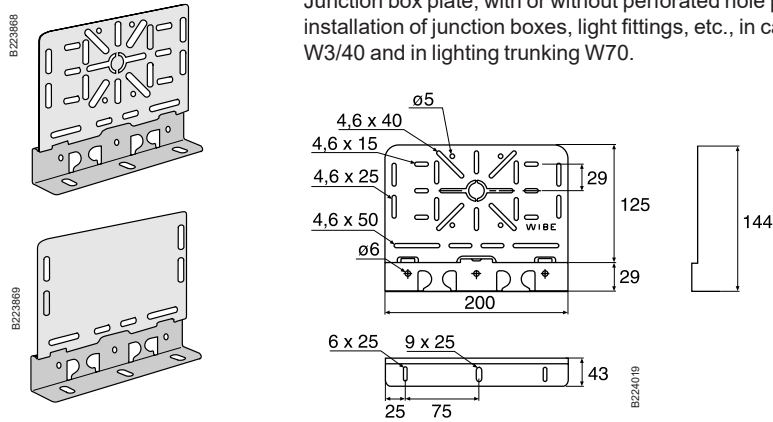

The Junction box plate W24/40 is mounted between the bottom of the trunking or tray and its folded seam.

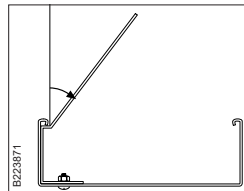

If necessary, the Junction box plate W24/40 can be screwed tight directly in Tray W3/40 with Screw set W38P. If one requires a hidden socket box, the junction box should be folded inwards.

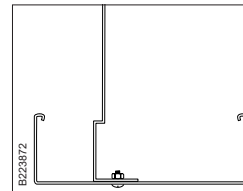

Can be mounted in the middle of Lighting trunking W70-100 and W70-200 with Screw set W36 or Tray W3/40 with Screw set W38P.

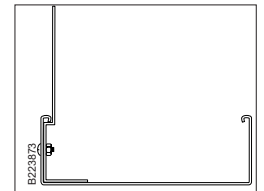

To firmly attach Junction box plate W24/40 in Tray W1/40 or W3/40, use blind rivets, selftapping screws or Screw set W38P.

### Junction box plate W24/60

Junction box plate, with perforated hole pattern. To be used for the installation of junction boxes, light fittings, etc., in cable trays W1/60 and W3/60.

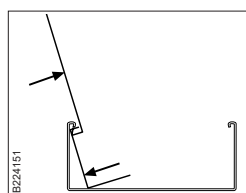
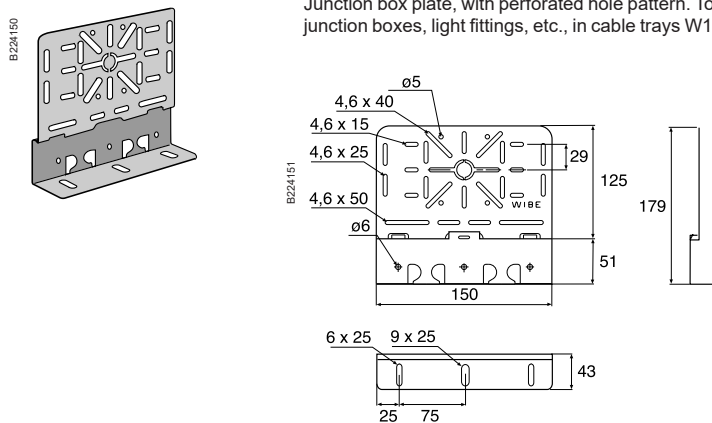

The Junction box plate W24/60 is mounted between the bottom of the tray and its folded seam.

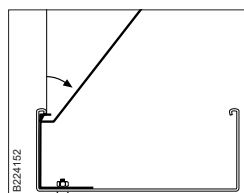

If necessary, the Junction box plate W24/60 can be tightened directly in Tray W3/60 with Screw set W38P. If one requires a hidden socket box, the junction box should be folded inwards.

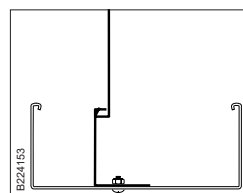

Can be mounted in the middle of Tray W3/60 with Screw set W38P.

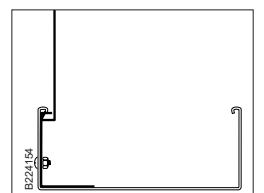

To firmly attach Junction box plate W24/60 in Tray W1/60 or W3/60, use blind rivets, selftapping screws or Screw set W38P.

### Luminaire bracket W25/40

Luminaire bracket to be used for assembly of light fixtures under Cable trays W1/40 and W3/40 or Lighting trunking W70.

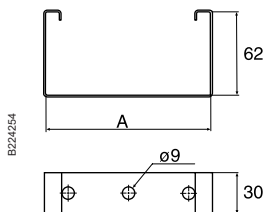
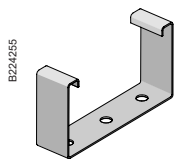

Type	A mm
Luminaire bracket W25/40-70	72
Luminaire bracket W25/40-100	101
Luminaire bracket W25/40-200	201
Luminaire bracket W25/40-300	301
Luminaire bracket W25/40-400	401
Luminaire bracket W25/40-500	501
Luminaire bracket W25/40-600	601

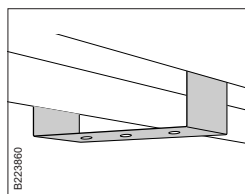

Used for installation of light fittings under tray or trunking. Can easily be moved along the tray or trunking.

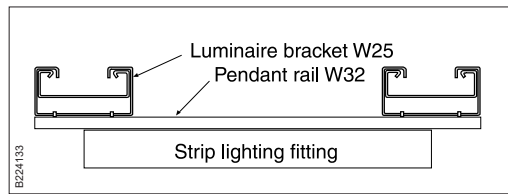

For mounting of light fittings between and under two trays or lighting trunking. The light fitting is easily moved along the tray or lighting trunking.

### Luminaire bracket W25/60

Luminaire bracket to be used for assembly of light fixtures under Cable trays W1/60 and W3/60.

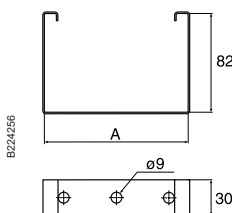
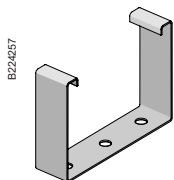

Type	A mm
Luminaire bracket W25/60-70	72
Luminaire bracket W25/60-100	101
Luminaire bracket W25/60-200	201
Luminaire bracket W25/60-300	301
Luminaire bracket W25/60-400	401
Luminaire bracket W25/60-500	501
Luminaire bracket W25/60-600	601

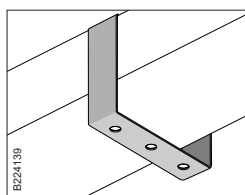

The luminaire bracket can easily be moved along the tray.

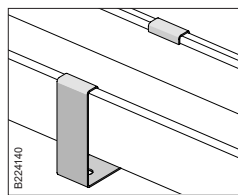

For mounting of lighting fittings under Cable tray W1/60 and W3/60.

### Fixings - Ogebe

The Ogebe fixing is a patented fixing intended for use when mounting plating with a thickness of 0.7-0.9 mm and 13 mm gypsum board. Pendants, cantilevers and holed strips can be mounted with these fittings.

#### Technical data

Material	Cold-rolled sheet steel	Nut	Locking Nut M8, SMS 2165 FZB
	SS 1142-32		
Material treatment	Case-hardened	Bolt	M8 x 16 mm FZB
Surface treatment	Electro-galvanized	Washer	SRB 13.5 x 26 x 2 mm FZB
Maximum load	See load tables		

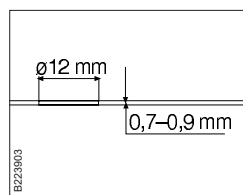

Drill a 12 mm dia. hole. A 10 mm drill can be used if one increases the hole dia. by slanting the electric drill.

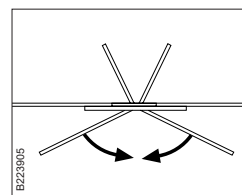

Place the accompanying washer over the thin legs. Insert the legs through the drilled hole and fold the broader legs towards each other. If sealing is required, a standard sealing mass from building retailers can be used.

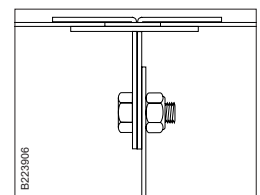

Mount the pendant, bracket or holed strip with the enclosed bolts and nuts. (The nut should always be a locking nut).

#### Breaking load

The load applied at an equi-distance between 2 beams 600 mm apart. The values are taken from Swedish National Testing Institute Report 8410.0032 1984-09-28.

Type of fixing	Sheeting 0.7 mm			Sheeting 0.9 mm			Gypsum 13 mm		
	F1	F2	F3	F1	F2	F3	F1	F2	F3
E	1.01 kN 101 kg	2.14 kN 214 kg	1.85 kN 185 kg	1.77 kN 177 kg	2.43 kN 243 kg	2.05 kN 205 kg			

#### Fixing type E

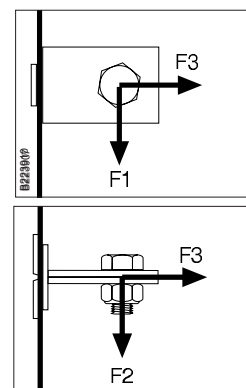

### Ogebe fixing type E

Ogebe fixing type E to be used for mounting in 0.7-0.9 mm sheeting or board material. Examples are hole straps, pendants, ducts, trays and piping.

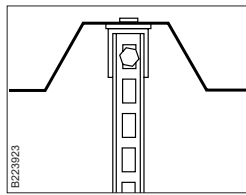
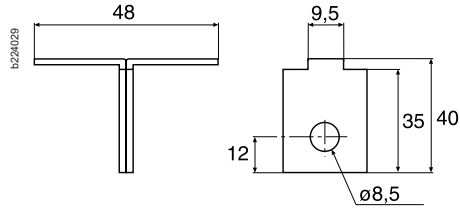
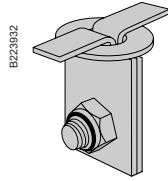

Mounting of Pendant rail W32.

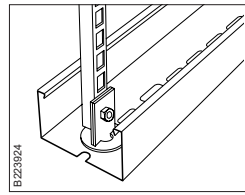

Mounting of Pendant rail W32 with Ogebe fixing type E direct in lighting trunking.

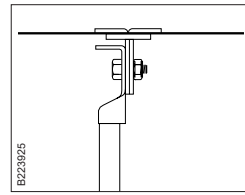

Mounting of Ceiling attachment W31 on Ogebe fixing type E

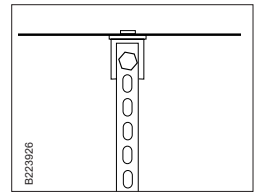

Mounting of hole strap.

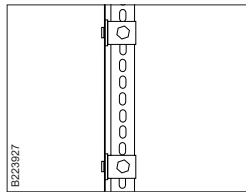

Stand installation on wall.

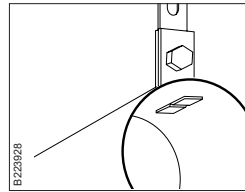

Suspension of duct or pipe.

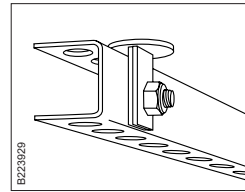

Mounting of holed beam.

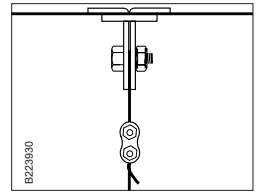

A wire can be mounted directly in the Ogebe fixing type E.

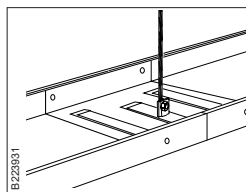

The Ogebe fixing type E can be mounted direct into Support bracket/joint W7.

### Cantilever arm 50i

Cantilever arm to be used for lighter mountings on walls, vertical pieces or pendant/fixing rails.

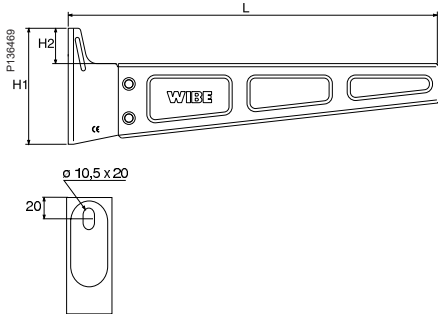

Cantilever arm type	Size		
	L mm	H1 mm	H2 mm
50i-100	150	80	32
50i-200	250	85	28.5
50i-300	350	110	33.5
50i-400	450	115	31.0
50i-500	550	150	31
50i-600	650	150	31

#### Widths = 100

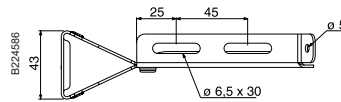

#### Widths = 200

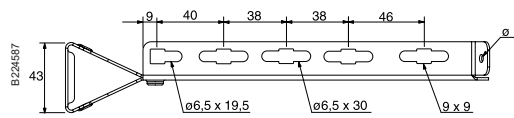

#### Widths = 300

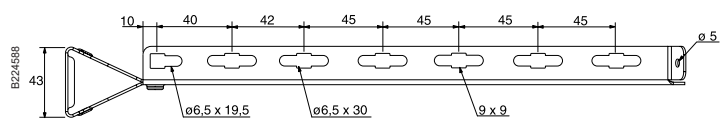

#### Widths = 400

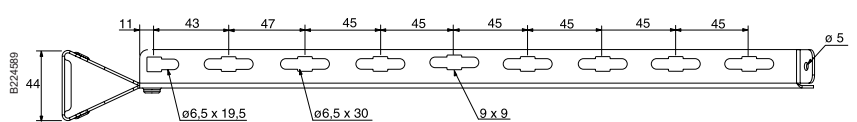

#### Widths = 500

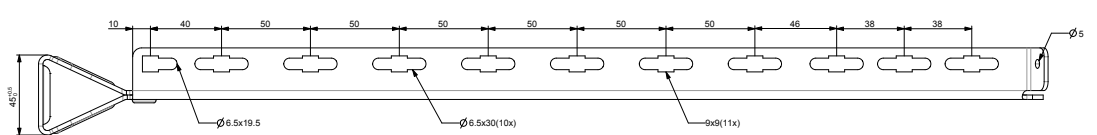

#### Widths = 600

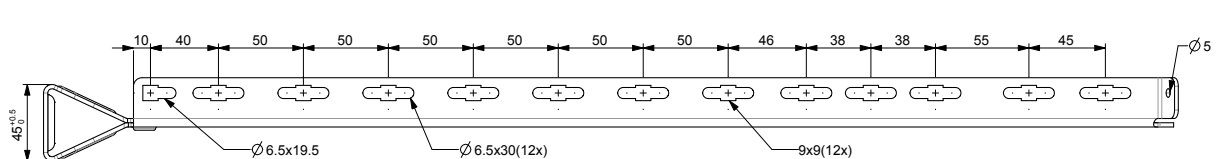

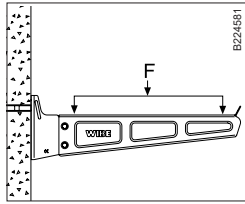

Installation of cantilever arm mounted to wall using Expansion bolt M8. Breaking load - See table below.

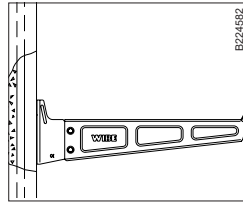

Installation of cantilever arm using T-bolt M8 on Fixing rail 24/26 x 53 for casting-in or Pendant/ Fixing rail wall mounted.

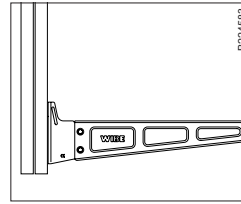

Installation of cantilever arm using T-bolt M8 on vertical piece. Check breaking load of the vertical piece.

### Breaking load F - Mounted on wall

Type	KN	kg
50i-100	2.30	230
50i-200	2.15	215
50i-300	2.20	220
50i-400	2.35	235
50i-500	3.0	300
50i-600	3.0	300

Safe working load according to IEC 61537 is breaking load divided by 1,7.

### Back plate 40

Back plate to be used for installation behind Cantilever arm 50 to reduce the surface pressure on porous walls.

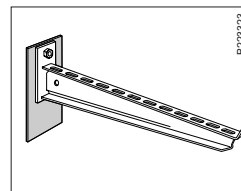
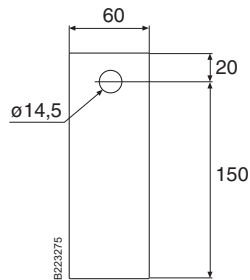
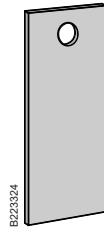

Mount Back plate 40 as shown in the illustration to reduce the surface stress on porous walls.

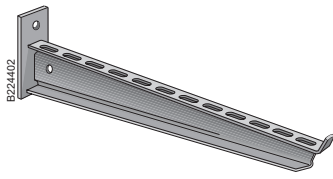

### Cantilever arm 50

Cantilever arm for mounting on walls, pendant/fixing rails or vertical pieces.  
Material: Steel, hot-dip galvanized.

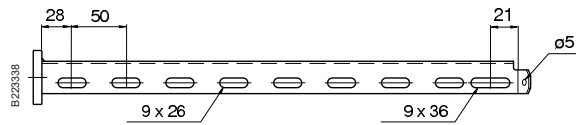
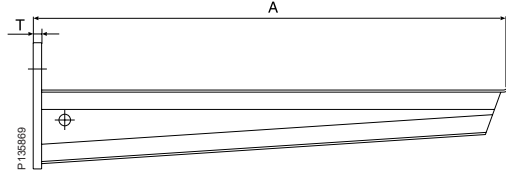

#### 50/100-300

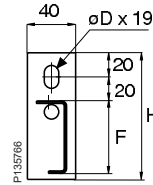

#### 50/400-600

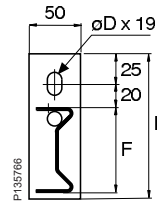

#### 50/700-1000

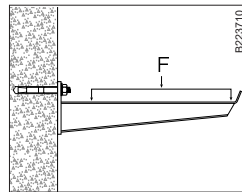
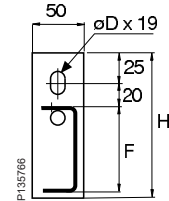

Installation of a Cantilever arm 50 to a wall using an Expansion bolt.  
Breaking load F, see table below.

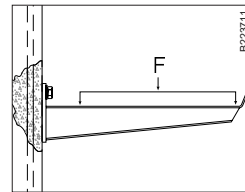

Installation of a Cantilever arm 50 using a T-bolt on pendant/ fixing rail mounted on the wall.  
Breaking load F, see table below.

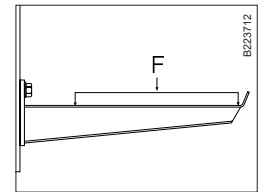

Installation of Cantilever arm 50 using T-bolt with vertical piece. Breaking load F, see table below. Also check the breaking load of vertical pieces.

### Size and Breaking load F

Type	A mm	D mm	F mm	H mm	T mm	Mounted on wall		Mounted on P/F rail 24/48 with T-bolt 26U	
						kN	kg	kN	kg
50/100	150	12	34	85	4	3.0	300	3.0	300
50/150	200	12	36	85	4	3.0	300	3.0	300
50/200	250	12	39	85	4	2.5	250	2.5	250
50/300	350	12	60	105	6	4.0	400	3.0	400
50/400	450	12	70	120	8	6.5	650	4.5	650
50/500	550	12	77	140	8	7.0	700	4.5	700
50/600	650	12	84	150	10	7.0	700	4.0	700



### Pendant/Fixing rail 24/34

Pendant/Fixing rail for mounting of support brackets, cantilever arms, etc.

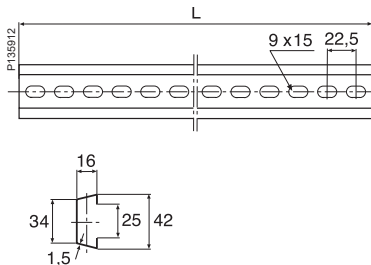

Type	L ± 2 mm
Pendant/Fixing rail 24/34	292.5
Pendant/Fixing rail 24/34	382.5
Pendant/Fixing rail 24/34	495.0
Pendant/Fixing rail 24/34	697.5
Pendant/Fixing rail 24/34	990.0
Pendant/Fixing rail 24/34	2970.0

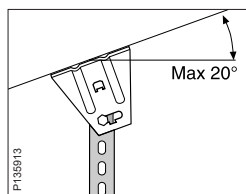

Ceiling bracket 5 and 1 Screw set 22S together provide a vertical piece that can be mounted with up to 20° slope.

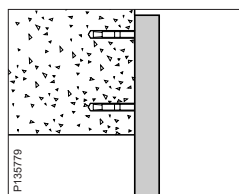

Side mounting of pendant/fixing rails may be done using 2 Expansion bolts alt. 2 Concrete screws.

### Ceiling bracket 5

Ceiling bracket to be used for installations with Pendant/Fixing rails 24/34 and 24/48. Screw not included.

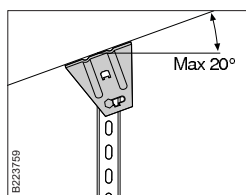
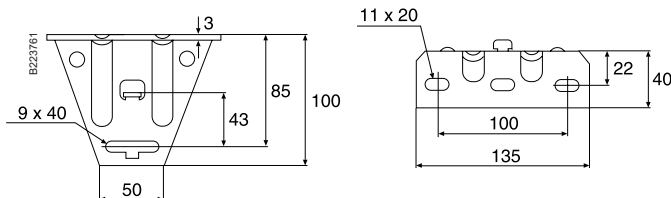
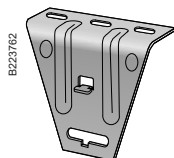

Using Pendant/Fixing rail 24/34 or 24/48, 1 Ceiling bracket 5 and 1 Screw set 22S it is possible to make a vertical piece that can be installed at an angle of up to 20°. Breaking load for rail 34 = 1000 kg (10 kN). Breaking load for rail 48 = 1200 kg (12 kN).

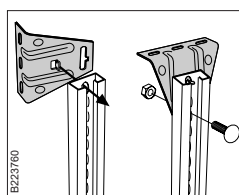

Mount Ceiling bracket 5 to the back of the pendant/fixing rail by turning the ceiling bracket 90° and inserting the tab into the hole in the rail. Then turn the ceiling bracket back and lock it in the required position using 1 Screw set 22S. When mounting it at a horizontal ceiling, lock the screw in the slot recess for better lateral stability. Ceiling bracket 5 can be tilted max. 20°.

### Vertical piece 2

Vertical piece to be used for installation of Support bracket W1940/W1960, symmetrical loading. Can be joined to Pendant/fixing rail 24/34 with Pendant joint 2J.

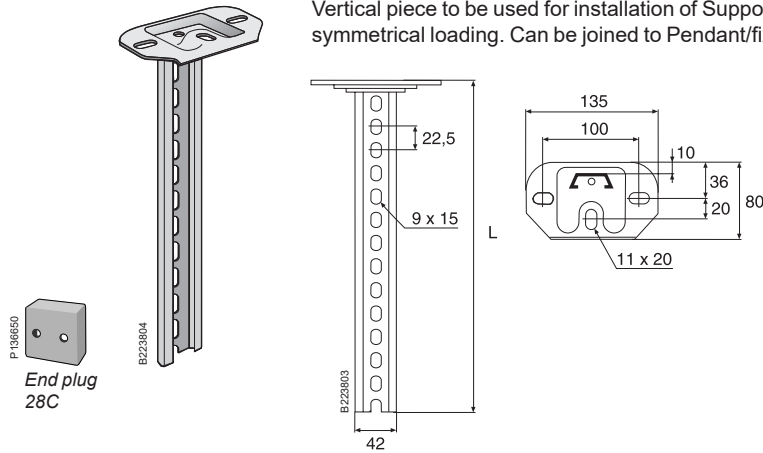

Type	L mm
Vertical piece 2/300	279
Vertical piece 2/400	392
Vertical piece 2/500	504
Vertical piece 2/700	729
Vertical piece 2/1000	1022

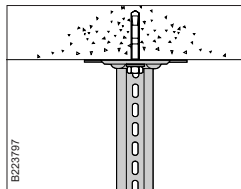

Mount Vertical piece 2 using an Expansion bolt or a concrete screw.

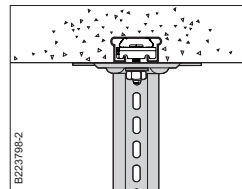

Mount Vertical piece 2 on a Fixing rail 24/26x53 for casting-in using T-bolt 26U.

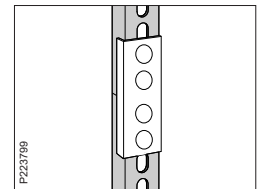

Vertical piece 2 can be joined to achieve the required length using Pendant/Fixing rail 24/34 and Pendant joint 2J.

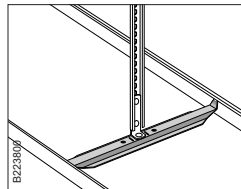

Support bracket W1940/W1960 can be mounted on Vertical piece 2 with Angle bracket W8. Use Screw set W36/W36C.

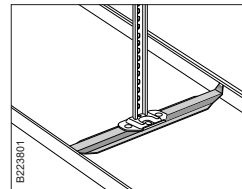

Support bracket W1940/W1960 mounted in the fixing plate of the vertical piece with Screw set W36/W36C.

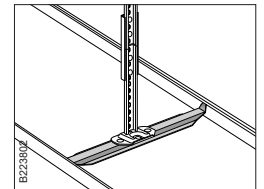

Use Pendant joint 2J to join two Vertical pieces 2.

### Vertical piece 2F

Vertical piece to be used for installation of Internal cantilever arm W17/40, Adjustable cantilever arm W18/40 or Cantilever arm 50/50L. Can be joined to Pendant/fixing rail 24/48 with Pendant joint 2FJ.

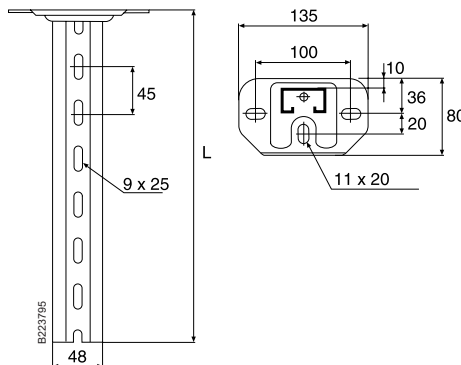
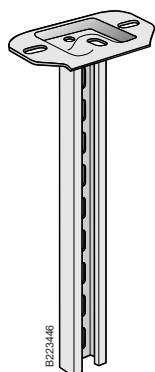

Type	L mm
Vertical piece 2F/280	280
Vertical piece 2F/370	370
Vertical piece 2F/505	505
Vertical piece 2F/730	730
Vertical piece 2F/1000	1000
Vertical piece 2F/1500	1495

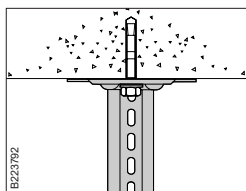

Mounted in ceiling with Expansion bolt alt. Concrete screw.

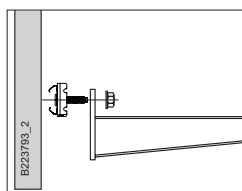

Cantilever arm 50 is mounted with a T-bolt.

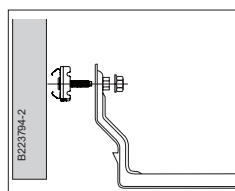

Internal cantilever arm W17/40 is mounted with a T-bolt.

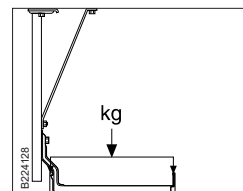

In order to reduce the deflection of Vertical piece 2F for heavy loads on Internal cantilever arm W17/40 and Adjustable cantilever arm W1840/ W1860, Pendant bar 1 is installed.

### End plugs

End plug to be mounted on pendant ends to provide protection against personal injury and to make the ends of the profiles more conspicuous.

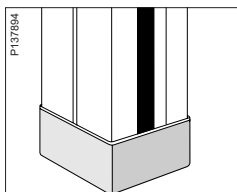
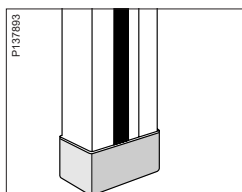
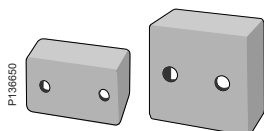

### Pendant bar 1

Pendant bar to be installed in order to reduce the deflection of heavily loaded vertical pieces. Installed with T-bolt and Expansion bolt.

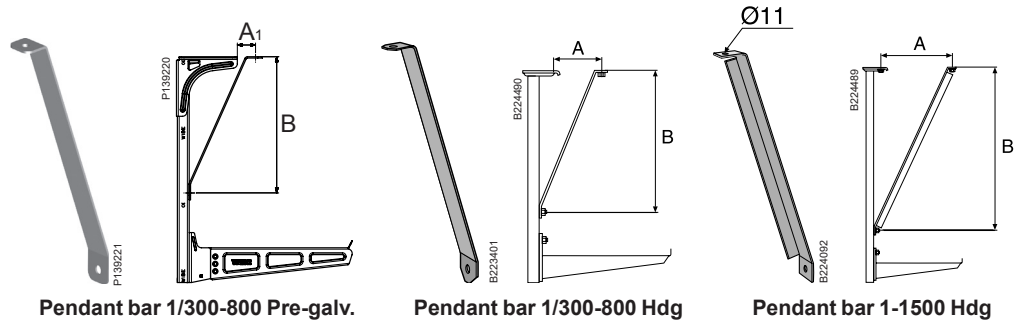

Type	A' mm	A mm	B mm
1/300	40	80	300
1/500	40	130	500
1/800	125	215	800
1/1500	Varies	Varies	Varies

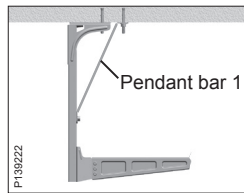

To reduce deflection of Vertical piece 2Fi at heavy loads on Cantilever arm 50i the Pendant bar 1 can be used. Install with T-bolt and Expansion bolt.

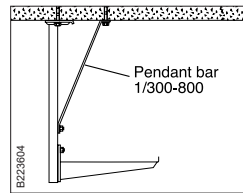

To reduce deflection of Vertical piece 2F at heavy loads on Cantilever arm 50 the Pendant bar 1 can be used. Install with T-bolt and Expansion bolt.

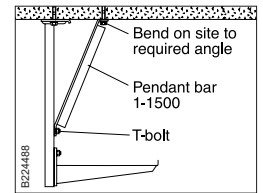

Mount this stay to reduce deflection of long Vertical pieces 2F.

### Pendant joint 2J, 2FJ

Pendant joint to be used for joining pendant/fixing rails and vertical pieces.

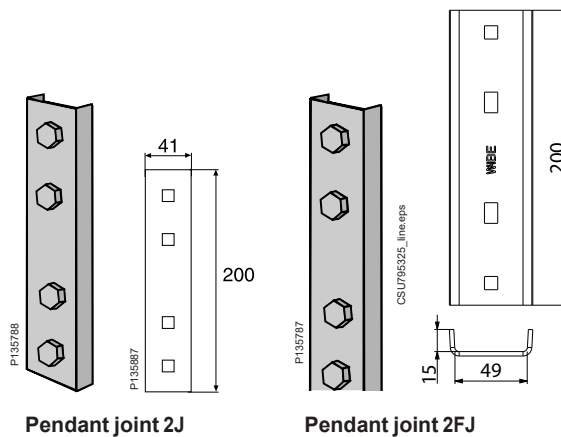

Pendant joint 2J

Pendant joint 2FJ

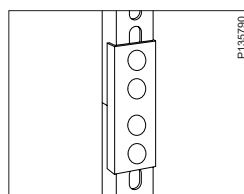

Pendant joint 2J, used for joining of Vertical piece 2 and Pendant/ Fixing rail 24/34.

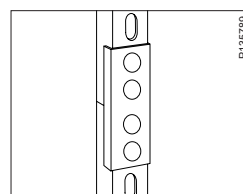

Pendant joint 2FJ, used for joining of Vertical piece 2F, Pendant Fixing rail 24/48 and CLX<sup>3</sup> Pendant Fixing rail 24/48..

### Bracket 60/40

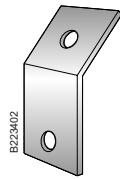

B223402

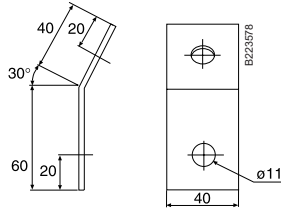

Bracket to be used together with Pendant/fixing rail 24/34 to reduce the deflection of long vertical pieces.

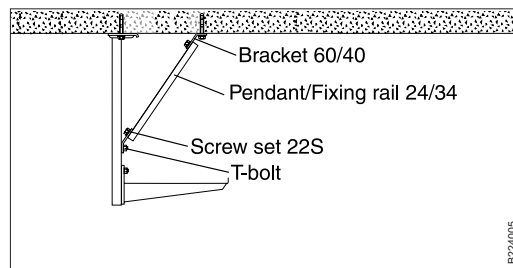

B224005

Use Bracket 60/40 with Pendant/ Fixing rail 24/34 to reduce the deflection of long pendants. Cut the pendant/fixing rail to a suitable length on site.

### Pendant strip W33

Pendant strip to be used as a light-duty vertical ceiling suspension. The pendant strip is delivered in a straight length of 1 m, to be bent on site. Pendants longer than 1 m are joined by overlapping, using Screw set W36/W36C.

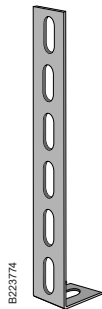

B223774

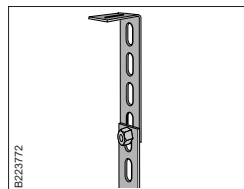
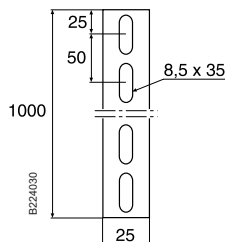

B223772

The Pendant strip W33 is delivered straight. Can be bent on site. Pendants longer than 1 m are joined by overlapping using Screw set W36/W36C.

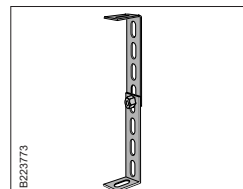

B223773

If adjustment of pendant length is required this can be achieved by cutting the strip in the middle and overlapping the two parts so that a joint can be achieved using Screw set W36/W36C.

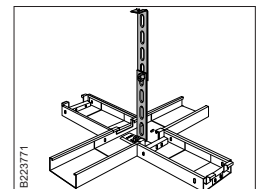

B223771

Mounted in open intersections for ceiling installation. Mounted with Screw set W36/W36C in Support bracket/joint W7.

### Fixing rail 24/26x53 for casting-in

Fixing rail for casting-in in wall and ceilings.

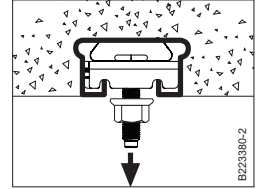
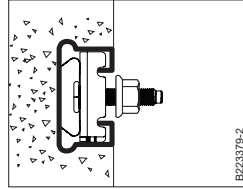
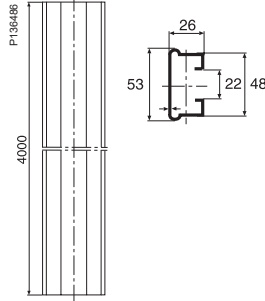
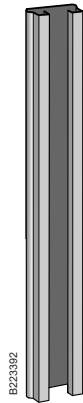

Fixing rail 24/26 x 53 for casting-in in walls and ceilings. Mount cantilever arms with T-bolt 26U.

Max. pull-out load: 1000 kg/0.5 m of casting-in fixing rail (Concrete class K200).

### Locking clamp W77

Locking clamp to be used when pendant rail W32 is mounted between two parallel lighting trunking W70 or cable trays W1/W3 for additional stability.

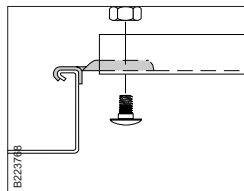
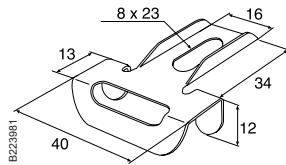
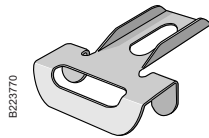

Pendant rail W32 mounted with Screw set W36/W36C or W34.

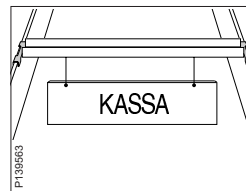

Locking clamp W77 used when Pendant rail W32 is mounted between two Lighting trunking W70 or cable trays as a stabilizer.

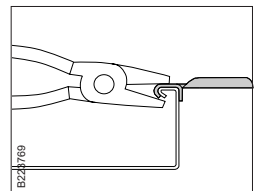

Locking clamp W77 fixed to the fold of trunking/tray with a pair of pliers.

### End bracket WN17

Used as vertical piece, for example mounted on Support bracket/joint W7 to achieve a concealed suspension.

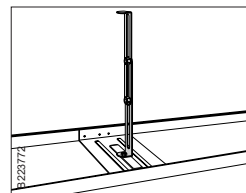
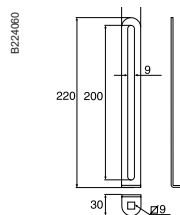
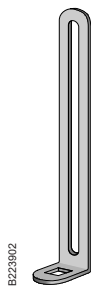

End bracket WN17 can be mounted as vertical piece on Support bracket/joint W7, use Screw set W36/W36C. The end brackets are joined with 2 Screw sets 22S. Max symmetrical load on the end bracket is 100 kg at tightening torque of 10.4 Nm.

### Angle bracket W8

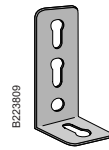

Angle bracket to be mounted inside a cable tray W1/W3 for horizontal installation to the wall or vertical installation to the floor. Can also be mounted as a pendant bracket in the lighting trunking W70.

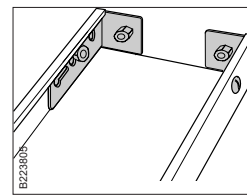
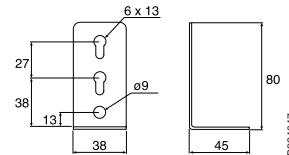

2 Angle brackets W8 are mounted in Cable trays W1/40 or W3/40 using 2 Screw sets W38P for horizontal connection to wall and vertical connection to floor. Can be mounted with legs pointing inwards or outwards.

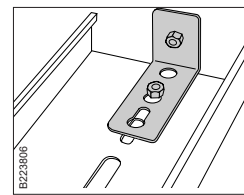

Angle bracket W8 mounted in bottom of lighting trunking with Screw set W36/W36C. Expansion bolts are used for installation in concrete walls. In sheet metal walls mounting is achieved with an Ogebe fixing type ED.

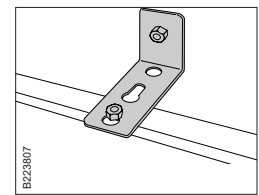

The Angle bracket W8 is mounted to achieve clearance from wall or where there is a large asymmetric load on the tray at pendant installation. Mounted at a distance of 1.5-2 m.

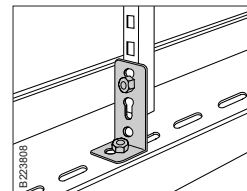

Angle bracket mounted in bottom of lighting trunking with Screw set W36/W36C as pendant attachment.

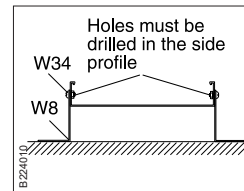

Horizontal installation of Cable tray W3/W1 on floor or vertically on wall. The angle bracket W8 can be turned to reduce the distance to floor or wall.

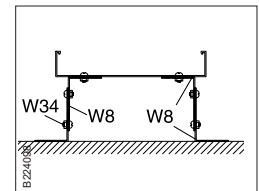

Horizontal installation of Cable tray W3 on floor or vertically on wall. The angle bracket W8 can be turned to reduce the distance to floor or wall.



### Angle bracket W8S

Universal angle bracket to be used for various installations of pendant/fixing rail 24/34, support bracket, etc.

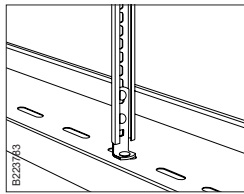
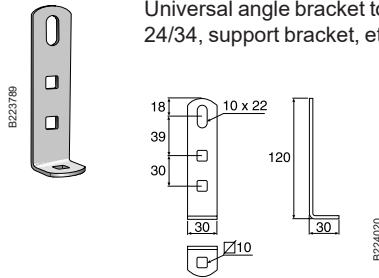

Vertical piece 2 or Pendant/Fixing rail 24/34 can be mounted with Angle bracket W8S directly into the lighting trunking. Use Screw set 22S.

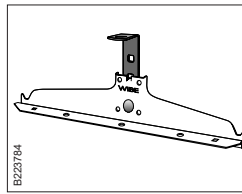

Support bracket 3 can be mounted in ceilings with Angle bracket W8S and Screw set 22S.

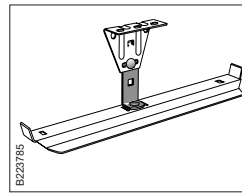

Support bracket W1940/W1960 can be mounted on Ceiling bracket 5 with Angle bracket W8S and Screw set 22S.

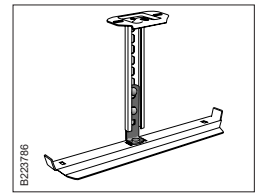

Support bracket W1940/W1960 can be mounted on Vertical piece 2 with Angle bracket W8S and Screw set 22S.

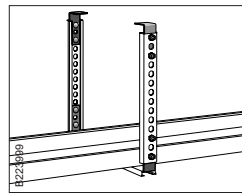

Clamp suspension of cable tray can be made with Pendant/Fixing rail 24/34, Angle bracket W8S and Screw set 22S.

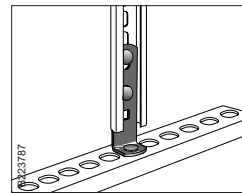

Angle bracket W8S can be used for installations in Pendant/Fixing rail 24/34. Use Screw set 22S. An easy way to build stands for electrical cabinets.

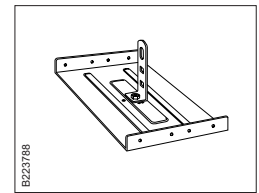

Support bracket/joint W7 can be mounted directly on Vertical piece 2 with Angle bracket W8S and Screw set 22S. Does not apply to widths used for joining only.

### Lashing wire

Lashing wire to be used for lashing of cables on mounting rails or cable ladders.



Type		Diam mm	Breaking load kg
HTR - 2303	Lashing wire, stainless steel, white PVC	1.25	92
HTR - 2313	Lashing wire, stainless steel, black PVC	1.25	92
HT - 2304	Lashing wire, white PVC	1.5	25
HT - 2314	Lashing wire, black PVC	1.5	25

### Earth clamp W79

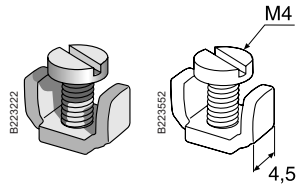

The earth clamp is used when protective earthing of the junction box plate is required.

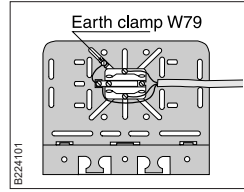

Earth clamps are designed for use when protective earthing of the mounting plate is required for mounting apparatuses as per relevant heavy current directives. The oblong holes in the junction box plate (mounting plate) permit movement of the earth clamp so that it always comes under the casing of the apparatus. If the apparatus's earth clamp is not approved for joining protective earth conductors, it must pass unbroken through the apparatus's earth clamp to the junction box earth clamp (see the fig.).

### Cover plate W16

Cover plate to be used to level out the differences in level between cable tray and junctions, such as 90° bends, T- and X-junctions. To be mounted under the junctions.

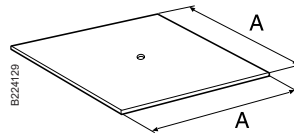
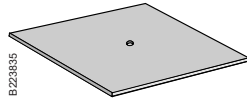

Type	A mm
Cover plate W16-70	70
Cover plate W16-100	100
Cover plate W16-200	200
Cover plate W16-300	300
Cover plate W16-400	400

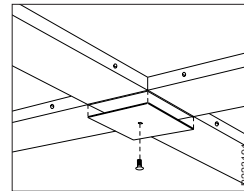

Mounted with Screw set W36/W36C under X-junction W13/40 if one needs to level out differences in height between tray and bend.

### Strip fixing W44

The Strip fixing W44 enables strapping of cables in an unperforated tray.

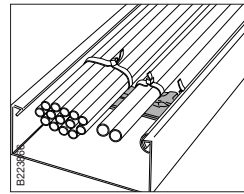
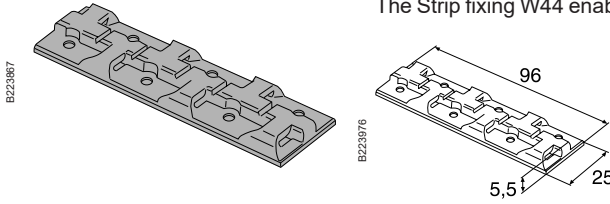

The Strip fixing W44 is provided with double sided adhesive tape and is attached to the tray bottom. Alternatively, blind rivets or self-tapping screws can be used.

When mounting with double sided adhesive tape, the surface on the tray bottom must be wiped clean. Loads may not be applied until after 24 hours. Full adhesion is obtained after 72 hours in 21°C. Ideal application temperature is 21°-38°C. Application below normal room temperature not recommended.

Each Strip fixing W44 can be split up in 2 to 6 pieces. Supplied with 50 pieces in a plastic bag.

### Protection strip W48

Used to protect the cables from damage.

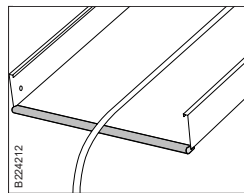
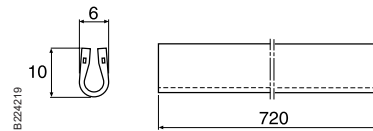
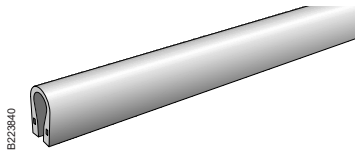

When cutting a cable tray you can mount Protection strip W48 to protect the cables from damage.

### Luminaire bracket W50

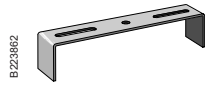

B223862

Luminaire bracket to be used to mount lighting fixtures between two parallel Cable trays W1/W3 or Lighting trunking W70. Dimension A (\* height) is specified when ordering and is depending on the height of the lighting fixture.

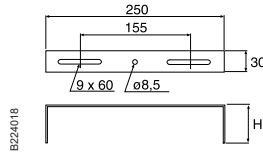

B224018

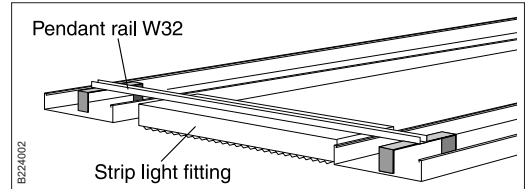

B224002

### Luminaire bracket W35

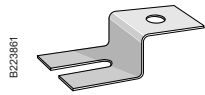

B223861

Luminaire bracket to be used to fix centralized lighting fixtures under Lighting trunking W70.

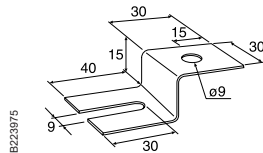

B223875

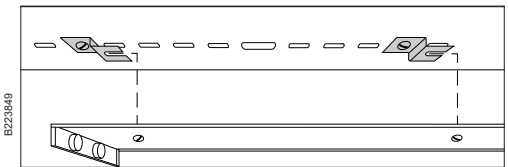

B223849

Mounted in the rail's module holes with Screw set W36/W36C or W34.  
Note! The fork openings must be mounted in the same direction.

### Luminaire bracket W55

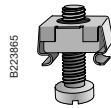

B223865

Luminaire bracket to be used to mount lighting fixtures under Lighting trunking W70.

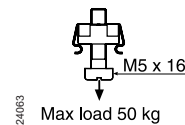

B224083

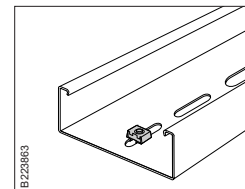

B223863

Mounted in the mounting holes in Lighting trunking W70.

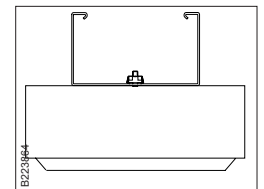

B223864

Always mount the Luminaire bracket W55 from above so that it rests in the tray.

### Shade ledge W26/40

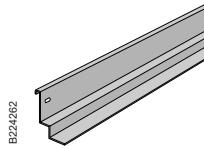

B224262

Shade ledge to be used as a support for ceilings mounted between cable trays with system height 40 mm. Suspended over the lateral side of the cable tray. Also suitable for Lighting trunking W70.

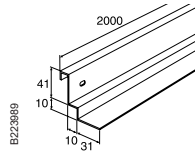

B223889

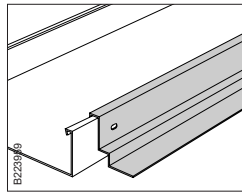

B223989

Shade ledge W26/40 is hung over the side edge of the cable tray.

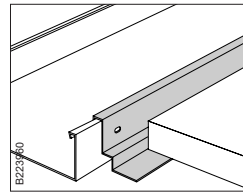

B223960

Shade edge W26/40 is used as a support for ceilings mounted between cable trays. Also suitable for Lighting trunking W70. Mounted along the side edges of the cable tray or the lighting trunking.

### Shade ledge W26/60

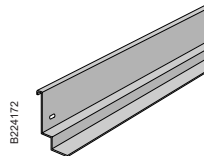

B224172

Shade ledge to be used as a support for ceilings mounted between cable trays with an edge height of 60 mm. Suspended over the lateral side edge of the cable tray.

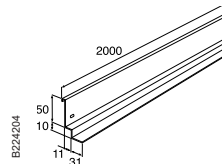

B224204

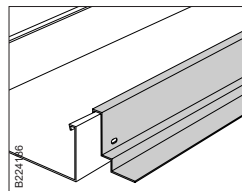

B224166

Shade ledge W26/60 is hung over the side edge of the cable tray.

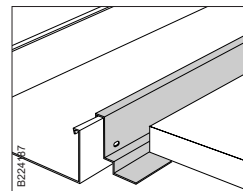

B224167

Shade edge W26/60 is used as a support for ceilings mounted between cable trays. Mounted along the side edges of the cable tray.

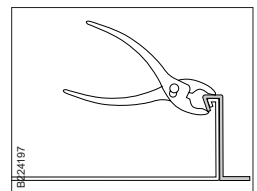

B224197

Shade list W26/40 and W26/60 can be locked tight in the tray by pinching the ends in under the tray edge with pliers.

### Integrated ceiling support channel W27/40

Integrated support channel to be used as a support for false ceilings mounted between cable trays with system height 40 mm. Suspended over the lateral side of the cable tray. Also suitable for Lighting trunking W70.

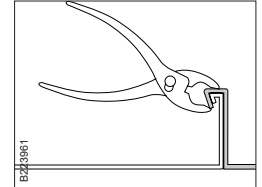
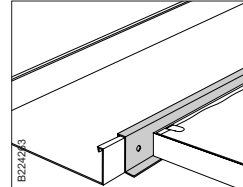
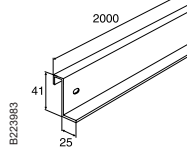
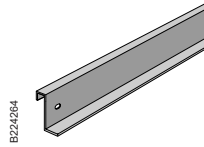

Integrated ceiling support channel W27/40 is hung over and mounted along the side edge of the cable tray and is used as a support for ceilings mounted between cable trays. Also suitable for Lighting trunking W70.

Integrated ceiling support channel W27/40 is locked tight in the tray by pinching the ends in under the tray edge with pliers.

### Integrated ceiling support channel W27/60

Integrated support channel to be used as a support for false ceilings mounted between cable trays with system height 60 mm. Suspended over the lateral side of the cable tray.

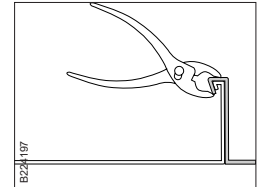
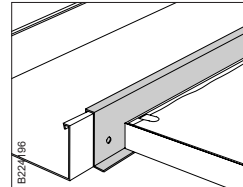
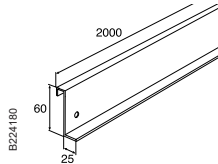
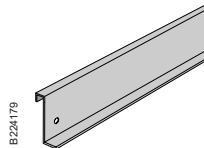

Integrated ceiling support channel W27/60 is used as a support for ceilings mounted between cable trays. Mounted along the side edge of the cable tray.

Integrated ceiling support channel W27/40 and W27/60 can be locked tight in the tray by pinching the ends in under the tray edge with pliers.

### Angle strip W46

Angle strip to be used as a support for installations of false ceilings. To be mounted directly onto a wall, or to the construction of the building.

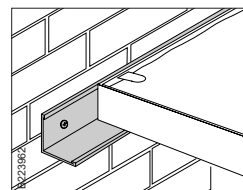
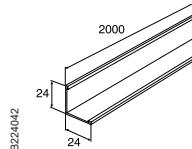
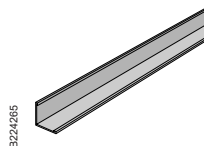

Angle strip W46 is mounted directly onto wall, column or similar as a support for baffles or ceiling lamina.

### T-bolt 26U



T-bolt to be used for mounting with all vertical pieces (except Vertical piece 2) and with Pendant fixing rail 24/48.

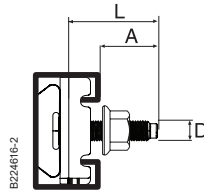

Type	L mm	A mm
M8	34	23
M10	34	23
M10	44	33
M10	54	43

#### Max permitted extraction force

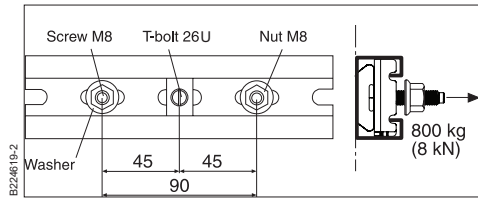

T-bolt 26U M8/M10 + P/F-rail 24/48 + Washer 8.4x19x1.5

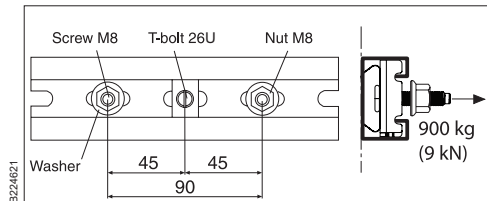

T-bolt 26U M8 + P/F-rail 24/48 + Washer 9x35x2

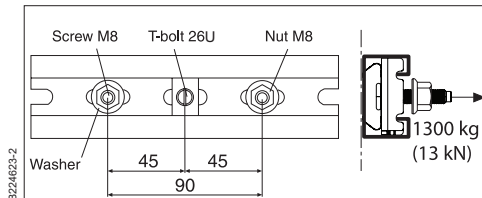

T-bolt 26U M10 + P/F-rail 24/48 + Washer 9x35x2



### Screw set 22S

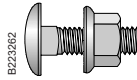

Screw set to be used for installation of Ceiling bracket 5 on Pendant/fixing rails 24/34 and 24/48, Angle bracket 5L against the back of Pendant/fixing rails, Pendant/fixing rails back to back. Set including screw MVBF 8x16 and nut M6MF8.

### Screw set W34



Screw set to be used for mounting of Angle bracket W8 onto Pendant rail W32 and for joining of W4 Installation trays. Set including screw MSCS 6x12 and nut M6MF6.

### Screw set W36



Screw set including bolt and nut M8 to be used for the mounting of single Pendant attachment W21 or on Support bracket/joint W7.

### Screw set W36C



Screw set including bolt with slotted screw head and nut M8. To be used for the mounting of single Pendant attachment W21 or Tube pendant attachment W73 on Support bracket/joint W7.

### Screw set W37

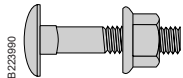

Screw set including bolt MVBF 8x35 and nut M6MF 8, to be used for assembly of Pendant attachment W21 and Ceiling attachment W31 with Pendant rail W32, and for the joining of Pendant rail W32.

### Screw set W38P

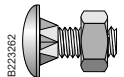

Screw set including screw and nut, to be used for the mounting of joints, bends, junctions, shade ledge W26 and integrated ceiling support channel W27. The patented screw set pierces through painted surfaces securing potential balancing. N.B. The joints must be unpainted.

### Screw W40



For locking of T-joint W29 in open junctions.

### T-bolt 26U



T-bolt to be used for mounting with all vertical pieces (except Vertical piece 2) and with Pendant fixing rail 24/48.

### Locking plug W41

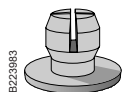

Locking plug to be used for quick locking of joints, bends and branches in cable trays and lighting trunking.

## 70

705093	60
709021	33, 61, 70, 75
<b>71</b>	
713153	59
713177	60
713178	60
713251	16
713252	16
713254	16
713256	16
713257	16
713258	16
713684	33, 61, 71
713685	33, 61, 71
713686	33, 61, 71
713687	33, 61, 71
713694	56, 66
713911	25
713912	25
713913	25
713914	25
713916	25
713917	25
713918	25
714029	68
715646	27, 47
715650	25, 45
715879	59
716283	68
716284	68
716285	68
716286	68
716287	68
716293	69
716295	69
716303	70
716304	70
716306	69
716309	69
716407	57, 66
716474	29, 49
716630	32
716634	28
716640	25, 45
716792	28
716793	28
716797	26
716798	32
716799	27
716799	47
716816	31
716821	32
716824	18, 38, 53
716833	21
716834	21
716835	21
716836	21
716837	21
716911	30
716912	30
716913	30
716914	30
717001	58
717021	19
717022	19
717023	19
717024	19
717069	57, 67
717191	59
717192	59
717193	59
717194	59
717195	59
717196	59
717197	59
717198	59
717199	59
717200	59
717201	68
717202	68
717203	68
717204	68
717205	68

717637	33, 61
717640	60
717641	60
717642	60
717643	70
717644	70
717645	70
717903	21
717904	21
717905	21
717906	21
717907	21
717908	22
717909	22
717910	22
717911	22
717912	22
717913	22
717914	22
717915	22
717916	22
717917	22
717950	38
717990	26
717995	25
718036	22
718037	22
718038	22
718039	22
718040	22
718193	25
718205	20
718360	30
718361	30
718445	19
718446	19
718447	19
718448	19
718469	33, 51, 61, 71
718473	27, 47
718556	26
718559	26
718640	59
718645	47, 57, 66
718645	27
718711	29
718828	18, 39
718829	18, 39
718830	18, 39
718831	18, 39
718832	18, 39
718833	18, 39
718834	18, 39
718835	18
718903	60
718904	60
<b>72</b>	
720520	25
720530	70
720531	70
720785	45
720822	16
720825	19
720970	29
720973	29
720979	26, 46
720984	16
720985	16
720990	19
721101	31
721102	32
721180	29
721184	21
721186	22
721188	22
721786	31
721868	27, 47
721943	29
723180	19
723196	21
723198	22
723200	22
723219	16
723226	23
723227	23

723228	23
723229	23
723230	23
723231	23
723232	23
723432	58
723433	58
723434	58
723436	58
723437	58
723438	58
723439	58
723440	67
723441	67
723442	67
723444	67
723445	67
723446	67
723447	67
723938	57, 67
723974	16
723975	16
723976	16
723977	16
724806	28, 48
724807	73
724942	40
724943	40
724944	40
724945	40
724946	40
724947	40
724948	40
724965	21
724966	21
725079	28, 48
725083	28, 48
725084	73
725085	57, 67
725357	32
725358	32
725359	32
725360	32
725361	32
725362	31
725557	74
725558	74
725559	74
725560	74
725561	74
725562	74
725563	74
725564	74
725565	74
725566	74
725573	74
725574	74
725575	74
725576	74
725577	74
725578	74
725579	74
725580	75
725581	73
725582	73
725583	74
725584	74
725585	75
725586	73
725589	73
725618	73
725619	73
725620	73
725622	73
725623	73
725624	73
725625	73
725785	18
725786	38
726484	75
726485	75
726664	16
726665	16
726666	16
726667	16

726873	61
726874	51
726875	75
728071	32
728595	74
728883	61
728986	36
728987	36
728988	36
728989	36
728990	36
728991	36
728992	36
729015	38
729016	38
729017	38
729018	38
729019	38
729020	38
729021	38
729027	49
729028	49
729029	50
729030	50
729031	50
729032	50
729033	50
729034	50
729041	49
729042	49
729043	49
729044	49
729045	68
729046	39
729047	39
729048	39
729049	39
729050	39
729051	39
729052	39
729054	51
729055	48
729058	51
729059	51
729060	46
729061	48
729062	48
729063	51
729066	51
729094	40
729103	41
729104	41
729105	41
729106	41
729107	41
729108	41
729109	41
729126	43
729127	43
729128	43
729129	43
729130	43
729131	43
729132	43
729133	41
729134	41
729135	41
729136	41
729137	41
729138	41
729139	42
729140	42
729141	42
729142	42
729143	42
729144	42
729145	42
729146	42
729147	42
729148	42
729149	42
729150	42
729151	42
729152	42
729154	42

729155	42
729156	42
729157	42
729158	42
729177	44
729178	44
729179	44
729180	44
729181	44
729182	44
729183	44
729184	45
729185	45
729186	45
729187	45
729188	45
729189	45
729190	45
729191	45
729192	46
729193	46
729201	41

## 73

730186	18, 38, 52, 63
730191	53
730247	25
731717	32
731719	60
731721	32
731724	69
731727	74
731730	24
731731	24
731732	24
731733	24
731734	24
731735	24
731736	24
731747	53
731963	25
731964	45
732177	31
732214	18
732215	18
732216	18
732217	18
732218	18
732219	18
732220	18
732221	18
732262	52
732263	52
732264	52
732265	52
732266	52
732267	52
732268	52
732269	52
732983	53
733090	31
733480	21
733485	22
733486	51
733487	59
733498	23
733499	23
734101	43, 55
734102	55
734103	55
734104	55
734105	55
734106	55
734107	55
734108	55
734109	55
734134	38
734211	45
734227	25
734228	45
734401	29
734402	29
734403	29
734452	57
734453	57
734454	57

# Reference number overview

734455.....	57	736608.....	17	782209.....	19	782425.....	42	783047.....	65
734456.....	57	736609.....	17	782210.....	19	782426.....	42	783048.....	65
734457.....	57	736610.....	17	782211.....	19	782427.....	42	783060.....	67
734554.....	19	736613.....	52	782212.....	19	782428.....	42	783061.....	67
734555.....	19	736614.....	52	782216.....	47	782429.....	42	783062.....	67
734572.....	58	736615.....	52	782217.....	20	782430.....	42	783063.....	67
734573.....	58	736616.....	52	782218.....	40	782431.....	42	783064.....	67
734574.....	58	736617.....	52	782267.....	19	782440.....	42	783065.....	67
734575.....	58	736618.....	52	782268.....	21	782441.....	42	783066.....	68
734578.....	58	736619.....	52	782269.....	21	782442.....	42	783067.....	68
734579.....	58	736620.....	52	782270.....	21	782443.....	42	783068.....	68
734580.....	58	736633.....	37	782271.....	21	782444.....	42	783069.....	68
734581.....	58	736634.....	37	782272.....	21	782445.....	42	783107.....	69
734582.....	58	736635.....	37	782273.....	21	782446.....	42	783120.....	69
734583.....	58	736636.....	37	782274.....	21	782447.....	42	783122.....	69
734584.....	21	736637.....	37	782275.....	21	782458.....	21	783124.....	70
734585.....	21	736638.....	37	782276.....	23	782459.....	21	783126.....	70
734591.....	54	736639.....	37	782277.....	23	782460.....	22	783128.....	63
734592.....	54	736640.....	37	782278.....	23	782461.....	22	783130.....	66
734593.....	54	737537.....	37	782279.....	23	782462.....	22	783166.....	49
734594.....	54	737538.....	37	782280.....	23	782463.....	22	783167.....	49
734595.....	54	737539.....	37	782281.....	23	782471.....	41	783168.....	49
734596.....	54	737540.....	37	782282.....	23	782472.....	41	783169.....	49
734597.....	54	737541.....	37	782283.....	23	782473.....	41	783170.....	49
734598.....	54	737542.....	37	782284.....	25	782474.....	41	783171.....	49
734599.....	54	737543.....	37	782285.....	25	782475.....	41	783178.....	20
734617.....	56	737544.....	37	782286.....	25	782476.....	41	783179.....	20
734618.....	60	737545.....	37	782287.....	25	782477.....	41	783180.....	20
734619.....	59	739713.....	51, 71	782288.....	25	782478.....	41	783181.....	20
734620.....	59	<b>76</b>		782289.....	25	782593.....	43	783182.....	20
734622.....	54	768063.....	60	782290.....	25	782594.....	43	783183.....	20
734646.....	56, 66	768738.....	58	782292.....	24	782595.....	43	783184.....	20
735177.....	27, 56, 66	<b>78</b>		782293.....	24	782596.....	43	783185.....	40
735388.....	17	781334.....	36	782294.....	24	782597.....	43	783186.....	40
735389.....	17	781335.....	36	782295.....	24	782598.....	43	783187.....	40
735390.....	17	781336.....	36	782296.....	24	782599.....	43	783188.....	40
735391.....	17	781337.....	36	782297.....	24	782600.....	43	783189.....	40
735392.....	17	781338.....	36	782298.....	24	782614.....	45	783190.....	40
735393.....	17	781339.....	36	782299.....	18	782615.....	45	783191.....	40
735394.....	17	781340.....	36	782300.....	37	782616.....	45	783470.....	72
735395.....	17	781999.....	16	782307.....	37	782617.....	45	783471.....	72
735396.....	17	782000.....	16	782308.....	37	782618.....	45	783472.....	72
735400.....	52	782001.....	16	782309.....	37	782619.....	45	783473.....	72
735401.....	52	782011.....	36	782310.....	37	782620.....	45	783474.....	72
735402.....	52	782012.....	36	782311.....	37	782659.....	45	783475.....	72
735403.....	52	782013.....	36	782318.....	39	782661.....	46	783476.....	72
735404.....	52	782014.....	36	782319.....	39	782662.....	46	783477.....	72
735405.....	52	782015.....	36	782320.....	39	782850.....	64	783487.....	72
735406.....	52	782016.....	36	782321.....	39	782851.....	64	783500.....	27, 47
735407.....	52	782017.....	36	782322.....	39	782852.....	64	783504.....	50
735408.....	52	782018.....	36	782323.....	39	782853.....	64	783505.....	50
735412.....	62	782038.....	21	782324.....	39	782854.....	64	783506.....	50
735413.....	62	782039.....	21	782325.....	39	782855.....	64	783507.....	50
735414.....	62	782040.....	21	782330.....	39	782856.....	64	783508.....	50
735415.....	62	782041.....	21	782332.....	29	782857.....	64	783509.....	50
735416.....	62	782042.....	21	782333.....	29	782858.....	64	783587.....	30
735417.....	62	782043.....	21	782334.....	29	783000.....	66	783588.....	30
735418.....	62	782044.....	21	782335.....	29	783001.....	66	783589.....	30
735419.....	62	782045.....	21	782336.....	29	783002.....	66	783590.....	30
735420.....	62	782046.....	16	782337.....	29	783003.....	66	783591.....	50
735977.....	52	782047.....	16	782342.....	29	783004.....	66	783592.....	50
735978.....	52	782048.....	36	782343.....	29	783005.....	66	783593.....	50
735979.....	52	782049.....	36	782363.....	63	783006.....	66	783594.....	50
735980.....	52	782052.....	22	782364.....	63	783007.....	66	783600.....	64
735981.....	52	782053.....	22	782365.....	63	783018.....	68	783601.....	64
735982.....	52	782054.....	22	782366.....	63	783019.....	68	783602.....	64
735988.....	17	782055.....	22	782367.....	63	783020.....	68	783603.....	64
735989.....	17	782056.....	22	782368.....	63	783021.....	68	783604.....	64
735990.....	17	782057.....	22	782369.....	63	783022.....	68	783605.....	64
735991.....	17	782058.....	22	782370.....	63	783023.....	68	783606.....	64
735992.....	17	782059.....	22	782392.....	30	783030.....	56	783607.....	64
735993.....	17	782095.....	22	782393.....	30	783031.....	56	783608.....	64
735999.....	62	782096.....	22	782394.....	30	783032.....	56	783620.....	64
736000.....	62	782097.....	22	782395.....	30	783033.....	56	783621.....	64
736001.....	62	782098.....	22	782396.....	30	783034.....	56	783622.....	64
736002.....	62	782099.....	22	782397.....	30	783035.....	56	783623.....	64
736003.....	62	782100.....	22	782408.....	41	783036.....	56	783624.....	64
736004.....	62	782101.....	22	782409.....	41	783037.....	56	783625.....	64
736005.....	62	782102.....	22	782410.....	41	783040.....	65	783626.....	64
736006.....	62	782202.....	17	782411.....	41	783041.....	65	783627.....	64
736603.....	17	782203.....	17	782412.....	41	783042.....	65	783628.....	64
736604.....	17	782204.....	17	782413.....	41	783043.....	65	783640.....	65
736605.....	17	782205.....	17	782414.....	41	783044.....	65	783641.....	65
736606.....	17	782206.....	17	782415.....	41	783045.....	65	783642.....	65
736607.....	17	782207.....	17	782424.....	42	783046.....	65	783643.....	65

783644	65	784097	55	791278	53	793672	65	CSU795634	35
783645	65	784098	55	791279	53	793673	65	CSU795635	35
783646	65	784099	55	791280	53	793674	65	CSU795636	35
783647	65	784100	55	791281	53	793675	65	CSU795637	35
783648	65	784101	55	791282	63	793676	65	CSU795638	35, 86
783660	54	784102	55	791283	63	793677	64	CSU795639	35
783661	54	784103	55	791284	63	793678	64	CSU795640	35, 86
783662	54	784104	55	791285	63	793679	64	CSU795641	35, 86
783663	54	784105	43	791286	63	793680	64	CSU795653	35
783664	54	784106	43	791287	63	793681	64	CSU795654	35
783665	54	784107	43	791288	63	793682	64	CSU795660	35
783666	54	784108	43	791289	63	793683	64	CSU795661	35
783667	54	784109	43	791290	63	793684	64	CSU795662	35
783668	54	784110	43	791412	30	<b>114</b>		CSU795663	35
783670	54	784111	43	791413	30	1149405	28, 48	CSU795664	35
783671	54	784112	43	791414	30	1149456	28, 48	CSU795700	35
783672	54	784113	41	791415	30	1149464	28, 48		
783673	54	784114	41	791416	50	1149466	28, 48		
783674	54	784115	41	791417	50	1149551	73		
783675	54	784116	41	791418	50	1149552	73		
783676	54	784117	41	791419	50	1149554	73		
783677	54	784118	41	792554	31	1149561	73		
783678	54	784119	41	792723	31	1149562	73		
783680	55	784120	41	792724	31	1149564	73		
783681	55	786771	44	792725	31				
783682	55	786772	44	792726	31	<b>CSU</b>			
783683	55	786773	44	792727	32	CSU734698	57, 67		
783684	55	786774	44	792728	32	CSU794123	18		
783685	55	786775	44	792729	32	CSU794124	18		
783686	55	786776	44	792934	28, 48	CSU794125	18		
783687	55	786777	44	792935	28, 48	CSU794184	38		
783688	55	786792	30	793571	24	CSU794185	38		
783753	49	786793	50	793572	24	CSU794186	38		
783754	49	786831	16	793573	24	CSU794528	52		
783884	72	786832	16	793574	24	CSU794529	52		
783885	72	786833	36	793575	24	CSU794531	62		
783886	72	786834	36	793576	24	CSU794532	62		
783887	72	786837	19	793577	24	CSU794697	57, 67		
783888	72	786838	39	793578	24	CSU794699	57, 67		
783889	72	786873	38	793579	44	CSU794715	57, 67		
783890	72	787188	41	793580	44	CSU795136	19, 53		
783891	72	787189	41	793581	44	CSU795216	18		
783900	72	787192	42	793582	44	CSU795217	38		
783901	72	787193	42	793583	44	CSU795218	52		
783902	72	787196	42	793584	44	CSU795219	62		
783903	72	787197	42	793585	44	CSU795316	58		
783904	72	787211	33, 51, 61, 71, 75	793586	44	CSU795317	58		
783905	72	787227	37	793587	56	CSU795318	58		
783906	72	787228	37	793588	56	CSU795319	58		
783907	72	787229	37	793589	56	CSU795320	58		
783908	55	787230	37	793590	56	CSU795321	58		
783909	55	787231	37	793591	56	CSU795322	30		
783910	55	787232	37	793592	56	CSU795323	30		
783911	55	787276	59	793593	56	CSU795325	32		
783912	55	787277	68	793594	56	CSU795328	75		
783913	55	787278	74	793595	56	CSU795370	30, 50, 58, 68		
783914	55	787436	24	793596	56	CSU795371	30		
783915	55	787437	24	793597	65	CSU795372	50		
783916	55	787438	44	793598	65	CSU795377	30, 58		
784061	28, 48	787439	44	793599	65	CSU795378	50, 68		
784062	28, 48	787442	24	793600	65	CSU795379	21		
784063	28, 48	787443	24	793601	65	CSU795380	41		
784073	21	787444	44	793602	65	CSU795381	54		
784074	21	787445	44	793603	65	CSU795382	64		
784075	21	788572	20	793604	65	CSU795383	22		
784076	21	788573	53	793605	65	CSU795384	42		
784077	21	788574	39	793606	65	CSU795385	54		
784078	21	788575	63	793607	24	CSU795386	64		
784079	21	789875	33, 61, 70, 75	793608	24	CSU795387	22		
784080	21	<b>79</b>		793609	24	CSU795388	42		
784081	54	790231	63	793610	24	CSU795389	55		
784082	54	790984	20	793611	24	CSU795390	65		
784083	54	790985	20	793612	24	CSU795564	32		
784084	54	790986	20	793613	24	CSU795565	60, 69, 74		
784085	54	790987	20	793614	24	CSU795588	27, 47		
784086	54	790988	20	793615	44	CSU795589	56, 66		
784087	54	790989	20	793616	44	CSU795590	56, 66		
784088	54	790990	20	793617	44	CSU795591	56, 66		
784089	23	791205	28	793618	44	CSU795592	73		
784090	23	791207	48	793619	44	CSU795593	73		
784091	23	791273	53	793620	44	CSU795594	27, 47		
784092	23	791274	53	793621	44	CSU795595	56, 66		
784093	23	791275	53	793622	44	CSU795596	73		
784094	23	791276	53	793669	65	CSU795597	61		
784095	23	791277	53	793670	65	CSU795632	35		
784096	23			793671	65	CSU795633	35		





# Green Premium™

An industry leading portfolio of offers delivering sustainable value



More than 75% of our product sales offer superior transparency on the material content, regulatory information and environmental impact of our products:

- RoHS compliance
- REACH substance information
- Industry leading # of PEP's\*
- Circularity instructions



Discover what we mean by green  
[Check your products!](#)

The Green Premium program stands for our commitment to deliver customer valued sustainable performance. It has been upgraded with recognized environmental claims and extended to cover all offers including Products, Services and Solutions.

#### CO<sub>2</sub> and P&L impact through... Resource Performance

Green Premium brings improved resource efficiency throughout an asset's lifecycle. This includes efficient use of energy and natural resources, along with the minimization of CO<sub>2</sub> emissions.

#### Cost of ownership optimization through... Circular Performance

We're helping our customers optimize the total cost of ownership of their assets. To do this, we provide IoT-enabled solutions, as well as upgrade, repair, retrofit, and remanufacture services.

#### Peace of mind through... Well-being Performance

Green Premium products are RoHS and REACH compliant. We're going beyond regulatory compliance with step-by-step substitution of certain materials and substances from our products.

#### Improved sales through... Differentiation

Green Premium delivers strong value propositions through third-party labels and services. By collaborating with third-party organizations we can support our customers in meeting their sustainability goals such as green building certifications.

\*PEP: Product Environmental Profile (i.e. Environmental Product Declaration)

Life Is On



**Schneider Electric Industries SAS**

35, rue Joseph Monier  
CS 30323  
92506 Rueil Malmaison Cedex  
France

RCS Nanterre 954 503 439  
Capital social 896 313 776 €  
[www.se.com](http://www.se.com)

10-2020

